

Sicherheitshinweise Dreiphasen-Netzmessgerät SIRAX MT7100 / MT7150	2
Safety instructions Three phase meter SIRAX MT7100 / MT7150	3
Instructions de sécurité Mètre triphasé SIRAX MT7100 / MT7150	4
Indicazioni per la sicurezza Misuratore trifase SIRAX MT7100 / MT7150	5
Instrucciones de seguridad Medidor trifásico SIRAX MT7100 / MT7150	6



 **CAMILLE BAUER**

Camille Bauer Metrawatt AG  
Aargauerstrasse 7  
CH-5610 Wohlen / Switzerland  
Phone: +41 56 618 21 11  
Fax: +41 56 618 21 21  
info@cbmag.com  
www.camillebauer.com

# Dreiphasen-Netzmessgerät SIRAX MT7100 / MT7150

## Sicherheitshinweise



Der einwandfreie und gefahrlose Betrieb setzt voraus, dass diese Sicherheitshinweise gelesen und verstanden wurden.

Detailangaben entnehmen Sie bitte aus unserer Betriebsanleitung. Downloadbar von unserer Webpage [www.camillebauer.com](http://www.camillebauer.com)

Der Umgang mit diesem Gerät darf nur durch geschultes Personal erfolgen. Überprüfen Sie vor der Inbetriebnahme, dass:

- die Anschlussleitungen nicht beschädigt und bei der Verdrahtung spannungsfrei sind
- Energierichtung und Phasenfolge stimmen

Das Gerät muss ausser Betrieb gesetzt werden, wenn ein gefahrloser Betrieb (z.B. sichtbare Beschädigungen) nicht mehr möglich ist. Dabei sind alle Anschlüsse abzuschalten. Das Gerät ist an unser Werk bzw. an eine durch uns autorisierte Servicestelle zu schicken.

Ein Öffnen des Gehäuses bzw. Eingriff in das Gerät ist verboten. Das Gerät hat keinen eigenen Netzschalter. Achten Sie darauf, dass beim Einbau ein gekennzeichnete Schalter in der Installation vorhanden ist und dieser vom Benutzer leicht erreicht werden kann.

Das Gerät ist wartungsfrei. Bei einem nicht autorisierten Eingriff in das Gerät erlischt der Garantiesanspruch.

## Anwendungsbereich

Der SIRAX MT7100 und MT7150 sind «All in One» Dreiphasen-Netzgeräte mit integriertem Energiezähler und universellen Stromeingang. Sie sind für den Hutschienenbau konzipiert und lassen sich an gängige Strom- und Spannungswandler und Rogowski Spulen anschliessen. Die Geräte messen RMS AC und DC, durchschnittliche min. und max. Werte, Frequenz, Crest Faktor, harmonische bis zur 63., THD,  $I_{peak}$  und  $U_{peak}$  und viele mehr. Sie sind mit einem seriellen Ausgang RS485 Modbus RTU für Messwerte und einem digitalen Ausgang für Alarmer ausgestattet. Über die kostenlose Konfigurationssoftware lassen sich die Geräte sehr einfach konfigurieren.

## Montage und Installation



Sorgen Sie während der Montage, Installations- und Wartungsarbeiten für eine sichere Arbeitsumgebung. Unterbrechen Sie die Stromzufuhr des Primärleiters und sichern Sie diese gegen unbeabsichtigtes Wiedereinschalten.

- Die Montage erfolgt über DIN-Hutschienenmontage.
- Die Einbaulage der Geräte ist beliebig.
- Schliessen Sie nun das Gerät gemäss Anschlussschema an.

## Elektrische Anschlüsse



Achtung: Lebensgefahr! Sicherstellen, dass beim Anschluss alle Leitungen spannungsfrei sind!



Es ist zu beachten, dass die auf dem Typenschild angegebenen Daten eingehalten werden!  
Es sind die landesüblichen Vorschriften bei der Installation und Auswahl des Materials der elektrischen Leitungen zu befolgen!

## Technische Daten

	SIRAX MT7100	SIRAX MT7150
<b>Eingang</b>		
Stromsensoren	Rogowski Spulen; Stromwandler sekundär 1A/5A; Spannungswandler 0 ... 333 mV	
Verfügbare Messgrössen	$I_{rms}$ , $U_{rms}$ , $I_{pk}$ , $U_{pk}$ pro Phase; Wirkleistung: $P, P_1, P_2, P_3$ ; Blindleistung: $Q, Q_1, Q_2, Q_3$ ; Scheinleistung: $S, S_1, S_2, S_3$ ; Frequenz; Leistungsfaktor Total und pro Phase; Energie (kWh) Total und pro Phase; bidirektionale Energie (kWh) Total und positiv/negativ pro Phase; Wirk- und Blindenergie (kVAh) Total und pro Phase; $\cos\phi$ ; Crest Faktor Total und pro Phase $\tan\phi$ pro Phase und Mittelwert; Leistungsfaktor Total, pro Phase und Mittelwert; Verzerrter Leistungsfaktor pro Phase und Mittelwert; Leistungsmessung min/max Total, pro Phase und Mittelwert; Überwachung der Phasenfolge; max Bedarf über 15 min. Total und pro Phase; Zeit bei der der max Bedarf entsteht (pro Monat) Total und pro Phase; Zeit über einer Schwelle Total und pro Phase; K Faktor; THD; TDD; harmonische Analyse bis zur 63.; interharmonische Analyse bis zur 63.; SAG; SWELL; Spannungsunterbrechung;	
Hilfsenergie	10 ... 30 VDC oder 19 ... 28 VAC (50/60 Hz)	
Arbeitsfrequenz	1 ... 70 Hz	
Verbrauch	< 0.7 W	
<b>Spannungseingang</b>		
Nennspannung $U_n$	300 $V_{LN}$ / 500 $V_{LL}$	
Impedanz	400 k $\Omega$	
Kontinuierliche Überlast $U_{max}$	400 $V_{LN}$ / 700 $V_{LL}$	

Überlast für 500 ms	600 $V_{LN}$ / 1000 $V_{LL}$
<b>Stromeingang</b>	
Typ	nicht isoliert (externe CTs notwendig)
<b>Stromausgang CT's</b>	
Nennstrom $I_n$	5 AAC
Impedanz	< 0.5 VA pro Phase
Kontinuierliche Überlast $I_{max}$	6 AAC
Überlast für 500 ms	40 AAC
Crest Faktor	< 4 (20 $A_{pk}$ max.)
<b>Spannungsausgang CT's</b>	
Nennspannung	333 mVAC
Impedanz	220 k $\Omega$
Kontinuierliche Überlast $U_{max}$	2.1 $V_{pk}$
Überlast für 500 ms	13 $V_{pk}$
Crest Faktor	< 3 (1 $V_{pk}$ max.)
<b>Ausgang</b>	
Digital	RS485 (Modbus RTU)
Analog	0...10 V oder 4...20 mA (konfigurierbar)
Relais	Freier Kontakt (Alarm) < 100 mA, < 40 VDC (Optomos Kontakt)
<b>Genauigkeit</b>	
Spannung ( $U_n$ : 230/400V)	$\pm 0.5\%$ RDG (10 ... 100% $U_n$ )
Strom ( $I_n$ : 5A)	$\pm 0.5\%$ RDG (5 ... 100% $I_n$ )
Frequenz	$\pm 0.1$ Hz (40 ... 70 Hz)
Wirk- und Blindleistung	$\pm 0.5\%$ RDG
Wirkenergie	Klasse C nach EN50470-1/3 oder Klasse 0.5S nach EN62053-22
Blindenergie	Klasse 0.5S nach EN62053-24
Leistungsfaktor	$\pm (0.001 + 1\% (1.00-PF))$
Temperaturkoeffizient	< 100 ppm/ $^{\circ}$ C
Abtastrate	6400 Hz @ 50 Hz oder 7280 Hz @ 60 Hz
Bandbreite	> 2 kHz
Dämpfung	< 500 mW @ 24 VDC
<b>Sicherheit und Umgebungsbedingungen</b>	
Umgebungstemperatur	-10 ... +60 $^{\circ}$ C
Lagertemperatur	-40 ... +85 $^{\circ}$ C
Relative Feuchte	10 ... 90 % (ohne Betauung)
Einsatzhöhe	max. 2000 m
Überspannungskategorie	CATIII
Isolation	4 kV <sub>RMS</sub> zwischen Netzteil und Messeingängen 4 kV <sub>RMS</sub> zwischen RS485 und Messeingängen 1.5 kV <sub>RMS</sub> zwischen Netzteil und RS485
Gehäuseschutzart IP	IP20
<b>Mechanische Eigenschaften</b>	
Gehäusematerial	PTB
Brennbarkeitsklasse	UL94 V-0, selbstverlöschend, nicht tropfend, halogenfrei
Gewicht	ca. 60 g
DIP Switch	2 Pol
Dimensionen	93 x 17.7 x 68.3 mm (ohne Klemmen)
<b>Anschlüsse</b>	
Anschlüsse	Steckklemmen 3.5 mm, 1 x 2 Pol, 1 x 3 Pol, 1 x 6 Pol Steckklemmen 5.08 mm, 1 x 4 Pol
Anschlussquerschnitt	1.5 mm <sup>2</sup>
Anzugsdrehmoment	max. 0.25 Nm
<b>Normen</b>	
Eingehaltene Normen	EN61000-6-2; EN61000-6-4; EN61000-4-2; EN61000-4-3; EN61000-4-4; EN61000-4-5; EN61000-4-6; EN61010-1; EN61010-2-30

## DIP Switch Einstellungen MT7100 / MT7150

Beschreibung	1	2
Alle Einstellungen vom EEPROM	0	X
Setze Adresse 1 - Baudrate 9600	1	0
Setze Adresse 1 - Baudrate 38400	1	1

## Konfiguration via Software

Der SIRAX MT7100 und MT7150 lassen sich über die kostenlose, auf unser Homepage downloadbare Programmiersoftware konfigurieren. Die genauen Angaben entnehmen Sie aus den entsprechenden Betriebsanleitungen der Produkte.

# Three phase meter SIRAX MT7100 / MT7150

## Safety instructions



The unobjectionable and hazard-free operation presupposes that the safety instructions as well as Device Manual, electronically downloadable via [www.camillebauer.com](http://www.camillebauer.com), have been read and understood.

Please refer to our operating instructions for details. Downloadable from our website [www.camillebauer.com](http://www.camillebauer.com)

The installation and commissioning should only be carried out by trained personnel.

Check the following points before commissioning:

- that the connection wires are not damaged, and that they are not live during wiring
- that the power flow direction and the phase rotation are correct

The instrument must be taken out of service if safe operation is no longer possible (e.g. visible damage). In this case, all the connections must be switched off. The instrument must be returned to the factory or to an authorized service dealer.

It is forbidden to open the housing and to make modifications to the instrument. The instrument is not equipped with an integrated circuit breaker. During installation check that a labeled switch is installed and that it can easily be reached by the operators.

The device is maintenance free. Unauthorized repair or alteration of the unit invalidates the warranty.

## Application area

The SIRAX MT7100 and MT7150 are all-in-one three phase meter with integrated energy meter and universal current input. They are designed for DIN rail mounting installation and can be connected to common current and voltage transformers and Rogowski coils. The devices measure RMS AC and DC, average min. and max. values, frequency, crest factor, harmonic up to the 63rd, THD,  $I_{peak}$  and  $U_{peak}$  and many more. They are equipped with a serial output RS485 Modbus RTU for measurements and a digital output for alarms. The free configuration software makes it very easy to configure the devices.

## Mounting and installation



Ensure a safe working environment during assembly, installation and maintenance work. Disconnect the power supply of the primary conductor and secure it against unintentional reconnection.

- Mounting is done by DIN rail mounting.
- The installation of the devices is arbitrary.
- Now connect the device according to the wiring diagram.

## Electrical connections



Attention: Danger to life! Ensure that all leads are free of potential when connecting them!



Please observe that the data on the type plate must be adhered to! The national provisions have to be observed in the installation and material selection of electric lines!

## Technical data

	SIRAX MT7100	SIRAX MT7150
<b>Input</b>		
Current and voltage probes supported	Rogowski probe; Current transformer secondary 1A / 5A; Voltage transformer 0...333 mV	
Available measurement	$I_{rms}, U_{rms}, I_{pk}, U_{pk}$ per phase; Active power: $P, P_1, P_2, P_3$ ; Reactive power: $Q, Q_1, Q_2, Q_3$ ; Apparent power: $S, S_1, S_2, S_3$ ; Frequency; Power factor total and per phase; Energy (kWh) total and per phase; bidirectional Energy (kWh) total and positive/negative per phase; Active and reactive energy (kVAh) total and per phase; $\cos\phi$ ; Crest factor total and per phase $Tan\phi$ per phase and average; Power factor total, per phase and average; Power factor distortion per phase and average; power measurement min/max total, per phase and average; monitoring phase sequence; max demand over 15 min. total and per phase; time at which arises max demand (per month) total and per phase; time above a threshold total and per phase; K factor; THD; TDD; harmonics analysis up to 63 <sup>th</sup> ; interharmonics analysis up to 63 <sup>th</sup> ; SAG; SWELL; Voltage interruption	
Power supply	10 ... 30 VDC oder 19 ... 28 VAC (50/60 Hz)	
Working frequency	1 ... 70 Hz	
Absorption	max. 2.5 VA	
<b>Voltage input</b>		
Nominal voltage $U_n$	300 $V_{LN}$ / 500 $V_{LL}$	
Impedance	400 k $\Omega$	
Continuous overload $U_{max}$	400 $V_{LN}$ / 700 $V_{LL}$	

Overload for 500 ms	600 $V_{LN}$ / 1000 $V_{LL}$
<b>Current input</b>	
Type	not isolated (external CTs necessary)
<b>Current output CT's</b>	
Nominal current $I_n$	5 AAC
Impedance	< 0.5 VA per phase
Continuous overload $I_{max}$	6 AAC
Overload for 500 ms	40 AAC
Crest factor	< 4 (20 $A_{PK}$ max.)
<b>Voltage output CT's</b>	
Nominal voltage $U_n$	333 mVAC
Impedance	220 k $\Omega$
Continuous overload $U_{max}$	2.1 $V_{PK}$
Overload for 500 ms	13 $V_{PK}$
Crest factor	< 3 (1 $V_{PK}$ max.)
<b>Output</b>	
Digital	RS485 (Modbus RTU)
Analog	0...10 V oder 4...20 mA (configurable)
Relay	Free contact (alarm) <100 mA, <40 VDC (Optomos contact)
<b>Accuracy</b>	
Voltage ( $U_n$ ; 230/400V)	$\pm 0.5\%$ RDG (10 ... 100% $U_n$ )
Current ( $I_n$ ; 5A)	$\pm 0.5\%$ RDG (5 ... 100% $I_n$ )
Frequency	$\pm 0.1$ Hz (40 ... 70 Hz)
Active and reactive power	$\pm 0.5\%$ RDG
Active energy	Class C according to EN50470-1/3 or Class 0.5S according to EN62053-22
Reactive energy	Class 0.5S according to EN62053-24
Power factor	$\pm (0.001 + 1\%(1.00-PF))$
Temperature coefficient	< 100 ppm/ $^{\circ}$ C
Sampling rate	6400 Hz @ 50 Hz or 7280 Hz @ 60 Hz
Bandwidth	> 2 kHz
Absorption	< 500 mW @ 24 VDC
<b>Safety and environmental conditions</b>	
Working temperature	-10 ... +60 $^{\circ}$ C
Storage temperature	-40 ... +85 $^{\circ}$ C
Humidity	10 ... 90 % (not condensing)
Altitude	max 2000 m
Overvoltage category	CATIII
Isolation	4 kV <sub>RMS</sub> between power supply and measuring inputs 4 kV <sub>RMS</sub> between RS485 and measuring inputs 1.5 kV <sub>RMS</sub> between power supply and RS485
Protection class	IP20
<b>Mechanical properties</b>	
Housing material	PTB
Flammability	UL94 V-0, self-extinguishing, non-dripping, halogen-free
Weight	approx 60 g
DIP switch	2 Pole
Dimensions	93 x 17.7 x 68.3 mm (without terminals)
<b>Connections</b>	
Connections	Plug-in terminals 3.5 mm, 1 x 2 pole, 1 x 3 pole, 1 x 6 pole Plug-in terminals 5.08 mm, 1 x 4 pole
Cross-sectional area	1.5 mm <sup>2</sup>
Torque	max 0.25 Nm
<b>Standards</b>	
Adhered standards	EN61000-6-2 ; EN61000-6-4; EN61000-4-2; EN61000-4-3; EN61000-4-4; EN61000-4-5; EN61000-4-6; EN61010-1; EN61010-2-30

## DIP switch settings MT7100 / MT7150

Description	1	2
All settings from EEPROM	0	X
Set Address 1 - Baud 9600	1	0
Set Address 1 - Baud 38400	1	1

## Configuration via software

The SIRAX MT7100 and MT7150 can be configured via the free programming software. This is downloadable on our homepage. The programming instructions can be found in the corresponding operating manuals for the products.

# Mètre triphasé SIRAX MT7100 / MT7150

## Instructions de sécurité



Un fonctionnement parfait et sans danger présuppose que les instructions de sécurité ainsi que le manuel de l'appareil (à télécharger via [www.camillebauer.com](http://www.camillebauer.com)) ont été lus et assimilés.

L'installation et la mise en service doivent impérativement être réalisées par du personnel dûment formé.

Avant la mise en service, vérifiez les points suivants:

- les câbles de raccordement ne doivent pas être endommagés et doivent être sans tension au moment du câblage
- l'amenée de l'énergie et l'ordre des phases doivent être corrects
- il convient de noter que l'appareil ne possède pas de fusible intégré

L'appareil doit être mis hors service si un fonctionnement sans danger n'est plus possible (suite à un dommage visible, par ex.). Il faut alors débrancher tous les raccordements. L'appareil doit être retourné en usine ou à un centre de service technique agréé par notre société.

L'ouverture du boîtier ou toute autre intervention dans l'appareil sont interdites. L'appareil lui-même ne possède pas d'interrupteur principal. Il faut veiller à ce qu'un interrupteur caractérisé en tant que tel dans l'installation soit disponible lors du montage et qu'il soit facilement accessible à l'utilisateur.

L'appareil est sans entretien. Toute intervention dans l'appareil entraîne l'annulation de la garantie!

## Application de l'appareil

Les SIRAX MT7100 et MT7150 sont des alimentations triphasées «Tout-en-un» avec compteur d'énergie intégré et entrée d'alimentation universelle. Ils sont conçus pour un montage sur rail DIN et peuvent être connectés aux transformateurs de courant et de tension communs et aux bobines de Rogowski. Les appareils mesure RMS AC et DC, moyenne min. et max. valeurs, fréquence, facteur de crête, harmonique jusqu'au 63ème, THD,  $I_{peak}$  et  $U_{peak}$  et beaucoup d'autres. Ils sont équipés d'une sortie série RS485 Modbus RTU pour les lectures et d'une sortie numérique pour les alarmes. Le logiciel de configuration libre facilite la programmation des appareils.

## Montage et démontage



Assurer un environnement de travail sûr pendant l'installation, l'installation et la maintenance. Débranchez l'alimentation électrique du conducteur primaire et protégez-le contre un redémarrage involontaire.

- Le montage est effectué par un montage sur rail DIN.
- La position d'utilisation est quelconque.
- Maintenant, connectez l'appareil conformément au schéma de câblage.

## Connexions électriques



Attention: Danger de mort! S'assurer que les conducteurs sont libres de potentiel avant de les connecter!



Il faut veiller à respecter les valeurs indiquées sur la plaque signalétique. Il faut observer les prescriptions spécifiques au pays lors de l'installation et du choix du matériel des lignes électriques.

## Caractéristiques techniques

	SIRAX MT7100	SIRAX MT7150
<b>Entrées</b>		
Capteurs de courant	Bobines de Rogowski; Transformateur de courant secondaire 1A/5A; Transformateur de tension 0...333 mV	
Mesurands disponibles	$I_{RMS}$ ; $U_{RMS}$ ; $I_{PK}$ ; $U_{PK}$ par phase; Puissance active: $P$ , $P_1$ , $P_2$ , $P_3$ ; Puissance réactive: $Q$ , $Q_1$ , $Q_2$ , $Q_3$ ; Puissance apparente: $S$ , $S_1$ , $S_2$ , $S_3$ ; fréquence; Facteur de puissance total et par phase; Énergie (kWh) Total et par phase; énergie bidirectionnelle (kWh) Total et positif / négatif par phase; Énergie effective et réactive (kVARh) Total et par phase; $\cos\phi$ ; Crest Factor Total et par phase Temps par phase et moyenne; Facteur de puissance total, par phase et moyenne; Facteur de puissance déformé par phase et moyenne; Mesure de puissance min / max total, par phase et moyenne; Surveiller la séquence de phase; demande maximale de plus de 15 min. Total et par phase Heure à laquelle la demande maximale est exprimée (par mois) Total et par phase; Temps au-dessus d'un seuil Total et par phase; Facteur K, THD; TDD; analyse harmonique jusqu'au 63ème; analyse interharmonique jusqu'au 63ème; SAG; HOULE; Coupure de courant	
Alimentation auxiliaire	10 ... 30 VDC oder 19 ... 28 VAC (50/60 Hz)	
Fréquence de fonctionnement	1 ... 70 Hz	
Consommation	max 2.5 VA	
<b>Entrée de tension</b>		
Tension nominale $U_n$	300 $V_{LN}$ / 500 $V_{LL}$	

Impédance	400 kΩ
Surcharge continue $U_{max}$	400 $V_{LN}$ / 700 $V_{LL}$
Surcharge pendant 500 ms	600 $V_{LN}$ / 1000 $V_{LL}$
<b>Entrée de courant</b>	
Type	non isolé (CT externes nécessaires)
<b>Sortie de courant CT</b>	
Courant nominale $I_n$	5 AAC
Impédance	< 0.5 VA par phase
Surcharge continue $I_{max}$	6 AAC
Surcharge pendant 500 ms	40 AAC
Facteur de crête	< 4 (20 $A_{PK}$ max.)
<b>Tension de sortie CT</b>	
Tension nominale $U_n$	333 mVAC
Impédance	220 kΩ
Surcharge continue $U_{max}$	2.1 $V_{PK}$
Surcharge pendant 500 ms	13 $V_{PK}$
Facteur de crête	< 3 (1 $V_{PK}$ max.)
<b>Sorties</b>	
Digital	RS485 (Modbus RTU)
Analogue	0...10 V ou 4...20 mA (configurable)
Relais	Contact libre (alarme) <100 mA, <40 VDC (contact Optomos)
<b>Précision</b>	
Tension ( $U_n$ : 230/400V)	± 0.5% RDG (10 ... 100% $U_n$ )
Courant ( $I_n$ : 5A)	± 0.5% RDG (5 ... 100% $I_n$ )
Fréquence	± 0.1 Hz (40 ... 70 Hz)
Puissance active et réactive	± 0.5% RDG
L'énergie active	Classe C selon EN50470-1 / 3 ou Classe 0.5S selon EN62053-22
L'énergie réactive	Classe 0.5S selon EN62053-24
Facteur de puissance	± (0.001 + 1% (1.00-PF))
Coefficient de température	< 100 ppm/°C
fréquence d'échantillonnage	6400 Hz @ 50 Hz ou 7280 Hz @ 60 Hz
Largeur de bande	> 2 kHz
Amortissement	< 500 mW @ 24 VDC
<b>Sécurité et conditions environnementales</b>	
Température de service	-10 ... +60 °C
Température de stockage	-40 ... +85 °C
Humidité relative	10 ... 90 % (sans condensation)
Altitude de service	max 2000 m
Catégorie surtension	CATIII
Isolation	4 kV <sub>RMS</sub> entre l'alimentation et les entrées de mesure 4 kV <sub>RMS</sub> entre RS485 et les entrées de mesure 1,5 kV <sub>RMS</sub> entre l'alimentation et RS485
Degré de protection	IP20
<b>Propriétés mécaniques</b>	
Matériau du boîtier	PTB
Inflammabilité	UL94 V-0, auto-extinguible, non-gouttes, sans halogène
Poids	ca 60 g
DIP-switch	2 pol
Dimensions	93 x 17.7 x 68.3 mm (sans borne)
<b>Bornes</b>	
Bornes	Borne enfichabl 3.5 mm, 1 x 2 pol, 1 x 3 pol, 1 x 6 pol Borne enfichabl 5.08 mm, 1 x 4 pol
Connexion de borne	1.5 mm <sup>2</sup>
Torque	max 0.25 Nm
<b>Normes</b>	
Normes admises	EN61000-6-2; EN61000-6-4; EN61000-4-2; EN61000-4-3; EN61000-4-4; EN61000-4-5; EN61000-4-6; EN61010-1; EN61010-2-30

## Paramètres DIP-switch MT7100 / MT7150

Description	1	2
Tous les paramètres de l'EEPROM	0	X
Définir l'adresse 1 - débit en bauds 9600	1	0
Définir l'adresse 1 - débit en bauds 38400	1	1

## Configuration par logiciel

Les SIRAX MT7100 et MT7150 peuvent être configurés via le logiciel de programmation gratuit qui peut être téléchargé depuis notre page d'accueil. Les détails exacts peuvent être trouvés dans

# Misuratore trifase SIRAX MT7000 / MT7050

Indicazioni per la sicurezza



La lettura e la comprensione delle presenti istruzioni di sicurezza e del manuale di istruzioni, scaricabile in formato elettronico dal sito [www.camillebauer.com](http://www.camillebauer.com), costituiscono il presupposto per il funzionamento corretto e sicuro dell'apparecchio.

Questi apparecchi devono essere installati unicamente da personale qualificato. Prima della messa in servizio assicurarsi che

- i cavi di collegamento siano in condizioni perfette e fuori tensione durante il cablaggio
- la direzione dell'energia e la sequenza delle fasi siano corrette
- prestare attenzione, poichè lo strumento non ha alcun fusibile installato

L'apparecchio deve essere messo fuori servizio quando il funzionamento sicuro non è più garantito (p. es. in caso di danni visibili). Staccare in questo caso tutti i collegamenti e spedire l'apparecchio al nostro stabilimento oppure a un centro di assistenza da noi autorizzato.

È vietato aprire la custodia o intervenire in altro modo sull'apparecchio. L'apparecchio è sprovvisto di interruttore di alimentazione. In fase di installazione, assicurarsi che l'impianto sia dotato di un interruttore contrassegnato, facilmente raggiungibile dall'operatore.

L'apparecchio non ha bisogno di manutenzione. In caso di apertura della custodia dello strumento la garanzia decade automaticamente!

## Applicazione

SIRAX MT7100 e MT7150 sono alimentatori trifase «All in One» con contatore di energia integrato e ingresso di alimentazione universale. Sono progettati per il montaggio su guida DIN e possono essere collegati a comuni trasformatori di corrente e tensione e bobine Rogowski. I dispositivi misura RMS AC e DC, mediamente min. e max. valori, frequenza, fattore di cresta, armonica a 63, THD, Ipeak e Upeak e molti altri. Sono dotati di un'uscita seriale RS485 Modbus RTU per le misure e un'uscita digitale per gli allarmi. Il software di configurazione gratuito semplifica la programmazione dei dispositivi.

## Montaggio e smontaggio



Garantire un ambiente di lavoro sicuro durante l'installazione, l'installazione e la manutenzione. Disconnettere l'alimentazione del conduttore primario e fissarlo contro il riavvio involontario.

- Il montaggio avviene tramite il montaggio su guida DIN.
- La posizione di montaggio dei dispositivi è arbitraria.
- Ora collegare il dispositivo secondo lo schema elettrico.

## Connessioni elettriche



Attenzione: Pericolo di morte! Assicurarsi che l'apparecchio non sia in tensione quando si effettuano i collegamenti elettrici!



Ed inoltre si deve rispettare che siano rispettati i dati riportati sulla targhetta identifi cativa!  
Inoltre devono essere rispettate tutte le prescrizioni nazionali per l'installazione e la posa di cavi ed apparecchiature elettriche!

## Dati tecnici

	SIRAX MT7100	SIRAX MT7150
<b>Input</b>		
Sensori di corrente	Bobine di Rogowski; Trasformatore di corrente secondario 1A / 5A; Trasformatore di tensione 0 ... 333 mV	
Misurazioni disponibili	$I_{rms}$ ; $U_{rms}$ ; $I_{pk}$ ; $U_{pk}$ per fase; Potenza attiva: $P$ , $P_1$ , $P_2$ , $P_3$ ; Potenza reattiva: $Q$ , $Q_1$ , $Q_2$ , $Q_3$ ; Potenza apparente: $S$ , $S_1$ , $S_2$ , $S_3$ ; frequenza; Fattore di potenza totale e per fase; Energia (kWh) Totale e per fase; energia bidirezionale (kWh) Totale e positivo / negativo per fase; Energia efficace e reattiva (kVARh) Totale e per fase; $\cos\phi$ ; Fattore di cresta Totale e per fase $\tan\phi$ per fase e media; Fattore di potenza totale, per fase e media; Fattore di potenza distorto per fase e media; Misura della potenza min / max totale, per fase e media; Monitoraggio della sequenza delle fasi; richiesta massima oltre 15 minuti. Totale e per fase; Momento in cui sorge la domanda massima (al mese) Totale e per fase; Tempo al di sopra di una soglia Totale e per fase; Fattore K; THD; TDD; analisi armonica fino alla 63a; analisi interarmonica fino al 63°; SAG; SWELL; Interruzione di corrente	
Alimentazione	10 ... 30 VDC oder 19 ... 28 VAC (50/60 Hz)	
Frequenza operativa	1 ... 70 Hz	
Assorbimento	max 2.5 VA	
<b>Ingresso tensione</b>		
Tensione nominale $U_n$	300 $V_{LN}$ / 500 $V_{LL}$	
Impedenza	400 kΩ	
Sovraccarico continuo $U_{max}$	400 $V_{LN}$ / 700 $V_{LL}$	

Sovraccarico per 500 ms	600 $V_{LN}$ / 1000 $V_{LL}$
<b>Ingresso corrente</b>	
Tipo	Non isolato (necessario CT esterno)
<b>Uscita corrente CT</b>	
Tensione nominale $I_n$	5 AAC
Impedenza	< 0.5 VA per fase
Sovraccarico continuo $I_{max}$	6 AAC
Sovraccarico per 500 ms	40 AAC
Fattore di cresta	< 4 (20 $A_{PK,max}$ )
<b>Tensione di uscita CT</b>	
Tensione nominale $U_n$	333 mVAC
Impedenza	220 kΩ
Sovraccarico continuo $U_{max}$	2.1 $V_{PK}$
Sovraccarico per 500 ms	13 $V_{PK}$
Fattore di cresta	< 3 (1 $V_{PK,max}$ )
<b>Uscita</b>	
Digitale	RS485 (Modbus RTU)
Analogo	0 ... 10 V o 4 ... 20 mA (configurabile)
Relé	Contatto libero (allarme) <100 mA, <40 VDC (contatto Optomos)
<b>Accuratezza</b>	
Voltage ( $U_n$ : 230 / 400V)	± 0.5% RDG (10 ... 100% $U_n$ )
Corrente ( $I_n$ : 5A)	± 0.5% RDG (5 ... 100% $I_n$ )
Frequenza	± 0.1 Hz (40 ... 70 Hz)
Potenza attiva e reattiva	± 0.5% RDG
Energia attiva	Classe C secondo EN50470-1 / 3 o Classe 0.5S secondo EN62053-22
Energia reattiva	Classe 0.5S secondo EN62053-24
Fattore di potenza	± (0.001 +1%(1.00-PF))
Coefficiente temperatura	< 100 ppm/°C
Abtastrate	6400 Hz @ 50 Hz i 7280 Hz @ 60 Hz
Bandbreite	> 2 kHz
Smorzamento	< 500 mW @ 24 VDC
<b>Sicurezza i Condizioni ambientali</b>	
Temperatura di lavoro	-10 ... +60 °C
Temperatura di stoccaggio	-40 ... +85 °C
Umidità	10 ... 90 % (non condensante)
Altitudine	max 2000 m
Categoria di sovratensione	CATIII
Isolamento	4 kVRMS tra alimentazione e ingressi di misura 4 kVRMS tra RS485 e ingressi di misura 1,5 kVRMS tra alimentazione e RS485
Grado di protezione	IP20
<b>Proprietà meccaniche</b>	
Alloggio materiale	PTB
Infiammabilità	UL94 V-0, autoestinguente, non gocciolante, privo di alogeni
Peso	aprox 60 g
DIP switch	2 poli
Dimensioni	93 x 17.7 x 68.3 mm (escluso morsetto)
<b>Connessioni</b>	
Connessioni	Morsetti ad innesto 3.5 mm, 1 x 2 poli, 1 x 3 poli, 1 x 6 poli Morsetti ad innesto 5.08 mm, 1 x 4 poli
Sezione di collegamento	1.5 mm <sup>2</sup>
Momento torcente	max 0.25 Nm
<b>Norma</b>	
Rispettato gli standard	EN61000-6-2; EN61000-6-4; EN61000-4-2; EN61000-4-3; EN61000-4-4; EN61000-4-5; EN61000-4-6; EN61010-1; EN61010-2-30

## Impostazioni dei DIP switch MT7100 / MT7150

Description	1	2
Tutte le config da EEPROM	0	X
Impostare l'indirizzo 1 - velocità di trasmissione 9600	1	0
Impostare l'indirizzo 1 - velocità di trasmissione 38400	1	1

## Configurazione tramite software

SIRAX MT7100 e MT7150 possono essere configurati tramite il software di programmazione gratuito che può essere scaricato dalla nostra homepage. I dettagli esatti possono essere trovati nelle istruzioni operative corrispondenti per i prodotti.

# Medidor trifásico SIRAX MT7000 / MT7050

## Instrucciones de seguridad



Para asegurar el funcionamiento fiable y seguro del dispositivo, es imprescindible familiarizarse adecuadamente con esta hoja de seguridad, así como con el manual de instrucciones, que se puede descargar en nuestro sitio web [www.camillebauer.com](http://www.camillebauer.com).

Este dispositivo únicamente podrá ser manejado por personal familiarizado con el manual de instrucciones. Instrucciones de montaje y puesta en funcionamiento:

- Compruebe todos los cables de conexión por daños. Establezca todas las conexiones antes de conectar la alimentación de red
- Compruebe el sentido del flujo de corriente así como la secuencia de fase
- Compruebe que ese equipo no tiene fusibles internos

El dispositivo se pondrá fuera de servicio cuando no se puede asegurar el funcionamiento seguro y fiable, por ejemplo, si presenta daños visibles. En tal caso, desconecte todos los cables y entregue el dispositivo a un servicio de reparación autorizado.

Quedará estrictamente prohibido abrir la carcasa o efectuar reparaciones en el dispositivo. El dispositivo no ofrece ningún interruptor principal. Procure montar un interruptor en el lado de la instalación que sea fácilmente accesible por parte del personal usuario.

El dispositivo no requiere ningún tipo de mantenimiento. No se podrá presentar ningún tipo de reclamación ante el fabricante por los daños que se desprendan del uso indebido del dispositivo.

## Aplicación

El SIRAX MT7100 y MT7150 son fuentes de alimentación trifásicas «Todo en Uno» con medidor de energía integrado y entrada de energía universal. Están diseñados para montaje en riel DIN y se pueden conectar a transformadores de corriente y voltaje comunes y bobinas Rogowski. Los dispositivos miden RMS AC y DC, promedio min. y max. valores, frecuencia, factor de cresta, armónico a 63, THD, Ipeak y Upeak y muchos más. Están equipados con una salida serial RS485 Modbus RTU para mediciones y una salida digital para alarmas. El software de configuración gratuita hace que sea muy fácil programar los dispositivos.

## Montaje y desmontaje



Asegure un ambiente de trabajo seguro durante la instalación, instalación y mantenimiento. Desconecte la fuente de alimentación del conductor primario y asegúrelo contra un reinicio involuntario.

- El montaje se realiza mediante montaje en carril DIN.
- La posición de montaje de los dispositivos es arbitraria.
- Ahora conecta el dispositivo de acuerdo con el diagrama de cableado.

## Conexión eléctrica



¡Peligro de muerte! Asegúrese de que los conductores estén libres de potencial al establecer la conexión!



Respete los datos indicados en la placa de características. Aplicarán todas las normas y reglamentaciones eléctricas aplicables en el lugar de uso.

## Datos técnicos

	SIRAX MT7100	SIRAX MT7150
<b>Entrada</b>	Bobinas de Rogowski; Transformador de corriente secundario 1A / 5A; Transformador de tensión 0 ... 333 mV	
Sensores de corriente	Bobinas de Rogowski; Transformador de corriente secundario 1A / 5A; Transformador de tensión 0 ... 333 mV	
Mediciones disponibles	$I_{L_{max}}$ ; $U_{L_{max}}$ ; $I_{pk}$ ; $U_{pk}$ por fase; Potencia activa: $P$ , $P_1$ , $P_2$ , $P_3$ ; Potencia reactiva: $Q$ , $Q_1$ , $Q_2$ , $Q_3$ ; Potencia aparente: $S$ , $S_1$ , $S_2$ , $S_3$ ; frecuencia; Factor de potencia total y por fase; Energía (kWh) Total y por fase; energía bidireccional (kWh) Total y positivo / negativo por fase; Energía efectiva y reactiva (kVARh) Total y por fase; $\cos\phi$ ; Factor de Crest Total y por fase Tiempo por fase y media; Factor de potencia total, por fase y media; Factor de potencia distorsionado por fase y media; Medida de potencia mínima / máxima total, por fase y media; Monitoreo de la secuencia de fases; demanda máxima durante 15 min. Total y por fase; Tiempo a partir del cual surge la demanda máxima (por mes) Total y por fase; Tiempo por encima de un umbral Total y por fase; Factor K; THD; TDD; análisis de armónicos hasta el 63%; análisis interarmónico hasta el 63; SAG; hincbe; Interrupción de la alimentación	
Energía auxiliar	10 ... 30 VDC oder 19 ... 28 VAC (50/60 Hz)	
Frecuencia de funcionamiento	1 ... 70 Hz	
Consumo de potencia	max 2.5 VA	
<b>Entrada de tensión</b>		
Tensión nominal $U_n$	300 $V_{LN}$ / 500 $V_{LL}$	

Impedancia	400 k $\Omega$
Sobrecarga continua $U_{max}$	400 $V_{LN}$ / 700 $V_{LL}$
Sobrecarga por 500 ms	600 $V_{LN}$ / 1000 $V_{LL}$
<b>Entrada de corriente</b>	
Tipo	no aislado (CT externos necesarios)
<b>Salida de corriente CT</b>	
Corriente nominal $I_n$	5 AAC
Impedancia	< 0.5 VA por fase
Sobrecarga continua $I_{max}$	6 AAC
Sobrecarga por 500 ms	40 AAC
Factor de Crest	< 4 (20 $A_{PK}$ max.)
<b>Voltaje de salida CT</b>	
Tensión nominal $U_n$	333 mVAC
Impedancia	220 k $\Omega$
Sobrecarga continua $U_{max}$	2.1 $V_{PK}$
Sobrecarga por 500 ms	13 $V_{PK}$
Factor de Crest	< 3 (1 $V_{PK}$ max.)
<b>Salida</b>	
Digital	RS485 (Modbus RTU)
Análogo	0 ... 10 V o 4 ... 20 mA (configurable)
Relé	Optomos contacto max. 50mA, 30VDC
<b>Precisión</b>	
Voltaje ( $U_n$ : 230 / 400V)	$\pm$ 0.5% RDG (10 ... 100% $U_n$ )
Corriente ( $I_n$ : 5A)	$\pm$ 0.5% RDG (5 ... 100% $I_n$ )
Frecuencia	$\pm$ 0.1 Hz (40 ... 70 Hz)
Potencia activa y reactiva	$\pm$ 0.5% RDG
Energía activa	Clase C según EN50470-1 / 3 o Clase 0.5S según EN62053-22
Energía reactiva	Clase 0.5S según EN62053-24
Factor de potencia	$\pm$ (0.001 +1% (1.00-PF))
Coefficiente de temperatura	< 100 ppm/ $^{\circ}$ C
Abtastrate	6400 Hz @ 50 Hz o 7280 Hz a 60 Hz
Bandbreite	> 2 kHz
Factor de crest	4
<b>Seguridad y Condiciones ambientales</b>	
Temperatura ambiente	-10 ... +60 $^{\circ}$ C
Temperatura de almacenamiento	-40 ... +85 $^{\circ}$ C
Humedad relativa	10 ... 90 % (sin condensación)
Altitud	max. 2000 m
Categoría de sobretensión	CATIII
Aislamiento	4 kVRMS entre la fuente de alimentación y las entradas de medición 4 kVRMS entre RS485 y entradas de medición 1.5 kVRMS entre la fuente de alimentación y RS485
Protección de vivienda IP	IP20
<b>Proprietà meccaniche</b>	
Material de la carcasa	PTB
Inflamabilidad	UL94 V-0, autoextinguible, antigoteo, libre de halógenos
Peso	aprox 55 g
DIP switch	2 Pol
Dimensiones	93 x 17.7 x 68.3 mm (sin abrazaderas)
<b>Conexiones</b>	
Conexiones	plug-in terminales 3.5 mm, 2x10 poly
Sección transversal	1.5 mm <sup>2</sup>
Esfuerzo de torsión	max 0.25 Nm
<b>Normas</b>	
Cumplió con los estándares	EN61000-6-3; EN61000-4-2; EN61000-4-3; EN61000-4-4; EN61000-4-5; EN61000-4-6; EN61010-1





## Configuración del DIP switch MT7100 / MT7150

Descripción	1	2
Todas las configuraciones de EEPROM	0	X
Establecer la dirección 1 - velocidad en baudios 9600	1	0
Establecer la dirección 1 - velocidad en baudios 38400	1	1





## Configuración a través de software

El SIRAX MT7100 y MT7150 se pueden configurar a través del software de programación gratuito que se puede descargar desde nuestra página de inicio. Los detalles exactos se pueden encontrar





## Zeichenerklärung

	Geräte dürfen nur fachgerecht entsorgt werden
	CE-Konformitätszeichen.
	Achtung! Allgemeine Gefahrenstelle. Betriebsanleitung beachten.
	Achtung: Lebensgefahr!
	Bitte beachten





## Explication de signe

	Les appareils ne doivent être éliminés que de façon appropriée
	Sigle de conformité CE
	Attention! Point dangereux général. Tenir compte du mode d'emploi.
	Attention: Danger de mort!
	S'il vous plaît noter





## Explicación de signo

	Si procede, elimine el equipo siguiendo las normas y reglamentaciones aplicables del país de que se trate
	Marca de conformidad CE
	¡Atención! Lugar de peligro. Consulte el manual de instrucciones.
	¡Peligro de muerte!
	Atención

## Sign explanation

	Device may only be disposed of in a professional manner
	CE conformity mark
	Caution! General hazard point. Read the operating instructions.
	Attention: Danger to life!
	Please note

## Firma la spiegazione

	Smtire gli apparecchi in conformità alle normative vigenti
	Marchatura CE di conformità
	Attenzione! Pericolo generale. Osservare le istruzioni per l'uso.
	Attenzione: Pericolo di morte!
	Si prega di notare

## Typen- und Namenschilder / Type- and nameplates / Plaques signalétiques / Targhette / Placas de identificación

### SIRAX MT7100

Article-No.: 180034  
20161118105725  
HW: 04 FW: 001 M. ID: 25

### SIRAX MT7150

Article-No.: 180042  
20161118105725  
HW: 04 FW: 001 M. ID: 25

Camille Bauer Metrawatt AG  
Aargauerstrasse 7  
5610 Wohlen / Switzerland

## Dimensionen / Dimensions / Dimensionis/ Dimensioni / Dimensiones SIRAX MT7100 / MT7150

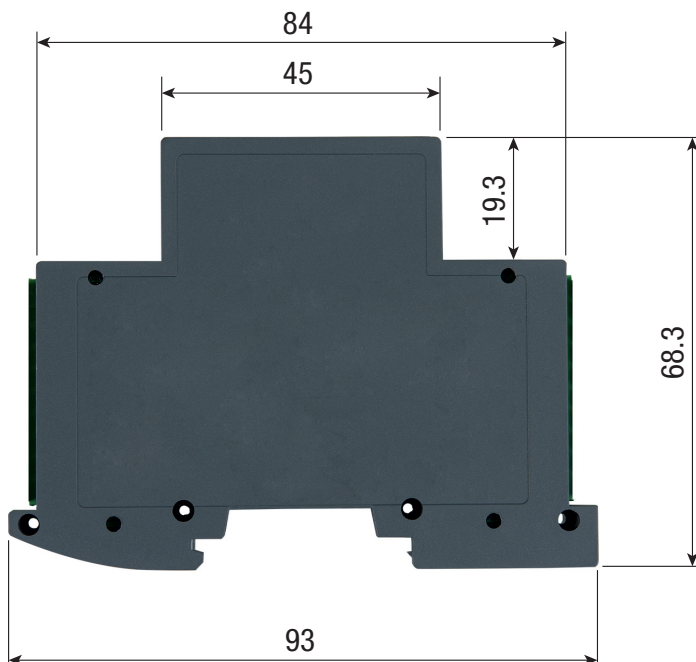

Elektrische Anschlüsse / Electrical connections / Connexions électriques / Conessioni elettriche / Conexión eléctrica

3-Phasen, 4 Draht, 3 Stromwandler /  
3-phase, 4 wires, 3 CT's connection

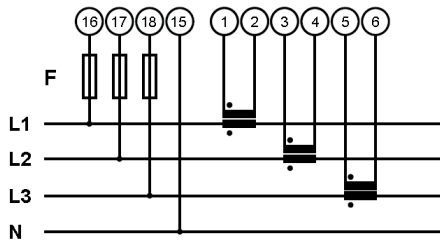

3-Phasen, 4 Draht, 3 Spannungswandler /  
3-phase, 4 wires, 3 CT's and 3 VT's connection

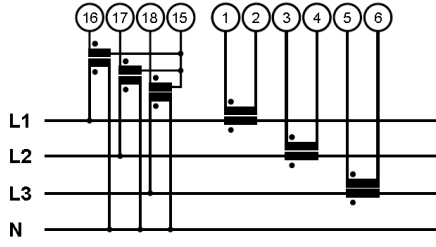

3-Phasen, 3 Draht, 3 Stromwandler /  
3-phase, 3 wires, 3 CT's connection

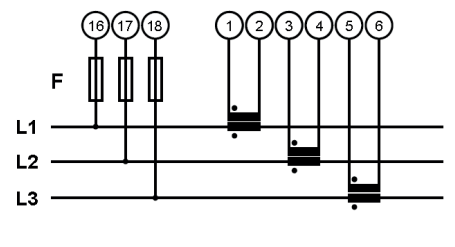

3-Phasen, 3 Draht, 3 Spannungswandler /  
3-phase, 3 wires, 3 CT's and 3 VT's connection

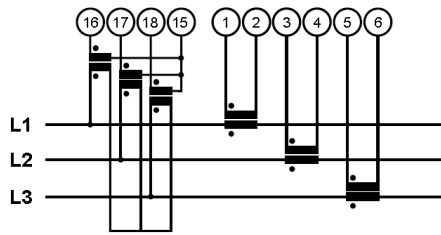

3-Phasen, 3 Draht, 2 Stromwandler (Aron) /  
3-phase, 3 wires, 2 CT's connection (Aron)

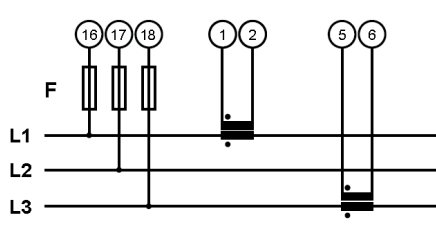

3-Phasen, 3 Draht, 2 Stromwandler/3 Spannungswandler (Aron) /  
3-phase, 3 wires, 2 CT's and 3 VT's connection (Aron)

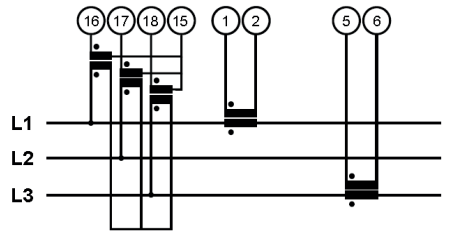

1-Phasen, 2 Draht, Verbindung mit 1 TA /  
1-phase, 2 wires, connection with 1 TA

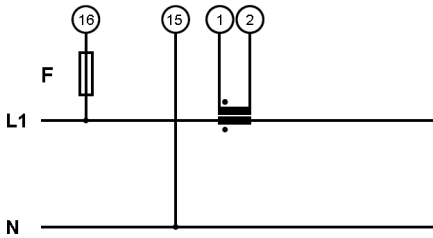

1-Phasen, 2 Draht, Verbindung mit 1 TA und 1 TV /  
1-phase, 2 wires, connection with 1 TA and 1 TV

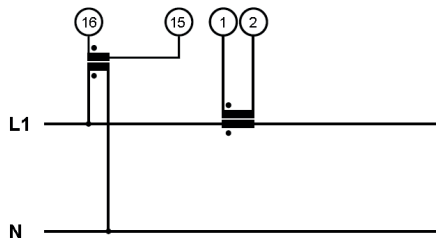

Digitaler Ausgang an Klemme 8-9-10 in digitaler  
Ausgangskonfiguration /  
Digital output on terminal 8-9-10 in digital output  
configuration

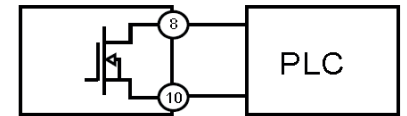

Kommunikation über T-BUS (mit dem entsprechenden  
optionalen Verbinder) /  
Communication via T-Bus (with the power optional  
connector)

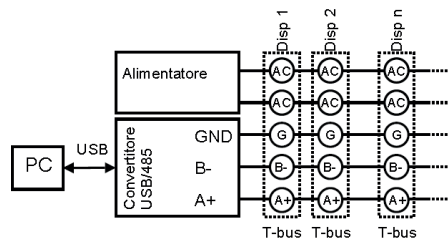

Kommunikation über Klemmen 8-9-10 in  
RS485-Konfiguration /  
Communication via terminal 8-9-10 in RS485 configuration

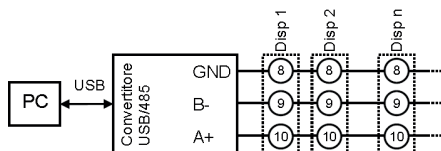

Stromversorgung / Power supply

