

Device handbook / Operating instructions

SIRAX BM1450

Universal, 4-channel DC meter for the determination of voltage, current, power, capacity and energy



 CAMILLE BAUER

Camille Bauer Metrawatt AG
Aargauerstrasse 7
CH-5610 Wohlen/Schweiz

Tel: +41 56 618 21 11
Fax: +41 56 618 21 21

info@cbmag.com
www.camillebauer.com

Legal information

Warning notices

In this document warning notices are used, which you have to observe to ensure personal safety and to prevent damage to property. The explanation of the individual symbols can be found in chapter 2.

Qualified personnel

The product described in this document may be handled by personnel only, which is qualified for the respective task. Qualified personnel have the training and experience to identify risks and potential hazards when working with the product. Qualified personnel are also able to understand and follow the given safety and warning notices.

Intended use

The product described in this document may be used only for the application specified. The maximum electrical supply data and ambient conditions specified in the technical data section must be adhered. For the perfect and safe operation of the device proper transport and storage as well as professional assembly, installation, handling and maintenance are required.

Disclaimer of liability

The content of this document has been reviewed to ensure correctness. Nevertheless it may contain errors or inconsistencies and we cannot guarantee completeness and correctness. This is especially true for different language versions of this document. This document is regularly reviewed and updated. Necessary corrections will be included in subsequent version and are available via our webpage www.camillebauer.com.

Feedback

If you detect errors in this document or if there is necessary information missing, please inform us via e-mail to: customer-support@camillebauer.com

Table of contents

1. Introduction	4
1.1 Purpose of this document	4
1.2 Scope of supply	4
1.3 Further documents	4
2. Safety and warning notes	4
3. Device overview	5
3.1 Brief description	5
3.2 Available measurement data	5
4. Installation and commissioning	5
4.1 Mechanical installation	6
4.1.1 Panel cut out	6
4.1.2 Mounting of the device	6
4.1.3 Demounting of the device	6
4.2 Electrical connections	6
4.2.1 Possible cross sections and tightening torques	7
4.2.2 Inputs	7
4.2.3 Power supply	7
4.2.4 Modbus interface RS485	7
4.3 Commissioning	8
4.3.1 Operating the device	8
4.3.2 LED indications	8
4.3.3 Measurement reading screens	9
4.3.4 Timer screen	10
4.3.5 Number of interruptions	10
4.3.6 On hour	10
4.3.7 Run hour	10
5. Setup screens	12
6. Programming	13
6.1 Password protection	13
6.2 System Parameter selection screen	13
6.2.1 Automatic voltage detection	13

6.2.2 Nominal voltage	14
6.2.3 Channel selection	14
6.2.4 Current Full Scale value	14
6.2.5 Current shunt value	14
6.2.6 Demand intergration time	14
6.2.7 Energy update rate	14
6.2.8 Reverse locking	14
6.2.9 Auto scrolling	14
6.2.10 Noise current	15
6.2.11 Energy output	15
6.2.12 Energy digit reset count	15
6.3 Selection of communication parameter	15
6.3.1 Address setting	15
6.3.2 Baud rate	15
6.3.3 Parity	15
6.4 Reset parameter selection	15
6.5 Ouput parameter selection	15
6.5.1 Select Relay output	15
6.5.1.1 Limit Relay configuration	15
6.5.1.1.1 Limit parameter	15
6.5.1.1.2 Limit configuration	16
6.5.1.1.3 Trip point	16
6.5.1.1.4 Hysteresis	16
6.5.1.1.5 Energizing delay	16
6.5.1.1.6 De-energizing delay	16
6.5.1.2 Pulse Relay configuration	16
6.5.1.2.1 Pulse parameter selection	16
6.5.1.2.2 Pulse divisor	16
6.5.1.2.3 Pulse duration	17
6.5.1.3 Timer	17
6.5.1.3.1 Number of cycles	17
6.5.1.3.2 Timer configuration	17
6.5.1.3.3 On delay	17
6.5.1.3.4 Off delay	17
6.5.1.4 Remote operation	17
6.5.1.5 Reverse locking Relay	17
6.5.1.5.1 Parameter selection	17
6.5.1.5.2 Relay configuration	17
6.5.1.5.3 On delay	17
6.5.1.5.4 Off delay	17
6.6 User assignable screen setup	17
6.6.1 Number of user screens	17
6.7 Factory reset	17
6.7.1 Factory reset confirmation	17
7. Relay output	17
7.1 Limit Relay	17
7.2 Pulse output	18
7.3 Timer output	19
8. Service, maintenance and disposal	19
8.1 Repair work and modifications	19
8.2 Calibration and new adjustment	19
8.3 Cleaning	19
8.4 Disposal	19
8.5 Return	19
9. Technical data	19
9.1 Dimensional drawing	21
9.2 Connection and programming via RS485 (Modbus) interface	21
10. Interface definition Modbus RTU	22
10.1 Modbus function	22
10.2 Data types	23
10.3 User assignable Modbus registers	33

1. Introduction

1.1 Purpose of this document

This document describes the universal, 4-channel DC meter SIRAX BM1450. It is intended to be used by:

- Installation personnel and commissioning engineers
- Service and maintenance personnel
- Planners

Scope

This handbook is valid for all hardware versions of the BM1450. Some of the functions described in this document are available only, if the necessary optional components are included in the device.

Required knowledge

A general knowledge in the field of electrical engineering is required. For assembly and installation of the device knowledge of applicable national safety regulations and installation standard is required.

1.2 Scope of supply







- Measurement device SIRAX BM1450
- Safety instructions (multiple languages)
- Connection set: 4 mounting clamps

1.3 Further documents

The following documents are provided electronically via www.camillebauer.com:

- Safety instructions SIRAX BM1450
- Operating Instructions SIRAX BM1450
- Data sheet SIRAX BM1450
- Flyer SIRAX Monitor Line

2. Safety and Warnings notes

Symbol	Meaning
	Device may only be disposed of in a professional manner!
	Caution! General hazard point. Read the operating instructions. If the warning notice is not followed damage to property or severe personal injury may result.
	Attention: Danger to life! If the warning notice is not followed death or severe personal injury will result.
	Please note If the warning notice is not followed the device may be damaged or may not fulfill the expected functionality.
	CE conformity mark. The device fulfills the requirements of the applicable EC directives. See declaration of conformity.
	Double insulation, device of protection class 2
CAT III CAT II	Measurement category CAT III and CAT II for current / voltage inputs, power supply and relay outputs

3. Device overview

3.1 Brief description

The universal 4-channel DC meter SIRAX BM1450 can be used for monitoring and control in DC systems. These meters measure a variety of electrical parameters such as DC voltage, current, power, energy and electrical charge. They support bidirectional voltage and current measurement, 1-channel voltage input, 4-channel current input and 4 relay outputs. The large 4-line, 8-digit LED display provides easy reading of data directly on the device front. The configuration can be done on site using three pushbuttons or via Modbus RTU.

3.2 Available measurement data

Table 1

Parameter	CH1	CH2	CH3	CH4	Σ	Min	Max	Measuring range	Display range	Accuracy
Voltage		•				•	•	±10...±60 VDC ±61...±200 VDC ±201...±1000 VDC	0...±9999	± 0.5% des Nennwerts
Current	•	•	•	•		•	•	50...150 mV	0...±9999	± 0.5% des Nennwerts
Power (Import & Export)	•	•	•	•	•			0...±1.2 MW / CH 0...±4.0 MW / CH 0...±20 MW / CH	0 ... ±9999	± 0.5% des Nennwerts
Energy (Import & Export)	•	•	•	•	•			0...99999999	0...99999999	Klasse 1
Electric charge (Import & Export) Ampere Hour	•	•	•	•	•			0...99999999	0...99999999	–
Power Demand (Import & Export)	•	•	•	•	•		•	0...±1.2 MW / CH 0...±4.0 MW / CH 0...±20 MW / CH	0...9999	–
Durrent Demand (Import & Export)	•	•	•	•	•		•	50...150 mV	0...9999	–
On Hour		•						999999.59	999999.59	–
Run Hour	•	•	•	•				999999.59	999999.59	–
Number of Interruptions		•						0...9999	0...9999	–

4. Installation and commissioning



The installation and commissioning should only be carried out by trained personnel. Check the following points before commissioning:

- that the limits of the operating temperature are not exceeded: **-10 ... +55° C**
- that the maximum values for all the connections are not exceeded, see „Technical data“ section,
- that the connection wires are not damaged, and that they are not live during wiring,
- the polarity of the DC supply is correct.



The instrument must be taken out of service if safe operation is no longer possible (e.g. visible damage). In this case, all the connections must be switched off. The instrument must be returned to the factory or to an authorized service dealer.

It is forbidden to open the housing and to make modifications to the instrument. The instrument is not equipped with an integrated circuit breaker. During installation check that a labeled switch is installed and that it can easily be reached by the operators.

Unauthorized repair or alteration of the unit invalidates the warranty.

The national provisions have to be observed in the installation and material selection of electric lines!

4.1 Mechanical installation

4.1.1 Panel cut out

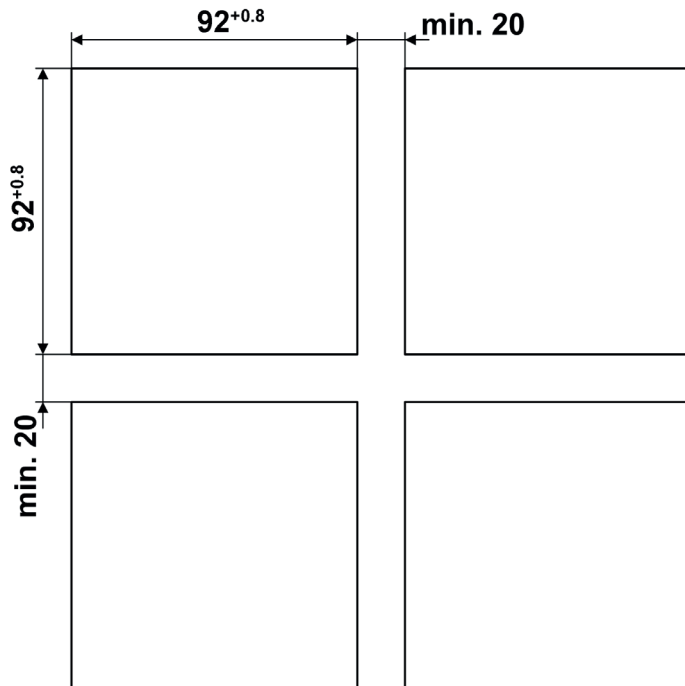

4.1.2 Mounting of the device

The device is suitable for panel widths up to 5mm

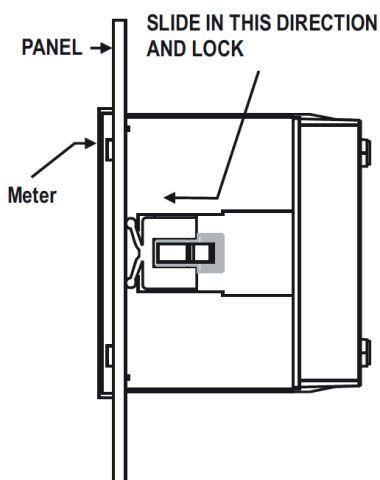

Variant with Mounting clamps

- Slide the device into the cutout from the outside
- Mounting is by four side clamps, slide the side clamps through side slot till side clamp gets firmly locked in a groove (Refer fig.) Consideration should be given to the space required behind the instrument to allow for bends in the connection cables.

4.1.3 Demounting of the device

The demounting of the device may be performed only if all connected wires are out of service. Remove all plug-in terminals and all connections of the current and voltage inputs. Pay attention to the fact, that current transformers must be shortened before removing the current connections to the device. Then demount the device in the opposite order of mounting.

4.2 Electrical connections



Ensure under all circumstances that the leads are free of potential when connecting them!

4.2.1 Possible cross sections and tightening torques

Terminals 1 ... 14

Single wire: $\leq 4,0\text{mm}^2$ or multiwire with end splices: $2 \times 1,5\text{mm}^2$

Torque: $0.5 \dots 0.6\text{Nm}$ resp. $4.42 \dots 5.31 \text{ lbf in}$

Terminal A, B, G

Single wire: $\leq 1,5\text{mm}^2$ or multiwire with end splices: $2 \times 0,75\text{mm}^2$

Torque: max. 0.5 Nm resp. 4.42 lbf in

4.2.2 Inputs



All voltage measurement inputs must originate at circuit breakers or fuses rated by 1 Amps.

For safety reasons, the panel must be properly grounded in accordance with local regulations.

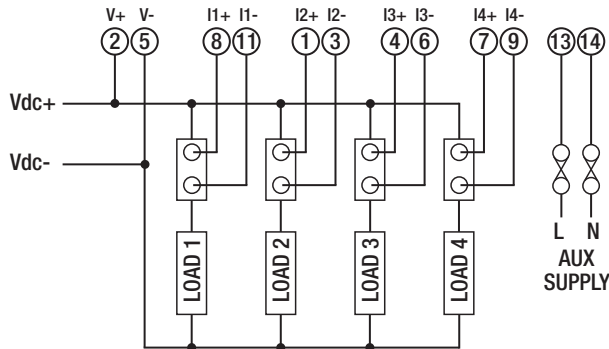

4.2.3 Power supply



A marked and easily accessible current limiting switch has to be arranged in the vicinity of the device for turning off the power supply. Fusing should be 10 Amps or less and must be rated for the available voltage and fault current.

4.2.4 Modbus interface RS485

Via the optional Modbus interface measurement data may be provided for a superior system. However, the Modbus interface cannot be used for device parameterization.

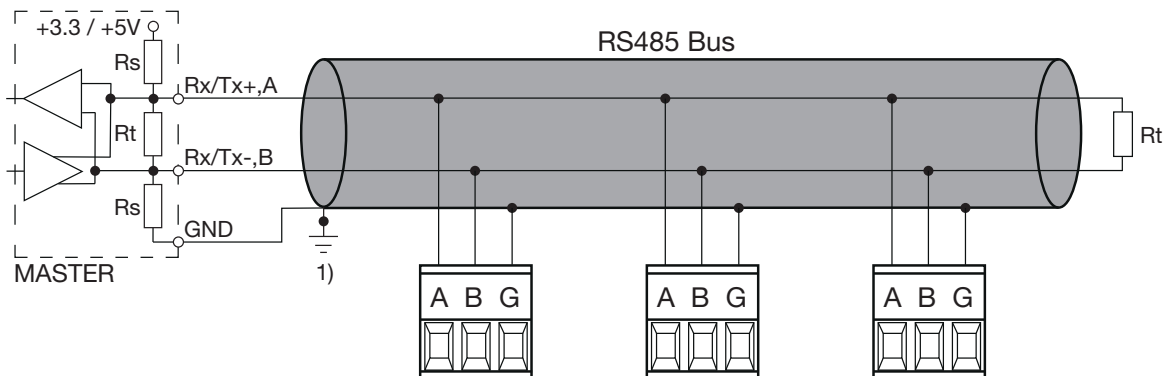

1) One ground connection only. This is possibly made within the master (PC).

Rt: Termination resistors: 120Ω each for long cables ($> \text{approx. } 10 \text{ m}$)

Rs: Bus supply resistors, 390Ω each

The signal wires (A, B) have to be twisted. GND (G) can be connected via a wire or via the cable screen. In disturbed environments shielded cables must be used. Supply resistors (Rs) have to be present in bus master (PC) interface. Stubs should be avoided when connecting the devices. A pure daisy chain network is ideal.

You may connect up to 32 Modbus devices to the bus. A proper operation requires that all devices connected to the bus have equal communication settings (baud rate, transmission format) and unique Modbus addresses.

The bus system is operated half duplex and may be extended to a maximum length of 1200 m without repeater.



4.3 Commissioning



Before commissioning you have to check if the connection data of the device match the data of the plant. If so, you can start to put the device into operation by switching on the power supply and the measurement inputs.



It is to be noted, that the data given on the type plate are respected!

SIRAX BM1450		  	
ORDER CODE: 177065			
SR No.: 16/12/0001	CLASS: 1.0	V3.02	
VOLTAGE INPUT: 1 CH, 10...60VDC			
CURRENT INPUT: 4 CH, 50...150mV			
AUXILIARY: 60...300V AC/DC, 6.0VA			
OPTION: RS485 + 4Relay			

Label version standard

4.3.1 Operating the device



The following values of the SIRAX BM1450 can be configured and programmed on site: voltage input, current input, shunt setting range, number of channels and demand integration time.

There are three buttons on the front panel that allow the user to navigate through the available measured values (instantaneous values, energy, and min./max.) and to configure the device.

Operation is performed by means of 3 keys:

- 3 keys “ UP”, “ DOWN” and “OK” for navigation and for the selection of values.

4.3.2 LED indications

The LED indicators are used for various purposes. They change color according to their status.

In the setup menu

LED	Operating condition
green	Display of the channel to be parameterized

In display mode

LED	Operating condition
green	Normal operation (good condition)
red	Overload condition

In display mode with limit relay

LED	Operating condition
green	Normal operation (good condition)
red	Alarm condition available

In the display mode with derived parameters (power, energy, amp hours)

LED	Operating condition
green	Voltage and current in normal operation (good condition)
red	If one of the parameters is in overload condition
red	For limit assignment in the alarm state
green	With limit assignment normal operation (state good)

When more than one from the above conditions are applicable, the LEDs will follow "OR" logic for alarm condition and "AND" logic for healthy condition, i.e. it will glow red when even one of the alarm conditions is true and it will only glow green when all of the healthy conditions are true.

4.3.3 Measurement Reading Screens

In normal operation the user is presented with one of the measurement reading screens out of several screens. These screens may be scrolled through one at a time in incremental order by pressing the “**UP**” key and in decremental order by pressing “**DOWN**” key.

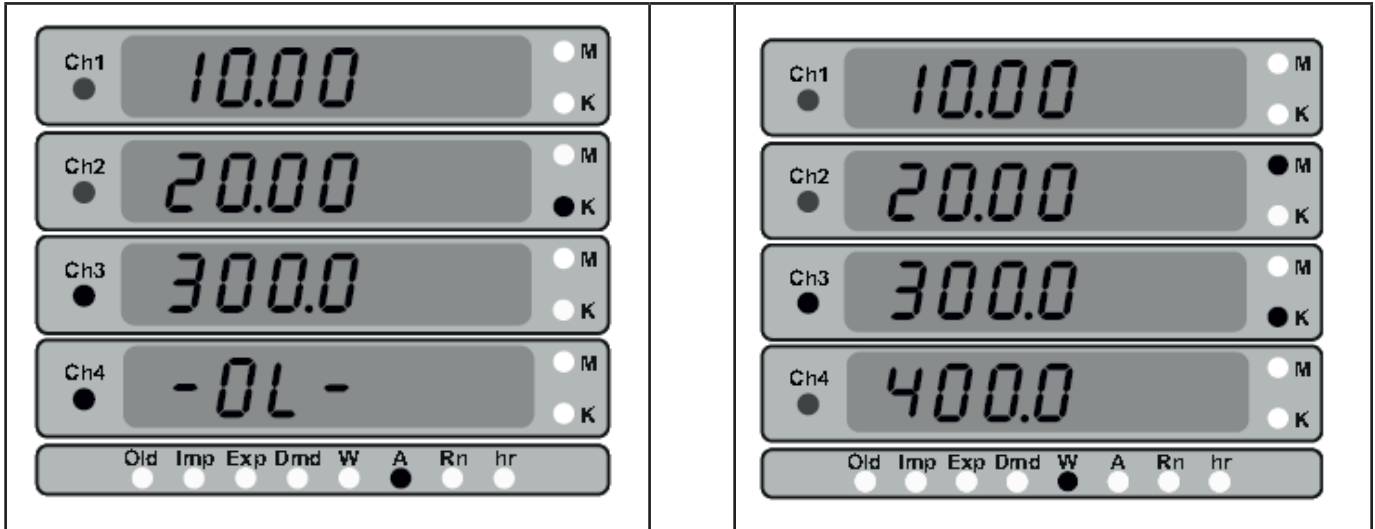

Example of a current display with the following values:
 Channel 1: 10 A
 Channel 2: 20000 A (20×10^3)
 Channel 3: 300 A
 Channel 4: Overload condition

For channels 1 and 2, the LEDs light up green, so these channels are in the normal state (good condition).

For channel 3, the LED lights up red and a measured value is displayed. This means that a limit relay is used on this channel and an alarm state is present.

For channel 4, the LED lights up red and -OL- is displayed on the display. This means that the measured value is above the nominal value on this channel.

Example of a power display with the following values:
 Channel 1: 10 W
 Channel 2: 20000000 W (20×10^6)
 Channel 3: 300000 W (300×10^3)
 Channel 4: Overload condition

For channels 1 and 2, the LEDs light up green, so these channels are in the normal state (good condition).

For channel 3, the LED lights up red and a measured value is displayed. This means that one of the following conditions exists:

1. On this channel there is a limit relay and the alarm state is given
2. Voltage and current values are in overload condition

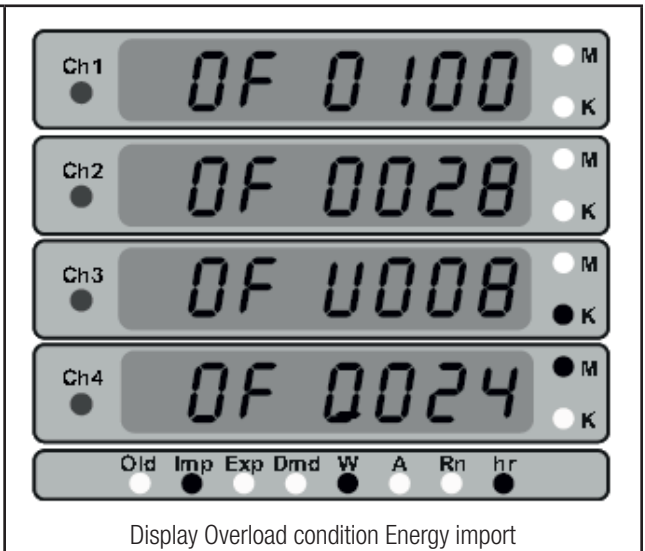
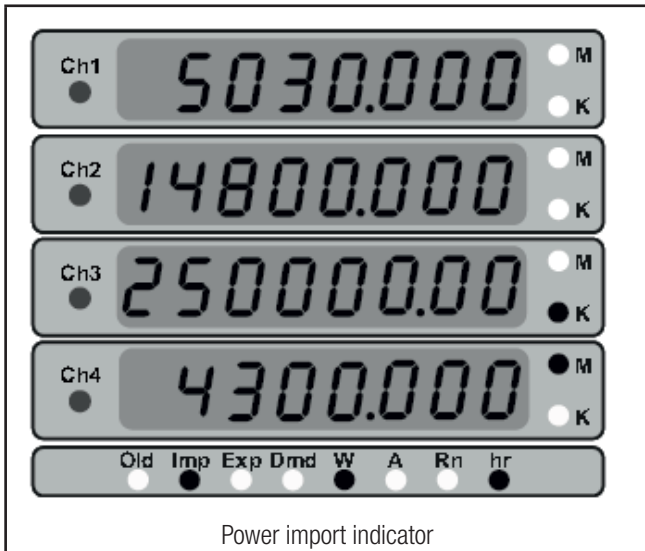

Shown above are the import energy screens. The display of the meter can only accommodate 8 digits. So to display more than 8 digit energy, an overflow screen is added. When the energy reaches the energy digit reset count, it starts the count from 0 again. When this happens the corresponding overflow is increased by 1. The maximum value of the overflow is 2000 for individual channels. Thus the highest energy that the meter can show is 20009999999 Mwh. To obtain the value for current energy reading, the user need to multiply the overflow count by 10 raised to energy digit reset count for the corresponding channel and add the result in displayed energy reading.

- Channel 1: $[(100 \times 10^9) + 5030] = 10000005030 \text{ Wh}$
- Channel 2: $[(28 \times 10^7) + 14800] = 280014800 \text{ Wh}$
- Channel 3: $[(8 \times 10^6) + 250000] = 8250000 \text{ kWh}$
- Channel 4: $[(24 \times 10^6) + 4300] = 2400004300 \text{ MWh}$

4.3.4 Timer screen

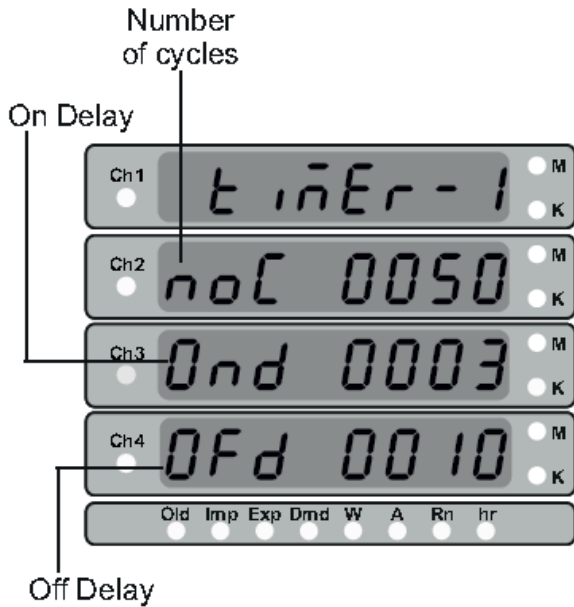

As shown in the picture above, there are upto four timer screens present in measurement screens. They show values of number of cycles, on delay and off delay for corresponding timer. When timer is running, these values are shown in countdown mode. If number of cycles is set as 0, then on this screen number of cycles will always increment from 0 up to 9999.

- Note:
1. Press UP key to start the timer
 2. Press down key to stop the timer

Timer unused: Timer is not selected as a relay output

4.3.5 Number of Interruptions

This screen shows the number of power supply interruptions that the meter has encountered. After 9999 this value will start its count from 0. User can reset this count in the reset menu.

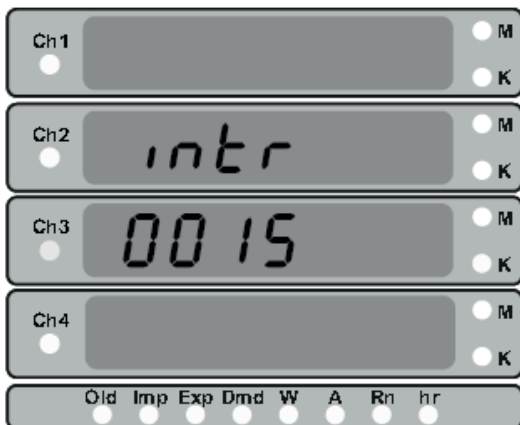

4.3.6 On hour

This screen shows the total number of hours the auxiliary supply has stayed on. Even if the Auxiliary supply is interrupted count of on hour will be maintained in internal memory & displayed in the "hhhhh.mm" format. For example if displayed count is 105000.10 it indicates 105000 hours and 10 minutes. After 999999.59 On hours display will restart from zero. The user can reset this value in reset parameters menu.



4.3.7 Run hour

This Screen shows the total no. of hours each of the load has been connected. Even if the Auxiliary supply is interrupted, count of Run hour will be maintained in internal memory & displayed in the format "hhhhh.mm".

For example if Displayed count is 105000.10 it indicates 105000 hours & 10 minutes. After 999999.59 run hours display will restart from zero. The user can reset these values in reset parameters menu.

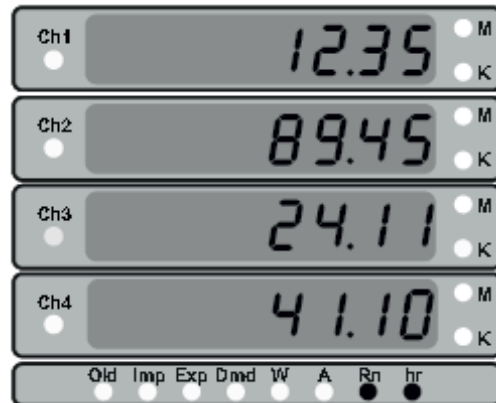
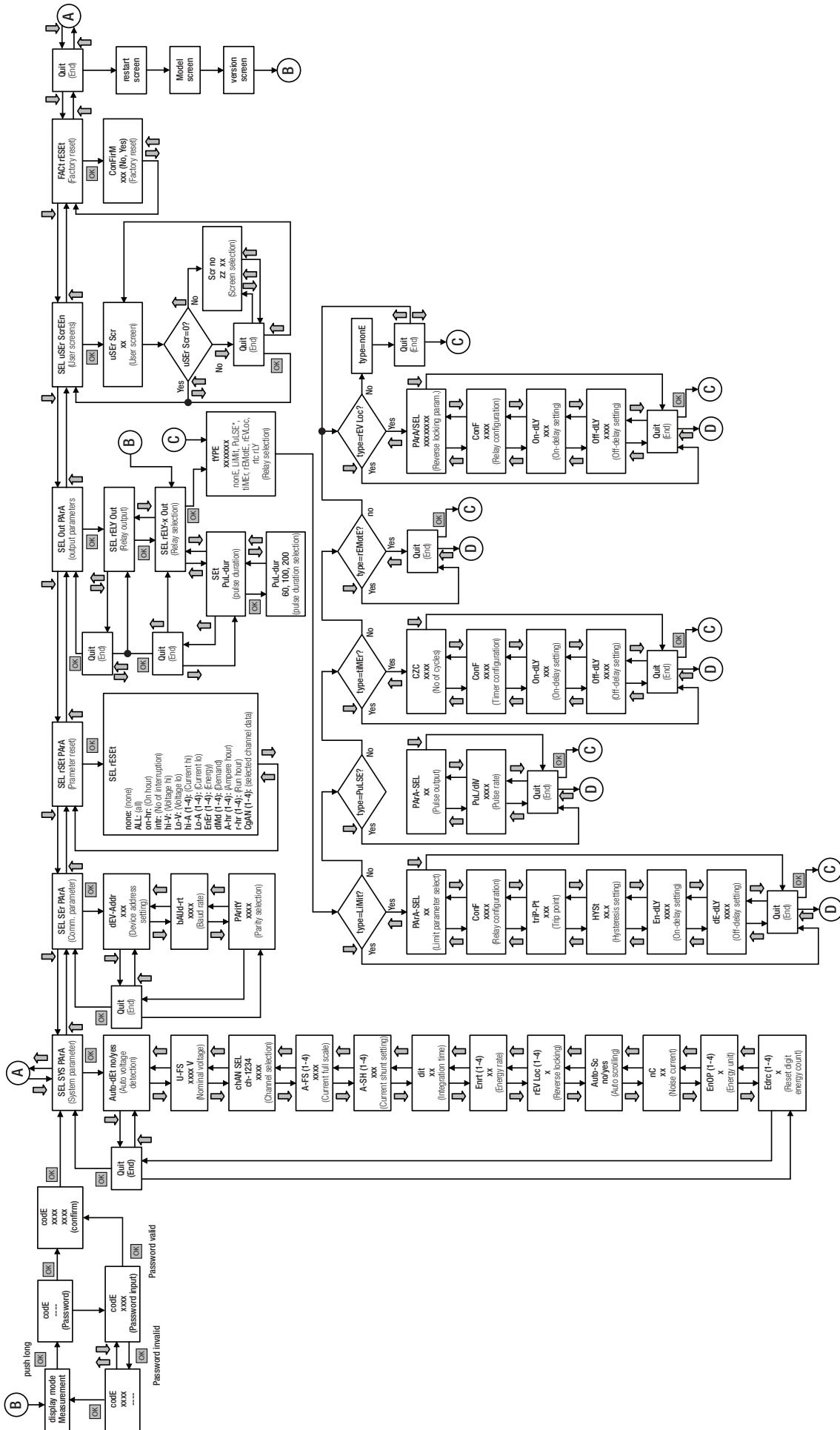

Table 2: Measurement Screen Parameters

Screen No.	Description Indicators	Parameter LED Status	Screen No.	Description Indicators	Parameter LED Status
1	Voltage	None	29	Min. Voltage	None
2	Current channel 1 - 4	A	30	Max. Current channel 1 - 4	A
3	Power channel 1 - 4	W	31	Min. Current channel 1 - 4	A
4	Total power import	Imp,W	32	Max Power Demand import channel 1 - 4	Imp,W,Dm
5	Total power export	Exp,W	33	Max Power Demand export channel 1 - 4	Exp,W,Dm
6	Energy import channel 1 - 4	Imp,W,hr	34	Max Current Demand import channel 1 - 4	Imp,A,Dm
7	Overflow counter Energy import	Imp,W,hr	35	Max Current Demand export channel 1 - 4	Exp,A,Dm
8	Energy export channel 1 - 4	Exp,W,hr	36	No of Interruptions	None
9	Overflow counter Energy export	Exp,W,hr	37	Energy import channel 1 - 4 old	Imp,W,hr,Old
10	Total energy import	Imp,W,hr	38	Energy import channel 1 - 4 Overload counter old	Imp,W,hr,Old
11	Total energy export	Exp,W,hr	39	Energy export channel 1 - 4 old	Exp,W,hr,Old
12	Ampere hour import channel 1 - 4	Imp,A,hr	40	Energy export channel 1 - 4 Overload counter old	Exp,W,hr,Old
13	Ampere hour import channel 1 - 4 Overload counter	Imp,A,hr	41	Ampere hour import channel 1 - 4 old	Imp,A,hr,Old
14	Ampere hour export channel 1 - 4	Exp,A,hr	42	Ampere hour export channel 1 - 4 Overload counter old	Imp,A,hr,Old
15	Ampere hour export channel 1 - 4 Overload counter	Exp,A,hr	43	Ampere hour export channel 1 - 4 old	Exp,A,hr,Old
16	Total Ampere hour import	Imp,A,hr	44	Ampere hour export channel 1 - 4 Overload counter old	Exp,A,hr,Old
17	Total Ampere hour export	Exp,A,hr	45	Max Power Demand import channel 1 - 4 old	Imp,W,Dm,Old
18	Power Demand import channel 1 - 4	Imp,W,Dm	46	Max Power Demand export channel 1 - 4 old	Exp,W,Dm,Old
19	Power Demand export channel 1 - 4	Exp,W,Dm	47	Max Current Demand import channel 1 - 4 old	Imp,A,Dm,Old
20	Total Power Demand import	Imp,W,Dm	48	Max Current Demand export channel 1 - 4 old	Exp,A,Dm,Old
21	Total Power Demand export	Exp,W,Dm	49	No of Interruptions old	Old
22	Current Demand import channel 1 - 4	Imp,A,Dm	50	On hour old	Old
23	Current Demand export channel 1 - 4	Exp,A,Dm	51	Run hour channel 1 - 4 Old	Old,Rn,hr
24	Total Current Demand import	Imp,A,Dm	52	Timer 1 screen	None
25	Total Current Demand export	Exp,A,Dm	53	Timer 2 screen	None
26	On hour	None	54	Timer 3 screen	None
27	Run hour channel 1 - 4	Rn-hr	55	Timer 4 screen	None
28	Max. Voltage	None			

5. Setup screen



6. Programming

The following sections comprise step by step procedures for configuring the BM1450 for individual user requirements. To access the set-up screens press and hold the "OK" key for 2 seconds. This will take the User into the Password Protection Entry Stage (Section 6.1).

6.1 Password Protection

Password protection can be enabled to prevent unauthorised access to setup screens. If no password is present (0000), press the "OK" key on the password input screen and you will be taken directly to the Confirm password screen. Password protection is activated with a four-digit number other than 0000. The setting of 0000 as password blocks the password protection.

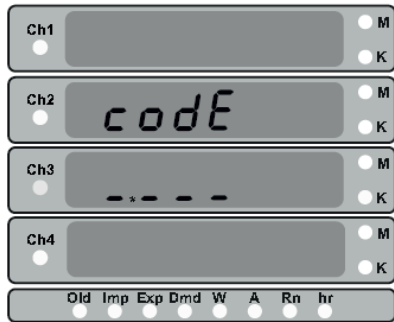

Enter the password and enter the first digit. (Displayed by the flashing decimal point *). Press the key "↓ Down" or "↑ UP" to increase or decrease the value of the digit. The value can be set from 0 to 9. After reaching the desired number, press the "OK" button to confirm and you will be taken to the next digit. The decimal point next to the second digit starts flashing. Repeat the above steps until you have entered all four digits. Pressing the "OK" key after entering the last digit will take you to the confirmation screen.



If the user now presses the "OK" button, there are two options for the next screen.

1. If the entered password is correct, this is displayed again in the fourth display line.

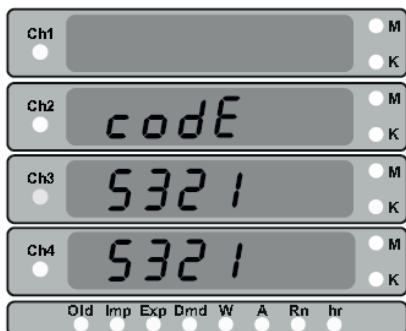

By pressing the "↓ DOWN" or "↑ UP" button, the user enters the password processing mode. A new password can be entered here. The work steps are the same as described above.

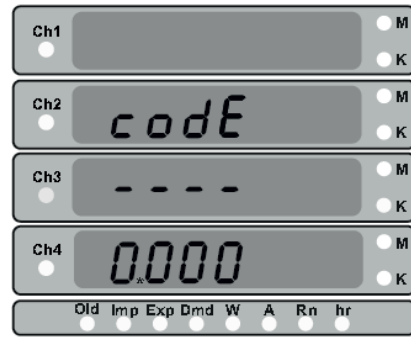

After editing the last digit, the newly set password is displayed on the third and fourth lines.

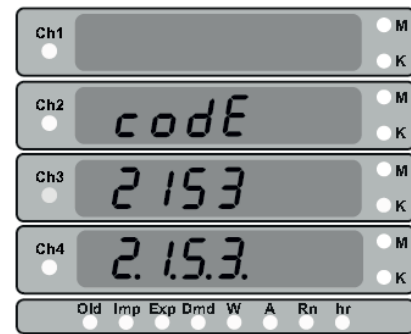

Press the "OK" button to enter the user directly into the setup menu. Pressing the "↓ DOWN" or "↑ UP" key allows the user to edit the password.

2. If the entered password does not match the current password, incorrect password is displayed in the display.

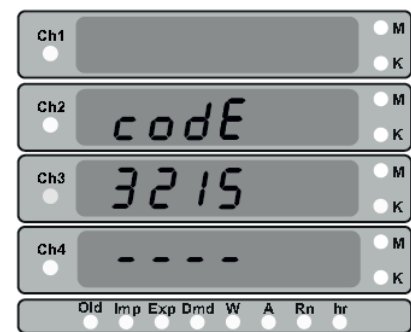

Press the "OK" button to enter the measurement screen. Pressing the "↓ DOWN" or "↑ UP" allows the user to enter the password again.

6.2 System Parameter Selection Screen

The first menu in the setup menu is the System Parameters menu. In this menu you can configure the various system parameters which are available for the system and are available in the device. Press the "↓ DOWN" or "↑ UP" button to navigate through the individual screens in the menu. (see flow chart)

```
SEL
SYS
PARA
```

6.2.1 Automatic Voltage Detection

This screen allows you to set the value of the rated voltage according to the input voltage.

```
Auto-dEt
```

Press "Yes" to set the nominal voltage value. The following table shows the different nominal voltage values for the different input voltage values.

Table 3: Automatic nominal voltage detection

Nominal voltage	Input voltage
10...60 V	
12	< 18 V
24	≥ 18 V & < 36 V
48	≥ 36 V & < 56 V
60	> 56 V
61...200 V	
72	< 90 V
110	≥ 90 V & < 135 V
160	≥ 135 V & < 180 V
200	> 180 V
201...1000 V	
220	< 235 V
380	≥ 235 V & < 450 V
500	≥ 450 V & < 600 V
750	≥ 600 V & < 800 V
1000	> 800 V

6.2.2 Nominal Voltage

With this screen, the user can set the value of the nominal voltage for the meter. One of the following three ranges can be set.

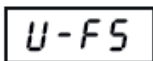

- 10...60 V
- 61...200 V
- 201...1000 V

Note: If you change this value, a "Reset" is performed. That all stored parameter values are deleted.

6.2.3 Channel Selection

The active channels "1234" can be selected with this screen. The device displays only the selected channels.

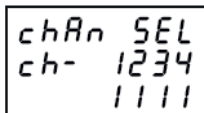

Press the "OK" button to go to the first channel. Select between "1" or "0". Confirm with the "OK" button to go to the next channel. Repeat this process until you have defined all four channels.

6.2.4 Current Full Scale Value

This screen allows the user to set the nominal nominal current per channel without shunt rating. The values shown here represent the currents in amps. The setting range of these values is 1 ... 20000 A. This screen only shows the settings of the active channels. The corresponding LED for each selected channel is green.

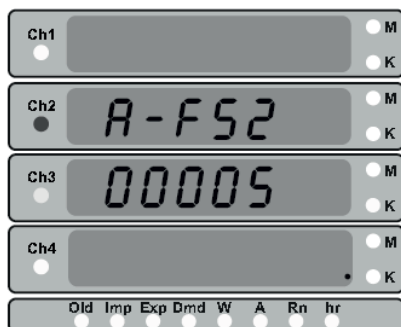
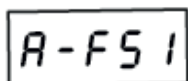

Note: If you change this value, a "Channel Reset" is performed. That all stored parameter values for this specific channel are deleted.

6.2.5 Current Shunt Value

This value shows the voltage drop generated by the shunt on the channel. This value can be in the range of 50 ... 150 mV can be set.

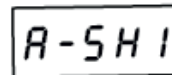

This screen only shows the settings of the active channels. The corresponding LED for each selected channel is green.



Note: If you change this value, a "Channel Reset" is performed. That all stored parameter values for this specific channel are deleted.

6.2.6 Demand Integration Time

This value indicates the time period in minutes to be used to integrate the power and power readings. The range for this value is 1 ... 30 minutes.

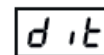

6.2.7 Energy Update Rate

This value is the energy updating rate in minutes and can be set from 1 ... 60 min.

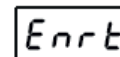

The power value is updated in Modbus registers 30171 to 30201 and 44267 to 44297 according to the set time. This screen only shows the settings of the active channels. The corresponding LED for each selected channel is green..

6.2.8 Reverse Locking

This screen shows the parameter for reverse locking of channels. Reverse locking is when the current or power is in the opposite direction of the desired direction, the energy and/or ampere-hour accumulation is stopped for the related channel. The setting will only be shown for the active channels and the corresponding channel LED will glow green. The parameter options are shown below. The energy locking will depend on power direction and the ampere-hour locking will depend on current direction.

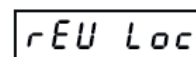
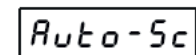

Table 4

Code	Value
0	Rev Lock Off
1	Positiv / Import
2	Negative / Export

6.2.9 Auto Scrolling

This screen allows user to enable or disable automatic screen scrolling. This feature is disabled by default. The options for this parameter are "yes" or "no".



6.2.10 Noise Current

This screen allows user to set low noise current cutoff. The range for this value is 0 - 30 % of nominal value. By default it is set to 0 %.

nc

6.2.11 Energy Output

With this value, the user can set the desired energy measuring unit Wh, kWh or MWh. The setting options are 1, 2, or 3, which identifies the unit as described in the table below.

EnoP

Table 5

Code	Unit
1	Wh
2	kWh
3	MWh

Note: The energy measurement in the "Wh" unit is blocked at a rated power of > 60 kW. The meter automatically switches to "kWh" if this condition is true.

6.2.12 Energy Digit Reset Count

This screen allows the user to set the maximum power points before starting at zero. The options for this setting are 6, 7 or 8 digits.

Edrc

6.3 Selection of Communication Parameters

Various communication parameters are selected in this display, for example "address", "RS485 parity", "RS485 baud rate". These settings apply only to Modbus.

SEL
SEr
PARA

6.3.1 Address Setting

In this display, the user can set the Modbus communication parameters for the devices. The range allowed for the address is 1 to 247.

dEU-Addr

6.3.2 Baud Rate

In this display, the user sets the baud rate of the RS485 port. The options for this setting are 4800, 9600, 19200, 38400, and 57600. The default value is set to 9600.

bAUD-rt

6.3.3 Parity

In this display, the user sets the parity and number of stop bits of the RS 485 port. The options for this value are as follows.

PARity

- no1:** no parity, 1 stop bit
- no2:** no parity, 2 stop bits
- even:** even parity, 1 stop bit
- odd:** odd parity, 1 stop bit

By default, the value for this parameter is set as no1.

6.4 Reset Parameter Selection

This screen allows the user to reset various stored parameters. When the reset is performed, the current register values are moved to corresponding "old" registers. The various reset parameters are listed below.

SEL
rSEt

- none:** No parameter is reset
- on-hr:** On hour is reset
- hi-V:** Higher voltage is reset
- hi-A*:** Higher current is reset
- EnEr*:** Energy is reset
- A-hr*:** Ampere hour is reset
- CHAN*:** Selected channel data is reset
- All:** All parameters are reset
- intr:** Interruptions is reset
- Lo-V:** Lower voltage is reset
- Lo-A*:** Lower current is reset
- dMd*:** Demand is reset
- r-hr*:** Run hour is reset

* These parameters reset channelwise.

6.5 Output Parameter Selection

In this menu the user can configure the output parameters available in the measuring device.

SEL
Out
PARA

6.5.1 Select Relay Output

On this screen the user can select relay as the output option and can decide which of the available relay to be used for his/her application.

SEL
rELY
Out

On selecting a relay, the user will be taken to the type selection screen, which prompts him to select an option out of seven available. The options are as following.

TYPE

1. 0 = None
2. 1 = Limit
3. 2 = Pulse
4. 3 = Timer
5. 4 = Remote
6. 5 = Reverse Lock

The "none" option implies that the relay is disabled.

6.5.1.1 Limit Relay Configuration

These parameters will decide the operation of limit relay.

6.5.1.1.1 Limit Parameter

The user can assign any one out of available options for limit relay.

PARA-SEL

Table 6: Parameters for limit value output

Parameter No.	Parameter	Range
0	None	--
1	Voltage	±10...±120%
2	Current channel 1	±10...±120%
3	Power channel 1	±10...±120%
4	Power Demand import channel 1	10...120%
5	Power Demand export channel 1	10...120%
6	Current Demand import channel 1	10...120%
7	Current Demand export channel 1	10...120%
8	Max Power Demand import channel 1	10...120%
9	Max Power Demand export channel 1	10...120%
10	Max Current Demand import channel 1	10...120%
11	Max Current Demand export channel 1	10...120%
12	Ampere hour import channel 1	10...9999999
13	Ampere hour export channel 1	10...9999999
14	Energy import channel 1	10...9999999
15	Energy export channel 1	10...9999999
16	Current channel 2	±10...±120%
17	Power channel 2	±10...±120%
18	Power Demand import channel 2	10...120%

19	Power Demand export channel 2	10...120%
20	Current Demand import channel 2	10...120%
21	Current Demand export channel 2	10...120%
22	Max Power Demand import channel 2	10...120%
23	Max Power Demand export channel 2	10...120%
24	Max Current Demand import channel 2	10...120%
25	Max Current Demand export channel 2	10...120%
26	Ampere hour import channel 2	10...9999999
27	Ampere hour export channel 2	10...9999999
28	Energy import channel 2	10...9999999
29	Energy export channel 2	10...9999999
30	Current channel 3	±10...±120%
31	Power channel 3	±10...±120%
32	Power Demand import channel 3	10...120%
33	Power Demand export channel 3	10...120%
34	Current Demand import channel 3	10...120%
35	Current Demand export channel 3	10...120%
36	Max Power Demand import channel 3	10...120%
37	Max Power Demand export channel 3	10...120%
38	Max Current Demand import channel 3	10...120%
39	Max Current Demand export channel 3	10...120%
40	Ampere hour import channel 3	10...9999999
41	Ampere hour export channel 3	10...9999999
42	Energy import channel 3	10...9999999
43	Energy export channel 3	10...9999999
44	Current channel 4	±10...±120%
45	Power channel 4	±10...±120%
46	Power Demand import channel 4	10...120%
47	Power Demand export channel 4	10...120%
48	Current Demand import channel 4	10...120%
49	Current Demand export channel 4	10...120%
50	Max Power Demand import channel 4	10...120%
51	Max Power Demand export channel 4	10...120%
52	Max Current Demand import channel 4	10...120%
53	Max Current Demand export channel 4	10...120%
54	Ampere hour import channel 4	10...9999999
55	Ampere hour export channel 4	10...9999999
56	Energy import channel 4	10...9999999
57	Energy export channel 4	10...9999999
58	Total Power import	10...120%
59	Total Power export	10...120%
60	Total Power Demand import	10...120%
61	Total Power Demand export	10...120%
62	Total Current Demand import	10...120%
63	Total Current Demand export	10...120%
64	Total Ampere hour import	10...9999999
65	Total Ampere hour export	10...9999999
66	Total Energy import	10...9999999
67	Total Energy export	10...9999999

Note: 1. Nominal power = Nom U x Nom I
2. Range in % of nominal value

6.5.1.1.2 Limit Configuration

This screen allows the user to select the relay configuration out of 4 available options.

CONF

1. Hi-E
2. Hi-d
3. Lo-E
4. Lo-d

6.5.1.1.3 Trip Point

This is the value for selected parameter limit which is used as a reference for relay tripping. It is represented as percentage value. The various ranges for various parameters are shown in Table 5. Press the Enter key to edit the approach point. Then press the “ DOWN” or “ UP” button to select a positive or a negative approach point. Then press the Enter key to edit the appropriate number. Press the “ DOWN” or “ UP” button to increase or decrease the digits. Press the Enter key to confirm the newly changed starting point.

tr, P-Pt

6.5.1.1.4 Hysteresis

With this screen, the user sets the hysteresis for the assigned relay. The value of the hysteresis can range from 0.5 ... 50% and is calculated to the trigger point value.

HYST

6.5.1.1.5 Energizing Delay

With this screen, the user sets the switch-on delay for the assigned relay. The value for this parameter can range from 0001 to 9999.

En-dLY

6.5.1.1.6 De-energizing Delay

With this screen, the user sets the switch-on delay for the assigned relay. The value for this parameter can range from 0001 to 9999.

dE-dLY

6.5.1.2 Pulse Relay Configuration

Pulse relay can be used with a mechanical counter to measure the energy. It is a potential-free, very fast acting relay contact.

6.5.1.2.1 Pulse Parameter Selection

This parameter decides which measuring parameter the pulse should occur. The options for this setting are 0 ... 7.

PARA-SEL

Table 7: Parameters Pulse output

Code	Configuration	Code	Configuration
0	Energy import ch 1	4	Energy export ch 1
1	Energy import ch 2	5	Energy export ch 2
2	Energy import ch 3	6	Energy export ch 3
3	Energy import ch 4	7	Energy export ch 4

6.5.1.2.2 Pulse Divisor

This parameter determines how much energy units a pulse should appear at the output. The energy pulse rate divisor is set with the display. Divisor values can be selected from 1, 10, 100, 1000 in Wh.

PUL-dIU

6.5.1.2.3 Pulse duration

With this screen, the user sets the start-up time of the output pulse in milliseconds. The options for this parameter are 60, 100 and 200 ms.

PUL - dur

6.5.1.3 Timer

This menu contains the parameters for the timer output configuration.

6.5.1.3.1 Number of Cycles

This value determines how often the timer repeats the changeover once it has been started. If this value is set to 0, the timer repeats until it is stopped.

CYC

6.5.1.3.2 Timer Configuration

The timer configuration determines the relay configuration for the timer output. There are two options for this parameter:

CONF

1. Energize on start
2. De-energize on start

6.5.1.3.3 On Delay

On delay is the time in seconds taken by the relay in timer configuration before tripping after it is started. The value for this parameter can range from 0001 to 9999.

On - dLY

6.5.1.3.4 Off Delay

Off delay is the time in seconds taken by the relay in timer configuration before coming out of the trip state, after it has tripped. The value for this parameter can range from 0001 to 9999.

OFF - dLY

6.5.1.4 Remote Operation

In this mode the meter configures the relay to be controlled via RS485 modbus communication.

6.5.1.5 Reverse Locking Relay

This relay can be used to control some instrument when reverse polarity of current or powers is observed.

6.5.1.5.1 Parameter selection

This parameter decides on which channel's reverse locking parameter, the relay should trip. There are four options for this parameter.

Table 8:

Code	Value
0	None
1	Rev Lock channel 1
2	Rev Lock channel 2
3	Rev Lock channel 3
4	Rev Lock channel 4

PARA - SEL

The number of options on this screen will depend on how many channels are configured for reverse locking in system parameters menu.

6.5.1.5.2 Relay Configuration

This parameter decides the relay configuration for relay in reverse locking mode. There are two options for this parameter.

CONF

1. Energize
2. De-energize

6.5.1.5.3 On Delay

On delay is the time in seconds taken by the relay in reverse locking configuration before tripping, after a reverse locking is observed. The value for this parameter can range from 0001 to 9999.

On - dLY

6.5.1.5.4 Off Delay

Off delay is the time in seconds taken by the relay in reverse locking configuration, after a normal condition has observed. The value for this parameter can range from 0001 to 9999.

OFF - dLY

6.6 User Assignable Screen Setup

In this menu, the user can configure the user screens.

SEL
USER
SCREEN

6.6.1 Number of User Screens

On this screen, the user can set the number of user screens to be displayed. Options for this parameter are 00 - 10. The value 00 will denote that the user screens are disabled and the user screen selection screen will not show up.

USER SCR

6.6.1.1 User Screen no. Selection

This screen shows two parameters.

1. Screen
2. Screen number

SCR no

The screen will scroll through the number of screen selected in previous screen and the user can see/change the screen number in editing mode. The range for this value is 01 - 56. Refer table-3.

6.7 Factory Reset

In this menu, the user can factory reset the meter. This will erase all data from the meter and set all setup parameters to their default values.

FACT
RESET

6.7.1 Factory Reset Confirmation

This screen has the options, no/yes. Selecting 'yes' will start the factory reset process and selecting 'no' will do nothing.

CONF IRN

7. Relay Output

The SIRAX BM1450 contains 4 relays for limit value output or pulse output.

7.1 Limit Relay

Limit relay can be used to monitor the measured parameter in comparison to a set limit.

Relay Configuration

The limit relay can be configured to one of the following four options:

3. Hi-E High alarm, energized relay
4. Hi-d High alarm, de-energized relay
5. Lo-E Low alarm, energized relay
6. Lo-d Low alarm, de-energized relay

The starting point, hysteresis, switch-on delay and switch-off delay can be selected by the user in the limit relay.

7.3 Timer Output

Timer output can be used to operate the Relay in a cyclic manner. The user can define the ON period and OFF period and also the number of times this cycle is to be repeated. The number of Cycles (N) can be indefinite or 1 to 9999.

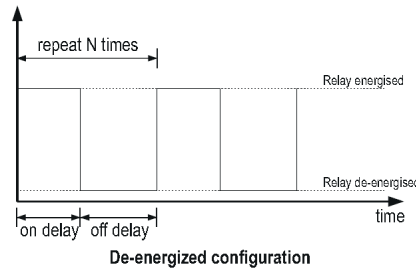
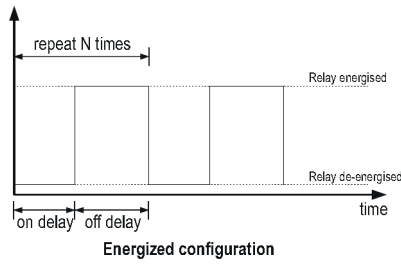

8. Service, maintenance and disposal



For devices that have not been opened in the factory, no warranty or guarantee can be assumed.

8.1 Repair work and modifications

Repair work and modifications shall exclusively be carried out by the manufacturer. Do not open the housing of the device. In case of any tampering with the device, the warranty claim shall lapse. We reserve the right of changing the product to improve it.

8.2 Calibration and new adjustment

Each device is adjusted and checked before delivery. The condition as supplied to the customer is measured and stored in electronic form. The uncertainty of measurement devices may be altered during normal operation if, for example, the specified ambient conditions are not met.

8.3 Cleaning

The display and the operating keys should be cleaned in regular intervals. Use a dry or slightly moist cloth for this.



Damage due to detergents

Detergents may not only affect the clearness of the display but also can damage the device. Therefore, do not use detergents.

8.4 Disposal



The disposal of devices and components may only be realised in accordance with good professional practice observing the country-specific regulations. Incorrect disposal can cause environmental risks.

8.5 Return

All devices delivered to Camille Bauer Metrawatt AG shall be free of any hazardous contaminants (acids, lyes, solutions, etc.). Use original packaging or suitable transport packaging to return the device.



Damage by returning

Damages caused by improper returning, no warranties or guarantees can be given.

9. Technical data

Inputs

Voltage input

Nominal input voltage:	10 ... 60 V (Article-No. 177065) 61 ... 200 V (Article-No. 177073) 201 ... 1000 V (Article-No. 177081)
Max continuous input voltage:	125 % of nominal value
Measuring range Voltage:	$\pm 2 \% \dots \pm 125 \%$ of nominal value
Rated load voltage:	< 0.4 W
Overload:	> 126 % of nominal value
Max short-term input voltage:	2 x nominal value (1s application 10 times in intervals of 10s)

Current input

Full scale setting range:	1 ... 20 kA
No. of channels:	4
Current sensor:	External Shunt
Shunt setting range:	50 ... 150 mV
Max continuous input current:	125 % of nominal value
Measuring range current:	$\pm 2 \% \dots \pm 125 \%$ of nominal value
Rated load current:	< 0.1 W per channel
Overload:	> 126 % of nominal value
Max short-term input current:	20 x nominal value (1s Application 5 times in intervals of 5 min.)

Power supply

Nominal voltage:	60 ... 300 V AC/DC
Rated value for AC supply:	230 V AC/DC; 50/60 Hz
Frequency:	45 ... 65 Hz
Rated load Power:	< 6 VA

Accuracy

Reference conditions:	23 °C \pm 2 °C
Voltage, current:	$\pm 0.5 \%$ of nominal value ($\pm 5 \% \dots \pm 120 \%$)
Power:	$\pm 0.5 \%$ of nominal value ($\pm 5 \% \dots \pm 120 \%$)
Energy:	Class 1
Temperature drift:	$\pm 0.05 \% / ^\circ\text{C}$

Operation and display

Controls

User interface:	3 push buttons
-----------------	----------------

Display

Type:	4 line, 8-digit LED Display
Display height:	9 mm
Update rate:	approx. 1 Sek.
Display range voltage:	0 ... ± 9999
Display range current:	0 ... ± 9999
Display range power:	0 ... ± 9999
Display range energy (import & export):	0 ... ± 99999999

Mechanical attributes

Orientation:	Any
Material:	Polycarbonate
Flammability:	V-0 acc. to UL94, self-extinguishing, non-dripping, free of halogen
Weight:	approx. 620 g
Terminals:	Screw-type terminals
Abmessungen	See dimensional drawing

Environmental conditions

Operating temperature:	- 10 °C ... + 55 °C
Storage temperature:	- 20 °C ... + 70 °C
Relative humidity:	< 90 % RH, non condensing
Warm up time:	3 minute (minimum)
Vibration resistance (acc. to IEC 60068-2-6):	10 ... 55 ... 10 Hz, 0.15 mm Amplitude, je 10 Zyklen pro Achse
Shock resistance (acc. to IEC 60068-2-27):	15g in 3 planes
Operating altitude:	≤ 2000 m above sea level
Only to be used in interior rooms!	

Safety

EMC (acc. to IEC 61000-4-3 & IEC 61326-1):	10 V/m min - Level 3
Protection class:	II
Pollution degree:	2

Enclosure (acc. to IEC 60529):

IP 54 (front), IP 20 (housing/terminals)

Measurement category:

Measuring inputs: 1000 V CAT II, 600 V CAT III

Power supply: 300 V CAT III

High voltage test (acc. to IEC 61010-1-2010):

Frequency AC 50 Hz, test duration 60 sec.

- Housing against all electrical circuits 4400 V AC
- Power supply against all other circuits 3700 V AC
- Inputs against all other circuits 2200 V AC
- Relay to relay 2200 V AC
- Bus-RS485 against all other circuits 2200 V AC

Interface

Modbus/RTU

via plug-in terminal (B, A, Gnd)

Protocol:

Modbus/RTU

Physics:

RS485, max 1200 m

Baud rate:

4800, 9600, 19200, 38400, 57600 Baud

Parity:

Odd or Even, with 1 stop bit, Or None with 1 or 2 stop bits

Number of participants:

≤ 32

Outputs

Relaiy

via plug-in terminal

Number of relays:

4 (freely selectable for limit, pulse or timer output)

Switching voltage:

250 V AC / 30 V DC

Switching current:

5 A

9.1 Dimensional drawing

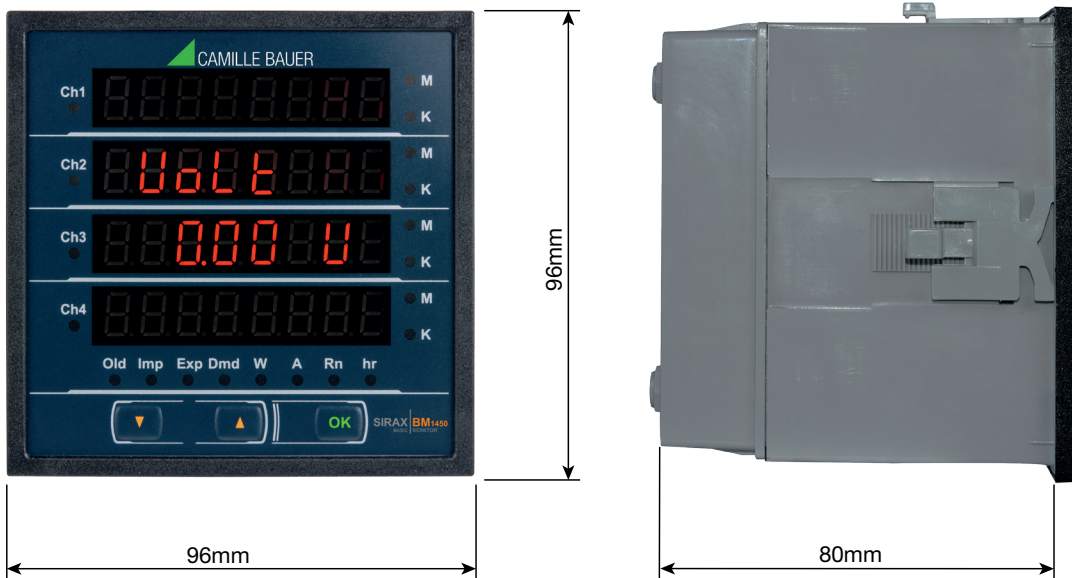

9.2 Connection and programming via RS485 (Modbus) interface

If the transmitter is programmed via the RS485 interface and Modbus, the following steps must be followed:

Step 1: Connection

Connect the Modbus cable according to the connection diagram in chapter 4.2.3. Please also note the versions in the interface definition Modbus (RS485).

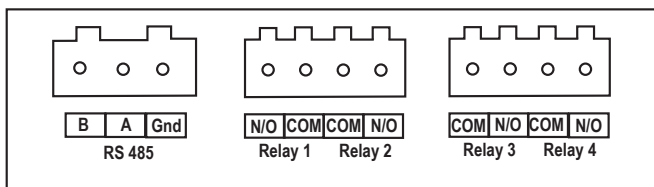

Step 2: Programming

The SIRAX BM1450 is programmed via the Modbus RTU interface. Please refer to the detailed Modbus descriptions in chapter 10. The power supply must be connected to the SIRAX BM1450 before it can be programmed.

10. Interface definition Modbus RTU

SIRAX BM1450 supports Modbus RTU protocol (RS485).

The permissible address range for the BM1450 is between 1 and 247. Broadcast Mode (address 0) is not allowed.

The maximum latency time of an BM1450 is 200ms i.e. this is the amount of time that can pass before the first response character is output. After sending any query through software (of the Master), it must allow 200ms of time to elapse before assuming that the BM1450 is not going to respond. If slave does not respond within 200 ms, Master can ignore the previous query and can issue fresh query to the slave.

10.1 Modbus functions

Following code functions are provide:

Function code	Function	Address
03	Read holding registers	40001 to 40079
04	Read input registers	30001 to 30231
16	Presets multiple registers	40001 to 40079

The slave only answers Modbus requests with a valid parity and correct checksum. The slave responds with the following exception codes (0x80 + function code) to requests with unsupported functions, unimportant data addresses or invalid data values:

01	Illegal function	The function code is not supported.
02	Illegal data address	Attempt to access an invalid address or an attempt to read or write part of a floating point value.
03	Illegal data value	Attempt to set a floating point variable to an invalid value.

Access to 3X and 4X registers for reading measured values

Example: Current Ch 2 from 3X: Start address = 00 04 Number of Register = 02
 Power Ch 1 from 4X: Start address = 10 0A Number of Register = 02

Query for 3X read:

Device address	Function code	Start adress Hi	Start adress Lo	No. of Register Hi	Datenbytes	CRC Low	CRC High
01 (Hex)	04 (Hex)	00 (Hex)	04 (Hex)	00 (Hex)	02 (Hex)	30 (Hex)	0A (Hex)

3X Response: Current Ch2 (219.254 A)

Device address	Function code	Byte count	Data Register 1 High Byte	Data Register 1 Low Byte	Data Register 2 High Byte	Data Register 2 Low Byte	CRC Low	CRC High
01 (Hex)	04 (Hex)	04 (Hex)	43 (Hex)	5B (Hex)	41 (Hex)	21 (Hex)	6F (Hex)	9B (Hex)

Byte Count : Total number of data bytes received.

Query for 4X read:

Device address	Function code	Start adress Hi	Start adress Lo	No. of Register Hi	Datenbytes	CRC Low	CRC High
01 (Hex)	03 (Hex)	10 (Hex)	0A (Hex)	00 (Hex)	02 (Hex)	E0 (Hex)	C9 (Hex)

4X Response: Power Ch 1 (2000W)

Device address	Function code	Byte count	Data Register 1 High Byte	Data Register 1 Low Byte	Data Register 2 High Byte	Data Register 2 Low Byte	CRC Low	CRC High
01 (Hex)	03 (Hex)	04 (Hex)	44 (Hex)	FA (Hex)	00 (Hex)	00 (Hex)	CE (Hex)	F2 (Hex)

Access to 4X Register zum Lesen und Schreiben von Messwerten

Example: Nominal voltage of 4X: Start address = 1A (Hex) Number of Register = 02

Query for 4X read:

Device address	Function code	Start adress Hi	Start adress Lo	No. of Register Hi	Datenbytes	CRC Low	CRC High
01 (Hex)	03 (Hex)	00 (Hex)	1A (Hex)	00 (Hex)	02 (Hex)	E5 (Hex)	CC (Hex)

4X Response: Nominal voltage 24V

Device address	Function code	Byte count	Data Register 1 High Byte	Data Register 1 Low Byte	Data Register 2 High Byte	Data Register 2 Low Byte	CRC Low	CRC High
01 (Hex)	03 (Hex)	04 (Hex)	41 (Hex)	C0 (Hex)	00 (Hex)	00 (Hex)	44 (Hex)	C6 (Hex)

Query for 4X writing: Change nominal voltage to 48V

Device address	Function code	Start address Hi	Start address Lo	No. of Register Hi	No. of Register Lo	Byte Count	Data Reg. 1 High Byte	Data Reg. 1 Low Byte	Data Reg. 2 High Byte	Data Reg. 2 Low Byte	CRC Low	CRC High
01 (Hex)	10 (Hex)	00 (Hex)	1A (Hex)	00 (Hex)	02 (Hex)	04 (Hex)	42 (Hex)	40 (Hex)	00 (Hex)	00 (Hex)	67 (Hex)	70 (Hex)

4X Response:

Device address	Function code	Data Register 1 High Byte	Data Register 1 Low Byte	Data Register 2 High Byte	Data Register 2 Low Byte	CRC Low	CRC High
01 (Hex)	10 (Hex)	00 (Hex)	1A (Hex)	00 (Hex)	02 (Hex)	60 (Hex)	0F (Hex)

10.2 Data types

All information are displayed as 32-bit float. There is no representation for floating point numbers in the Modbus specification. The IEEE 754 standard as the most often used standard for the representation of floating numbers is applied.

The first register contains the bits 16 – 31

The second register contains the bits 0 – 15

32-Bit Float (Real32)

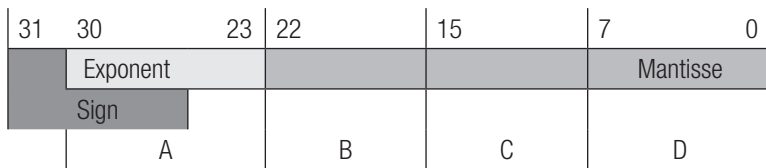

Table 10: 3X and 4X register addresses for measured parameters

Address (3X Register)	Address (4X Register)	Parameter	Parameter No.	Start address Hex 3X		Start address Hex 4X	
				High Byte	Low Byte	High Byte	Low Byte
30001	44097	Voltage	0	00	00	10	00
30003	44099	Current channel 1	1	00	02	10	02
30005	44101	Current channel 2	1	00	04	10	04
30007	44103	Current channel 3	3	00	06	10	06
30009	44105	Current channel 4	4	00	08	10	08
30011	44107	Power channel 1	5	00	0A	10	0A
30013	44109	Power channel 2	6	00	0C	10	0C
30015	44111	Power channel 3	7	00	0E	10	0E
30017	44113	Power channel 4	8	00	10	10	10
30019	44115	Total power import	9	00	12	10	12
30021	44117	Total power export	10	00	14	10	14
30023	44119	Energy import channel 1	11	00	16	10	16
30025	44121	Energy import channel 2	12	00	18	10	18
30027	44123	Energy import channel 3	13	00	1A	10	1A
30029	44125	Energy import channel 4	14	00	1C	10	1C
30031	44127	Energy export channel 1	15	00	1E	10	1E
30033	44129	Energy export channel 2	16	00	20	10	20
30035	44131	Energy export channel 3	17	00	22	10	22
30037	44133	Energy export channel 4	18	00	24	10	24
30039	44135	Total energy import	19	00	26	10	26
30041	44137	Total energy export	20	00	28	10	28

Continuation Table 10: 3X and 4X register addresses for measured parameters

Address (3X Register)	Address (4X Register)	Parameter	Parameter No.	Start address Hex 3X		Start address Hex 4X	
				High Byte	Low Byte	High Byte	Low Byte
30059	44155	Ampere hour import channel 1	29	00	3A	10	3A
30061	44157	Ampere hour import channel 2	30	00	3C	10	3C
30063	44159	Ampere hour import channel 3	31	00	3E	10	3E
30065	44161	Ampere hour import channel 4	32	00	40	10	40
30067	44163	Ampere hour export channel 1	33	00	42	10	42
30069	44165	Ampere hour export channel 2	34	00	44	10	44
30071	44167	Ampere hour export channel 3	35	00	46	10	46
30073	44169	Ampere hour export channel 4	36	00	48	10	48
30075	44171	Total Ampere hour import	37	00	4A	10	4A
30077	44173	Total Ampere hour export	38	00	4C	10	4C
30079	44175	Power demand import channel 1	39	00	4E	10	4E
30081	44177	Power demand import channel 2	40	00	50	10	50
30083	44179	Power demand import channel 3	41	00	52	10	52
30085	44181	Power demand import channel 4	42	00	54	10	54
30087	44183	Power demand export channel 1	43	00	56	10	56
30089	44185	Power demand export channel 2	44	00	58	10	58
30091	44187	Power demand export channel 3	45	00	5A	10	5A
30093	44189	Power demand export channel 4	46	00	5C	10	5C
30095	44191	Total power demand import	47	00	5E	10	5E
30097	44193	Total power demand export	48	00	60	10	60
30099	44195	Current demand import channel 1	49	00	62	10	62
30101	44197	Current demand import channel 2	50	00	64	10	64
30103	44199	Current demand import channel 3	51	00	66	10	66
30105	44201	Current demand import channel 4	52	00	68	10	68
30107	44203	Current demand export channel 1	53	00	6A	10	6A
30109	44205	Current demand export channel 2	54	00	6C	10	6C
30111	44207	Current demand export channel 3	55	00	6E	10	6E
30113	44209	Current demand export channel 4	56	00	70	10	70
30115	44211	Total Current demand import	57	00	72	10	72
30117	44213	Total Current demand export	58	00	74	10	74
30119	44215	Max voltage	59	00	76	10	76
30121	44217	Min voltage	60	00	78	10	78
30123	44219	Max current channel 1	61	00	7A	10	7A
30125	44221	Max current channel 2	62	00	7C	10	7C
30127	44223	Max current channel 3	63	00	7E	10	7E
30129	44225	Max current channel 4	64	00	80	10	80
30131	44227	Min current channel 1	65	00	82	10	82
30133	44229	Min current channel 2	66	00	84	10	84
30135	44231	Min current channel 3	67	00	86	10	86
30137	44233	Min current channel 4	68	00	88	10	88
30139	44235	Max power demand import channel 1	69	00	8A	10	8A
30141	44237	Max power demand import channel 2	70	00	8C	10	8C
30143	44239	Max power demand import channel 3	71	00	8E	10	8E
30145	44241	Max power demand import channel 4	72	00	90	10	90
30147	44243	Max power demand export channel 1	73	00	92	10	92
30149	44245	Max power demand export channel 2	74	00	94	10	94

Continuation Table 10: 3X and 4X register addresses for measured parameters

Address (3X Register)	Address (4X Register)	Parameter	Parameter No.	Start address Hex 3X		Start address Hex 4X	
				High Byte	Low Byte	High Byte	Low Byte
30151	44247	Max power demand export channel 3	75	00	96	10	96
30153	44249	Max power demand export channel 4	76	00	98	10	98
30155	44251	Max current demand import channel 1	77	00	9A	10	9A
30157	44253	Max current demand import channel 2	78	00	9C	10	9C
30159	44255	Max current demand import channel 3	79	00	9E	10	9E
30161	44257	Max current demand import channel 4	80	00	A0	10	A0
30163	44259	Max current demand export channel 1	81	00	A2	10	A2
30165	44261	Max current demand export channel 2	82	00	A4	10	A4
30167	44263	Max current demand export channel 3	83	00	A6	10	A6
30169	44265	Max current demand export channel 4	84	00	A8	10	A8
30171	44267	Update rate energy import channel 1 ON	85	00	AA	10	AA
30173	44269	Update rate energy import channel 2 ON	86	00	AC	10	AC
30175	44271	Update rate energy import channel 3 ON	87	00	AE	10	AE
30177	44273	Update rate energy import channel 4 ON	88	00	B0	10	B0
30179	44275	Update rate energy import channel 1 OFF	89	00	B2	10	B2
30181	44277	Update rate energy import channel 2 OFF	90	00	B4	10	B4
30183	44279	Update rate energy import channel 3 OFF	91	00	B6	10	B6
30185	44281	Update rate energy import channel 4 OFF	92	00	B8	10	B8
30187	44283	Update rate energy import channel 1 ON	93	00	BA	10	BA
30189	44285	Update rate energy import channel 2 ON	94	00	BC	10	BC
30191	44287	Update rate energy import channel 3 ON	95	00	BE	10	BE
30193	44289	Update rate energy import channel 4 ON	96	00	C0	10	C0
30195	44291	Update rate energy export channel 1 OFF	97	00	C2	10	C2
30197	44293	Update rate energy export channel 2 OFF	98	00	C4	10	C4
30199	44295	Update rate energy export channel 3 OFF	99	00	C6	10	C6
30201	44297	Update rate energy export channel 4 OFF	100	00	C8	10	C8
30203	44299	On hour	101	00	CA	10	CA
30205	44301	Run hour channel 1	102	00	CC	10	CC
30207	44303	Run hour channel 2	103	00	CE	10	CE
30209	44305	Run hour channel 3	104	00	D0	10	D0
30211	44307	Run hour channel 4	105	00	D2	10	D2
30213	44309	No. of interruptions	106	00	D4	10	D4
30215	44311	Energy import old channel 1	107	00	D6	10	D6
30217	44313	Energy import old channel 2	108	00	D8	10	D8
30219	44315	Energy import old channel 3	109	00	DA	10	DA
30221	44317	Energy import old channel 4	110	00	DC	10	DC
30223	44319	Energy import old channel 1 OFF	111	00	DE	10	DE
30225	44321	Energy import old channel 2 OFF	112	00	E0	10	E0
30227	44323	Energy import old channel 3 OFF	113	00	E2	10	E2
30229	44325	Energy import old channel 4 OFF	114	00	E4	10	E4
30231	44327	Energy export old channel 1	115	00	E6	10	E6
30233	44329	Energy export old channel 2	116	00	E8	10	E8
30235	44331	Energy export old channel 3	117	00	EA	10	EA
30237	44333	Energy export old channel 4	118	00	EC	10	EC
30239	44335	Energy export old channel 1 OFF	119	00	EE	10	EE
30241	44337	Energy export old channel 2 OFF	120	00	FO	10	FO

Continuation Table 10: 3X and 4X register addresses for measured parameters

Address (3X Register)	Address (4X Register)	Parameter	Parameter No.	Start address Hex 3X		Start address Hex 4X	
				High Byte	Low Byte	High Byte	Low Byte
30243	44339	Energy export old channel 3 OFF	121	00	F2	10	F2
30245	44341	Energy export old channel 4 OFF	122	00	F4	10	F4
30247	44343	Ampere hour import old channel 1	123	00	F6	10	F6
30249	44345	Ampere hour import old channel 2	124	00	F8	10	F8
30251	44347	Ampere hour import old channel 3	125	00	FA	10	FA
30253	44349	Ampere hour import old channel 4	126	00	FC	10	FC
30255	44351	Ampere hour export old channel 1	127	00	FE	10	FE
30257	44353	Ampere hour export old channel 2	128	01	00	11	00
30259	44355	Ampere hour export old channel 3	129	01	02	11	02
30261	44357	Ampere hour export old channel 4	130	01	04	11	04
30263	44359	Max power demand import old channel 1	131	01	06	11	06
30265	44361	Max power demand import old channel 2	132	01	08	11	08
30267	44363	Max power demand import old channel 3	133	01	0A	11	0A
30269	44365	Max power demand import old channel 4	134	01	0C	11	0C
30271	44367	Max power demand export old channel 1	135	01	0E	11	0E
30273	44369	Max power demand export old channel 2	136	01	10	11	10
30275	44371	Max power demand export old channel 3	137	01	12	11	12
30277	44373	Max power demand export old channel 4	138	01	14	11	14
30279	44375	Max current demand import old channel 1	139	01	16	11	16
30281	44377	Max current demand import old channel 2	140	01	18	11	18
30283	44379	Max current demand import old channel 3	141	01	1A	11	1A
30285	44381	Max current demand import old channel 4	142	01	1C	11	1C
30287	44383	Max current demand export old channel 1	143	01	1E	11	1E
30289	44385	Max current demand export old channel 2	144	01	20	11	20
30291	44387	Max current demand export old channel 3	145	01	22	11	22
30293	44389	Max current demand export old channel 4	146	01	24	11	24
30295	44391	On hour old	147	01	26	11	26
30297	44393	Run hour old channel 1	148	01	28	11	28
30299	44395	Run hour old channel 2	149	01	2A	11	2A
30301	44397	Run hour old channel 3	150	01	2C	11	2C
30303	44399	Run hour old channel 4	151	01	2E	11	2E
30305	44401	No. of interruptions old	152	01	30	11	30
30307	44403	Energy import channel 1 OFF	153	01	32	11	32
30309	44405	Energy import channel 2 OFF	154	01	34	11	34
30311	44407	Energy import channel 3 OFF	155	01	36	11	36
30313	44409	Energy import channel 4 OFF	156	01	38	11	38
30315	44411	Energy export channel 1 OFF	157	01	3A	11	3A
30317	44413	Energy export channel 2 OFF	158	01	3C	11	3C
30319	44415	Energy export channel 3 OFF	159	01	3E	11	3E
30321	44417	Energy export channel 4 OFF	160	01	40	11	40
30323	44419	Total energy import OFF	161	01	42	11	42
30325	44421	Total energy export OFF	162	01	44	11	44
30327	44423	Ampere hour import channel 1 OFF	163	01	46	11	46
30329	44425	Ampere hour import channel 2 OFF	164	01	48	11	48
30331	44427	Ampere hour import channel 3 OFF	165	01	4A	11	4A
30333	44429	Ampere hour import channel 4 OFF	166	01	4C	11	4C

Continuation Table 10: 3X and 4X register addresses for measured parameters

Address (3X Register)	Address (4X Register)	Parameter	Parameter No.	Start address Hex 3X		Start address Hex 4X	
				High Byte	Low Byte	High Byte	Low Byte
30335	44431	Ampere hour export channel 1 OFF	167	01	4E	11	4E
30337	44433	Ampere hour export channel 2 OFF	168	01	50	11	50
30339	44435	Ampere hour export channel 3 OFF	169	01	52	11	52
30341	44437	Ampere hour export channel 4 OFF	170	01	54	11	54
30343	44439	Total ampere hour import OFF	171	01	56	11	56
30345	44441	Total ampere hour export OFF	172	01	58	11	58
30347	44443	Ampere hour import old channel 1 OFF	173	01	5A	11	5A
30349	44445	Ampere hour import old channel 2 OFF	174	01	5C	11	5C
30351	44447	Ampere hour import old channel 3 OFF	175	01	5E	11	5E
30353	44449	Ampere hour import old channel 4 OFF	176	01	60	11	60
30355	44451	Ampere hour export old channel 1 OFF	177	01	62	11	62
30357	44453	Ampere hour export old channel 2 OFF	178	01	64	11	64
30359	44455	Ampere hour export old channel 3 OFF	179	01	66	11	66
30361	44457	Ampere hour export old channel 4 OFF	180	01	68	11	68
30363	44459	Status Relay 1	181	01	6A	11	6A
30365	44461	Status Relay 2	182	01	6C	11	6C
30367	44463	Status Relay 3	183	01	6E	11	6E
30369	44465	Status Relay 4	184	01	70	11	70
30371	44467	On delay Timer 1	185	01	72	11	72
30373	44469	On delay Timer 2	186	01	74	11	74
30375	44471	On delay Timer 3	187	01	76	11	76
30377	44473	On delay Timer 4	188	01	78	11	78
30379	44475	OFF delay Timer 1	189	01	7A	11	7A
30381	44477	OFF delay Timer 2	190	01	7C	11	7C
30383	44479	OFF delay Timer 3	191	01	7E	11	7E
30385	44481	OFF delay Timer 4	192	01	80	11	80
30387	44483	No. of cycles Timer 1	193	01	82	11	82
30389	44485	No. of cycles Timer 2	194	01	84	11	84
30391	44487	No. of cycles Timer 3	195	01	86	11	86
30393	44489	No. of cycles Timer 4	196	01	88	11	88

TABELLE 11: 3X and 4X register addresses for 32-bit integer energy

Address (3X Register)	Address (4X Register)	Parameter	Start address Hex 3X		Start address Hex 4X	
			High Byte	Low Byte	High Byte	Low Byte
30769	44865	Energy import channel 1	03	00	13	00
30771	44867	Energy import channel 2	03	02	13	02
30773	44869	Energy import channel 3	03	04	13	04
30775	44871	Energy import channel 4	03	06	13	06
30777	44873	Energy import channel 1 OFF	03	08	13	08
30779	44875	Energy import channel 2 OFF	03	0A	13	0A
30781	44877	Energy import channel 3 OFF	03	0C	13	0C
30783	44879	Energy import channel 4 OFF	03	0E	13	0E
30785	44881	Energy export channel 1	03	10	13	10
30787	44883	Energy export channel 2	03	12	13	12
30789	44885	Energy export channel 3	03	14	13	14

Continuation Table 11: 3X and 4X register addresses for 32-bit integer energy

Address (3X Register)	Address (4X Register)	Parameter	Start address Hex 3X		Start address Hex 4X	
			High Byte	Low Byte	High Byte	Low Byte
30791	44887	Energy export channel 4	03	16	13	16
30793	44889	Energy export channel 1 OFF	03	18	13	18
30795	44891	Energy export channel 2 OFF	03	1A	13	1A
30797	44893	Energy export channel 3 OFF	03	1C	13	1C
30799	44895	Energy export channel 4 OFF	03	1E	13	1E
30801	44897	Total energy import	03	20	13	20
30803	44899	Total energy import OFF	03	22	13	22
30805	44901	Total energy export	03	24	13	24
30807	44903	Total energy export OFF	03	26	13	26
30809	44905	Update rate energy import channel 1 ON*	03	28	13	28
30811	44907	Update rate energy import channel 2 ON*	03	2A	13	2A
30813	44909	Update rate energy import channel 3 ON*	03	2C	13	2C
30815	44911	Update rate energy import channel 4 ON*	03	2E	13	2E
30817	44913	Update rate energy import channel 1 OFF*	03	30	13	30
30819	44915	Update rate energy import channel 2 OFF*	03	32	13	32
30821	44917	Update rate energy import channel 3 OFF*	03	34	13	34
30823	44919	Update rate energy import channel 4 OFF*	03	36	13	36
30825	44921	Update rate energy export channel 1 ON*	03	38	13	38
30827	44923	Update rate energy export channel 2 ON*	03	3A	13	3A
30829	44925	Update rate energy export channel 3 ON*	03	3C	13	3C
30831	44927	Update rate energy export channel 4 ON*	03	3E	13	3E
30833	44929	Update rate energy export channel 1 OFF*	03	40	13	40
30835	44931	Update rate energy export channel 2 OFF*	03	42	13	42
30837	44933	Update rate energy export channel 3 OFF*	03	44	13	44
30839	44935	Update rate energy export channel 4 OFF*	03	46	13	46
30841	44937	Ampere hour import channel 1	03	48	13	48
30843	44939	Ampere hour import channel 2	03	4A	13	4A
30845	44941	Ampere hour import channel 3	03	4C	13	4C
30847	44943	Ampere hour import channel 4	03	4E	13	4E
30849	44945	Ampere hour import channel 1 OFF	03	50	13	50
30851	44947	Ampere hour import channel 2 OFF	03	52	13	52
30853	44949	Ampere hour import channel 3 OFF	03	54	13	54
30855	44951	Ampere hour import channel 4 OFF	03	56	13	56
30857	44953	Ampere hour export channel 1	03	58	13	58
30859	44955	Ampere hour export channel 2	03	5A	13	5A
30861	44957	Ampere hour export channel 3	03	5C	13	5C
30863	44959	Ampere hour export channel 4	03	5E	13	5E
30865	44961	Ampere hour export channel 1 OFF	03	60	13	60
30867	44963	Ampere hour export channel 2 OFF	03	62	13	62
30869	44965	Ampere hour export channel 3 OFF	03	64	13	64
30871	44967	Ampere hour export channel 4 OFF	03	66	13	66
30873	44969	Total ampere hour import	03	68	13	68
30875	44971	Total ampere hour import OFF	03	6A	13	6A
30877	44973	Total ampere hour export	03	6C	13	6C
30879	44975	Total ampere hour export OFF	03	6E	13	6E
30881	44977	On hour	03	70	13	70

Continuation Table 11: 3X and 4X register addresses for 32-bit integer energy

Address (3X Register)	Address (4X Register)	Parameter	Start address Hex 3X		Start address Hex 4X	
			High Byte	Low Byte	High Byte	Low Byte
30883	44979	Run hour channel 1	03	72	13	72
30885	44981	Run hour channel 2	03	74	13	74
30887	44983	Run hour channel 3	03	76	13	76
30889	44985	Run hour channel 4	03	78	13	78
30891	44987	Energy import old channel 1	03	7A	13	7A
30893	44989	Energy import old channel 2	03	7C	13	7C
30895	44991	Energy import old channel 3	03	7E	13	7E
30897	44993	Energy import old channel 4	03	80	13	80
30899	44995	Energy import old channel 1 OFF	03	82	13	82
30901	44997	Energy import old channel 2 OFF	03	84	13	84
30903	44999	Energy import old channel 3 OFF	03	86	13	86
30905	45001	Energy import old channel 4 OFF	03	88	13	88
30907	45003	Energy export old channel 1	03	8A	13	8A
30909	45005	Energy export old channel 2	03	8C	13	8C
30911	45007	Energy export old channel 3	03	8E	13	8E
30913	45009	Energy export old channel 4	03	90	13	90
30915	45011	Energy export old channel 1 OFF	03	92	13	92
30917	45013	Energy export old channel 2 OFF	03	94	13	94
30919	45015	Energy export old channel 3 OFF	03	96	13	96
30921	45017	Energy export old channel 4 OFF	03	98	13	98
30923	45019	Ampere hour import old channel 1	03	9A	13	9A
30925	45021	Ampere hour import old channel 2	03	9C	13	9C
30927	45023	Ampere hour import old channel 3	03	9E	13	9E
30929	45025	Ampere hour import old channel 4	03	A0	13	A0
30931	45027	Ampere hour import old channel 1 OFF	03	A2	13	A2
30933	45029	Ampere hour import old channel 2 OFF	03	A4	13	A4
30935	45031	Ampere hour import old channel 3 OFF	03	A6	13	A6
30937	45033	Ampere hour import old channel 4 OFF	03	A8	13	A8
30939	45035	Ampere hour export old channel 1	03	AA	13	AA
30941	45037	Ampere hour export old channel 2	03	AC	13	AC
30943	45039	Ampere hour export old channel 3	03	AE	13	AE
30945	45041	Ampere hour export old channel 4	03	B0	13	B0
30947	45043	Ampere hour export old channel 1 OFF	03	B2	13	B2
30949	45045	Ampere hour export old channel 2 OFF	03	B4	13	B4
30951	45047	Ampere hour export old channel 3 OFF	03	B6	13	B6
30953	45059	Ampere hour export old channel 4 OFF	03	B8	13	B8
30955	45051	On hour old	03	BA	13	BA
30957	45053	Run hour channel 1 old	03	BC	13	BC
30959	45055	Run hour channel 2 old	03	BE	13	BE
30961	45057	Run hour channel 3 old	03	C0	13	C0
30963	45059	Run hour channel 4 old	03	C2	13	C2

*These values are updated depending on the update rate, and can be changed by the user. For example, if the user set the update rate to 10 minutes, the values on these registers are updated every 10 minutes.

Table 12: 4X-Address register

Address	Parameter	Read / write	Start Address Hex		Default values
			High Byte	Low Byte	
40003	Demand integration time	R/W	00	2	1
40005	Reset parameters (Resetting, see Table 13, page 33)	R/W	00	4	0
40007	RS485 setup code (see Table 14, page 33)	R/W	00	6	4
40009	Mod Address (1...247)	R/W	00	8	1
40027	Nominal voltage (see Table 3, page 14)	R/W	00	1A	48, 110, 1000*
40029	Automatic detection of the nominal voltage	R/WP	00	1C	0
40031	Channel select (e.g. 11111 or 10001, etc.)	R/W	00	1E	11111
40033	Rated nominal current channel 1 (1...2000)	R/W	00	20	5
40035	Rated nominal current channel 2 (1...2000)	R/W	00	22	5
40037	Rated nominal current channel 3 (1...2000)	R/W	00	24	5
40039	Rated nominal current channel 4 (1...2000)	R/W	00	26	5
40041	Current shunt channel 1 (50...150 mV)	R/W	00	28	75
40043	Current shunt channel 2 (50...150 mV)	R/W	00	2A	75
40045	Current shunt channel 3 (50...150 mV)	R/W	00	2C	75
40047	Current shunt channel 4 (50...150 mV)	R/W	00	2E	75
40053	Update rate energy channel 1 (1...60 min)	R/W	00	34	15
40055	Update rate energy channel 2 (1...60 min)	R/W	00	36	15
40057	Update rate energy channel 3 (1...60 min)	R/W	00	38	15
40059	Update rate energy channel 4 (1...60 min)	R/W	00	3A	15
40061	Energy output channel 1 (see table 5, page 15)	R/W	00	3C	2
40063	Energy output channel 2 (see table 5, page 15)	R/W	00	3E	2
40065	Energy output channel 3 (see table 5, page 15)	R/W	00	40	2
40067	Energy output channel 4 (see table 5, page 15)	R/W	00	42	2
40069	Noise current cutoff (0...30)	R/W	00	44	0
40073	Register order	R/Wp	00	48	0
40075	Auto scolling (0=of, 1'065'353'216 = on)	R/W	00	4A	--
40077	Reverse lock channel 1 (see table 4, page 14)**	R/W	00	4C	0
40079	Reverse lock channel 2 (see table 4, page 14)**	R/W	00	4E	0
40081	Reverse lock channel 3 (see table 4, page 14)**	R/W	00	50	0
40083	Reverse lock channel 4 (see table 4, page 14)**	R/W	00	52	0
40085	Reset energy count channel 1 (6, 7 or 8 digits)	R/W	00	54	8
40087	Reset energy count channel 2 (6, 7 or 8 digits)	R/W	00	56	8
40089	Reset energy count channel 3 (6, 7 or 8 digits)	R/W	00	58	8
40091	Reset energy count channel 4 (6, 7 or 8 digits)	R/W	00	5A	8
40093	Factory reset	R/W	00	5C	0
40095	Password	R/W	00	5E	0
40097	Serial-No.	R/WP	00	60	--
40099	Model-No.	R/WP	00	62	600/6002
40101	Firmware version No.	R/WP	00	64	--
40103	User assignable screen ON/OFF (0=off, 1=on)	R/W	00	66	0
40105	User screen 1 (see Table 2, page 11)	R/W	00	68	1
40107	User screen 2 (see Table 2, page 11)	R/W	00	6A	2
40109	User screen 3 (see Table 2, page 11)	R/W	00	6C	3
40111	User screen 4 (see Table 2, page 11)	R/W	00	6E	6
40113	User screen 5 (see Table 2, page 11)	R/W	00	70	7

Continuation Table 12: 4X-Address register

Address	Parameter	Read / write	Start Address Hex		Default values
			High Byte	Low Byte	
40115	User screen 6 (see Table 2, page 11)	R/W	00	72	10
40117	User screen 7 (see Table 2, page 11)	R/W	00	74	11
40119	User screen 8 (see Table 2, page 11)	R/W	00	76	14
40121	User screen 9 (see Table 2, page 11)	R/W	00	78	15
40123	User screen 10 (see Table 2, page 11)	R/W	00	7A	18
40125	Pulse divisor for pulse output 1 (see Table 9, page 18)	R/W	00	7C	1
40127	Pulse divisor for pulse output 2 (see Table 9, page 18)	R/W	00	7E	1
40133	Pulse width for pulse output (60, 100 and 200 ms)	R/W	00	84	100
40219	Select relay output 1 (see chapter 6.5.1, page 15)	R/W	00	DA	0
40221	Parameters for limit value output (For limit relay, see Table 6, page 15) (For pulse relay, see Table 7, page 16) (For timer relay, see Table 16, page 33)	R/W	00	DC	0
40223	Selection Configuration Relay 1 (For limit relay, see Table 15A, page 33) (For timer, see table 15B, page 33)	R/W	00	DE	0
40225	Trip point Limit 1(see table 6, page 15) ($\pm 10 \dots \pm 120\%$) / (10...120%) / (10...9999999)	R/W	00	E0	0
40227	Hysteresis Limit 1(0.5...50)	R/W	00	E2	0
40229	Relay 1 / Energizing delay (0...9999)	R/W	00	E4	0
40231	Relay 1 / De-Energizing delay (0...9999)	R/W	00	E6	0
40233	Select relay output 2 (see chapter 6.5.1, page 15)	R/W	00	E8	0
40235	Parameters for limit value output (For limit relay, see Table 6, page 15) (For pulse relay, see Table 7, page 16) (For timer relay, see Table 16, page 33)	R/W	00	EA	0
40237	Selection Configuration Relay 2 (For limit relay, see Table 15A, page 33) (For timer, see table 15B, page 33)	R/W	00	EC	0
40239	Trip point Limit 2 (see table 6, page 15) ($\pm 10 \dots \pm 120\%$) / (10...120%) / (10...9999999)	R/W	00	EE	0
40241	Hysteresis Limit 1(0.5...50)	R/W	00	F0	0
40243	Relay 2 / Energizing delay (0...9999)	R/W	00	F2	0
40245	Relay 2 / De-Energizing delay (0...9999)	R/W	00	F4	0
40247	Select relay output 3 (see chapter 6.5.1, page 15)	R/W	00	F6	0
40249	Parameters for limit value output (For limit relay, see Table 6, page 15) (For pulse relay, see Table 7, page 16) (For timer relay, see Table 16, page 33)	R/W	00	F8	0
40251	Selection Configuration Relay 3 (For limit relay, see Table 15A, page 33) (For timer, see table 15B, page 33)	R/W	00	FA	0
40253	Trip point Limit 3 (see table 6, page 15) ($\pm 10 \dots \pm 120\%$) / (10...120%) / (10...9999999)	R/W	00	FC	0
40255	Hysteresis Limit 3 (0.5...50)	R/W	00	FE	0
40257	Relay 3 / Energizing delay (0...9999)	R/W	01	0	0
40259	Relay 3 / De-Energizing delay (0...9999)	R/W	01	2	0
40261	Select relay output 4 (see chapter 6.5.1, page 15)	R/W	01	4	0

FContinuation Table 12: 4X-Address register

Address	Parameter	Read / write	Start Address Hex		Default values
			High Byte	Low Byte	
40263	Parameters for limit value output (For limit relay, see Table 6, page 15) (For pulse relay, see Table 7, page 16) (For timer relay, see Table 16, page 33)	R/W	01	6	0
40265	Selection Configuration Relay 4 (For limit relay, see Table 15A, page 33) (For timer, see table 15B, page 33)	R/W	01	8	0
40267	Trip point Limit 4 (see table 6, page 15) ($\pm 10 \dots \pm 120\%$) / (10...120%) / (10...9999999)	R/W	01	0A	0
40269	Hysteresis Limit 4 (0.5...50)	R/W	01	0C	0
40271	Relay 4 / Energizing delay (0...9999)	R/W	01	0E	0
40273	Relay 4 / De-Energizing delay (0...9999)	R/W	01	10	0
40303	Status Relay 1 (0 = OFF / 1 = ON)	R/WP	01	2E	0
40305	Status Relay 2 (0 = OFF / 1 = ON)	R/WP	01	30	0
40307	Status Relay 3 (0 = OFF / 1 = ON)	R/WP	01	32	0
40309	Status Relay 4 (0 = OFF / 1 = ON)	R/WP	01	34	0
40311	Timer 1 Start/Stop (0 = OFF / 1 = ON)	R/W	01	36	0
40313	Timer 2 Start/Stop (0 = OFF / 1 = ON)	R/W	01	38	0
40315	Timer 3 Start/Stop (0 = OFF / 1 = ON)	R/W	01	3A	0
40317	Timer 4 Start/Stop (0 = OFF / 1 = ON)	R/W	01	3C	0
40319	Counterstart energy import Channel 1	R/WP	01	3E	0
40321	Counterstart energy import Channel 2	R/WP	01	40	0
40323	Counterstart energy import Channel 3	R/WP	01	42	0
40235	Counterstart energy import Channel 4	R/WP	01	44	0
40327	Counterstart energy export Channel 1	R/WP	01	46	0
40329	Counterstart energy export Channel 1	R/WP	01	48	0
40331	Counterstart energy export Channel 1	R/WP	01	4A	0
40333	Counterstart energy export Channel 1	R/WP	01	4C	0

* This value differs depending on the measuring range. It is available for 48, 110 & 1000 10, 60 V, 61 ... 200 V & 201 ... 1000 V.

** This is only possible if the corresponding channel is active (see address 4031)

Legende:

WP = Write protected / R = Read only / R/W = Read & Write / R/WP = Read & Write protected

Table 13: Reset Parameter

Parameter No	Parameter
0	None
1	All
2	On hour
3	No of interrupts
4	High vottage

Parameter No	Parameter
5	Low voltage
6XXXX	High current
7XXXX	Low current
8XXXX	Energy
9XXXX	Demand

Parameter No	Parameter
12XXXX	Ampere hour
13XXXX	Run hour
14XXXX	Channel data

For reset parameters, XXXX represents channels 1, 2, 3 & 4. To reset a parameter on a particular channel, write 1 instead of the X otherwise write 0. For example, if a user wants to reset channels 1 and 2, the reset code is 81100..

Table 14: Communication Parameters

Baud Rate	Parity	Stop bit	Decimal value
4800	None	1	0
4800	None	2	1
4800	Even	1	2
4800	Odd	1	3
9600	None	1	4
9600	None	2	5
9600	Even	1	6

Baud Rate	Parity	Stop bit	Decimal value
9600	Odd	1	7
19200	None	1	8
19200	None	2	9
19200	Even	1	10
19200	Odd	1	11
38400	None	1	12
38400	None	2	13

Baud Rate	Parity	Stop bit	Decimal value
38400	Even	1	14
38400	Odd	1	15
57600	None	1	16
57600	None	2	17
57600	Even	1	18
57600	Odd	1	19

Table 15: Relay Configuration**A) For Limit Relay**

Code	Configuration
0	Hi - alarm & energised Relay
1	Hi - alarm & De-energised Relay
2	Lo - alarm & Energised Relay
3	Lo - alarm & De-energised Relay

B) For Timer, Reverse Lock Relay

Code	Configuration
0	Energize when triggered
1	De-energize when triggered

Table 16: Number of Cycles for Timer Relay

Code	Configuration
0	Unlimited
1...9999	Fixed Cycles

10.3 User Assignable Modbus Registers

The SIRAX BM1450 contains 20 user assignable registers in the address range of 0x200 (30513) to 0x226 (30551) for 3X registers (see Table 17) and address range of 0x1E00 (47681) to 0x1E26 (47719) for 4X registers (see Table 18).

Any of the parameter addresses (3X register addresses and 4X register addresses Table 10) accessible in the instrument can be mapped to these 20 user assignable registers.

Parameters (3X and 4X registers addresses) that reside in different locations may be accessed by the single request by re-mapping them to adjacent address in the user assignable registers area.

The actual address of the parameters (3X and 4X registers addresses) which are to be accessed via address 0x200 to 0x226 (or 0x1E00 to 0x1E26) are specified in 4X Register 0x200 to 0x213. (see TABLE 19)

Table 17: User Assignable 3X Data Registers

Address (Register)	Assignable Register	Start Address (ex)	
		High Byte	Low Byte
30513	Assignable Register 1	02	00
30515	Assignable Register 3	02	02
30517	Assignable Register 3	02	04
30519	Assignable Register 4	02	06
30521	Assignable Register 5	02	08
30523	Assignable Register 6	02	0A
30525	Assignable Register 7	02	0C
30527	Assignable Register 8	02	0E
30529	Assignable Register 9	02	10
30531	Assignable Register 10	02	12

Address (Register)	Assignable Register	Start Address (ex)	
		High Byte	Low Byte
30533	Assignable Register 11	02	14
30535	Assignable Register 12	02	16
30537	Assignable Register 13	02	18
30539	Assignable Register 14	02	1A
30541	Assignable Register 15	02	1C
30543	Assignable Register 16	02	1E
30545	Assignable Register 17	02	20
30547	Assignable Register 18	02	22
30549	Assignable Register 19	02	24
30551	Assignable Register 20	02	26

Table 18: User Assignable 4X Data Registers

Address (Register)	Assignable Register	Start Address (ex)	
		High Byte	Low Byte
47681	Assignable Register 1	1E	00
47683	Assignable Register 3	1E	02
47685	Assignable Register 3	1E	04
47687	Assignable Register 4	1E	06
47689	Assignable Register 5	1E	08
47691	Assignable Register 6	1E	0A
47693	Assignable Register 7	1E	0C
47695	Assignable Register 8	1E	0E
47697	Assignable Register 9	1E	10
47699	Assignable Register 10	1E	12

Address (Register)	Assignable Register	Start Address (ex)	
		High Byte	Low Byte
47701	Assignable Register 11	1E	14
47703	Assignable Register 12	1E	16
47705	Assignable Register 13	1E	18
47707	Assignable Register 14	1E	1A
47709	Assignable Register 15	1E	1C
47711	Assignable Register 16	1E	1E
47713	Assignable Register 17	1E	20
47715	Assignable Register 18	1E	22
47717	Assignable Register 19	1E	24
47719	Assignable Register 20	1E	26

TABELLE 19: Benutzerzuweisbare Mapping-Register (4X Register)

Address (Register)	Assignable Register	Start Address (ex)	
		High Byte	Low Byte
40513	Mapped Add Reg #0x0200	02	00
40514	Mapped Add Reg #0x0202	02	01
40515	Mapped Add Reg #0x0204	02	02
40516	Mapped Add Reg #0x0206	02	03
40517	Mapped Add Reg #0x0208	02	04
40518	Mapped Add Reg #0x020A	02	05
40519	Mapped Add Reg #0x020C	02	06
40520	Mapped Add Reg #0x020E	02	07
40521	Mapped Add Reg #0x0210	02	08
40522	Mapped Add Reg #0x0212	02	09

Address (Register)	Assignable Register	Start Address (ex)	
		High Byte	Low Byte
40523	Mapped Add Reg #0x0214	02	0A
40524	Mapped Add Reg #0x0216	02	0B
40525	Mapped Add Reg #0x0218	02	0C
40526	Mapped Add Reg #0x021A	02	0D
40527	Mapped Add Reg #0x021C	02	0E
40528	Mapped Add Reg #0x021E	02	0F
40529	Mapped Add Reg #0x0220	02	10
40530	Mapped Add Reg #0x0202	02	11
40531	Mapped Add Reg #0x0224	02	12
40532	Mapped Add Reg #0x0226	02	13

Assigning parameter to User Assignable Registers

To access the Current Channel 1 (3X address 0x0002) and Power channel 3 (3X address 0x000E) through user assignable register assign these addresses to 4x register (Table 19) 0x0200 and 0x0201 respectively.

Query:

device address	Funktion code	Start address Hi	Start address Lo	No of Register Hi	No of Register Lo	Byte count	i.e. current channel 1 (3X Adresse 0x0002)		i.e. power channel 3 (3X Adresse 0x001E)		CRC Low	CRC High
							Data Reg. 1 High Byte	Data Reg. 1 Low Byte	Data Reg. 2 High Byte	Data Reg. 2 Low Byte		
01 (Hex)	10 (Hex)	02 (Hex)	00 (Hex)	00 (Hex)*	02 (Hex)*	04 (Hex)	00 (Hex)	02 (Hex)	00 (Hex)	0E (Hex)	CA (Hex)	CB (Hex)

* Note: The parameters should be assigned in multiple of two, i.e. 2, 4, 6, 8 20

Response:

device address	Funktion code	Start address Hi	Start address Lo	No of Register Hi	Data bytes	CRC Low	CRC High
01 (Hex)	10 (Hex)	02 (Hex)	00 (Hex)	00 (Hex)	02 (Hex)	40 (Hex)	70 (Hex)

Reading Parameter data through User Assignable Registers:

In assigning query Current channel 1 & Power channel 3 parameters were assigned to 0x 200 & 0x201 (Table 19) which will point to user assignable 3x registers 0x200 and 0x202 (Table 17). So to read Current channel1 and Power channel3 data reading query should be as below.

Query:

device address	Funktion code	Start address Hi	Start address Lo	No of Register Hi	No of Register Lo	CRC Low	CRC High
01 (Hex)	04 (Hex)	02 (Hex)	00 (Hex)	00 (Hex)	04 (Hex)**	F0 (Hex)	71 (Hex)

** Note: Two consecutive 16 bit register represent one parameter. Since two parameters are requested four registers are required.

Response: (Current channel 1 = 219.30 A / Power channel 3 = 1.0 W)

device address	Funktion code	Byte count	i.e. current channel 1				i.e. power channel 3				CRC Low	CRC High
			Data Reg. 1 High Byte	Data Reg. 1 Low Byte	Data Reg. 2 High Byte	Data Reg. 4 Low Byte	Data Reg. 3 High Byte	Data Reg. 3 Low Byte	Data Reg. 4 High Byte	Data Reg. 4 Low Byte		
01 (Hex)	04 (Hex)	08 (Hex)	00 (Hex)	00 (Hex)*	02 (Hex)*	04 (Hex)	3F (Hex)	80 (Hex)	00 (Hex)	00 (Hex)	79 (Hex)	3F (Hex)

To get the data through User Assignable Register go through the following steps::

1. Assign starting addresses (Table 10) of parameters of interest to "User assignable mapping registers" in a sequence in which they are to be accessed (see section "Assigning Parameter to User Assignable Registers").
2. Once the parameters are mapped, data can be acquired by using "User assignable data register" Starting address i.e. to access data of Current channel 1, Power channel 3, Import Demand channel 2 send query with starting address 0x200 with number of register 8 or individually parameters can be accessed. (See section Reading Parameter data through User Assignable Registers).

