

The following symbols in the Operating Instructions indicate safety precautions which must be strictly observed:



The instruments must only be disposed of in the correct way!

Operating Instructions

Programmable isolating amplifier SINEAX TV809



Camille Bauer LTD
Aargauerstrasse 7
CH-5610 Wohlen/Switzerland
Phone +41 56 618 21 11
Fax +41 56 618 35 35
info@camillebauer.com
www.camillebauer.com



TV809 Be 147 802-04 08.12

Contents

1. Read first and then	1
2. Scope of supply	1
3. Brief description	1
4. Overview of the parts	1
5. Technical data	2
6. Mounting	2
7. Electrical connections	2
8. Configuring the isolating amplifier	3
9. Accessories and spare parts	3
10. Commissioning	3
11. Maintenance	3
12. Releasing the isolating amplifier	3
13. Dimensional drawings	4
14. Declaration of conformity	4

Description	Order Code
5. Test records	
Without test records	0
With test records in German	D
With test records in English	E



Fig. 1

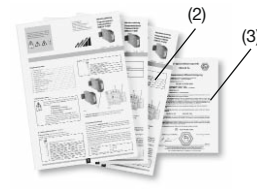

Fig. 2

1 Operating Instructions (2) each in German, French and English
1 Ex approval (3), only for Ex version devices

1. Read first and then ...



The proper and safe operation of the device assumes that the Operating Instructions are **read** and the safety warnings given in the various Sections

6. Mounting
7. Electrical connections
8. Configuring the isolating amplifier
10. Commissioning
are **observed**.

Unauthorized repair or alteration of the unit invalidates the warranty!
The device should only be handled by appropriately trained personnel who are familiar with it and authorised to work in electrical installations.

2. Scope of supply (Fig. 1 and 2)

Isolating amplifier

Order Code: Significance of the 1st to 5th digits

Description	Order Code
1. Mechanical design	809 -
Housing with screw terminals, not pluggable	3
Housing with screw terminals, pluggable	9
2. Version/Power supply	
Standard/Power supply 24 ... 60 V DC, AC	1
Standard/Power supply 85 ... 230 V DC, AC	2
[Ex ia Ga] IIC and [Ex ia Da] IIIC Power supply 24 ... 60 V DC, AC	3
[Ex ia Ga] IIC and [Ex ia Da] IIIC Power supply 85...110 V DC/230 V AC	4
3. Current input rating	
Input current max. final value 100 mA (standard)	1
Input current max. final value 1.5 mA	2
4. Alarm function	
Without alarm function	0
With built-in alarm relay	1

3. Brief description

The purpose of the isolating amplifier **SINEAX TV809** is to electrically insulate input and output signals, respectively to amplify and/or change the signal level or type (current or voltage) of the input signals.

An explosion-proof "intrinsically safe" [Ex ia Ga] IIC and [Ex ia Da] IIIC version rounds off this series of SINEAX TV809.

Measured variables and measuring ranges are programmed with the aid of a PC, a programming cable and the programming software. Specific measured variable data such as output signal, transmission characteristics and various functions in combination with the alarm function can also be programmed.

Isolating amplifier supplied as standard versions are configured as follows:

- Measuring input:	4 ... 20 mA
- Measuring output:	4 ... 20 mA
- Response time:	80 ms
- Mains ripple suppression:	50 Hz

4. Overview of the parts

Figure 3 shows those parts of the device of consequence for electrical connections and other operations described in the Operating Instructions.

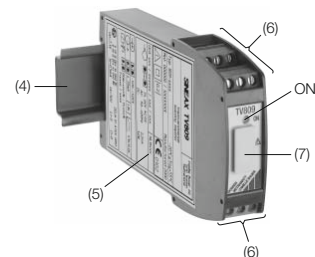

Fig. 3

(4) Top-hat rail 35 × 15 mm or 35 × 7.5 mm (EN 50022)

(5) Type label

(6) Terminals

ON Green LED to indicate the operating state and limit exceeded. The LED flashes (option)

(7) Programming connector

5. Technical data

Measuring input

Input variable and measuring range configured

DC current: Type 809 – xx1
Start value/final value between – 100 and 100 mA, $R_i = 15.4 \Omega$
Any point may be zero
Type 809 – xx2
Start value/final value between – 1.5 and 1.5 mA, $R_i = 1 k\Omega$
Any point may be zero

DC voltage: **Ex version max. 30 V**
 $\pm 1.7 V$, $R_i = 1 M\Omega$
 ± 1.7 to $\pm 100 V$, $R_i = 540 k\Omega$
 ± 100 to $\pm 1000 V$, $R_i = 5.5 M\Omega$
Reduced safety

Measuring output

DC current*: Programmable, reference range – 20 ... 20 mA, start and final values anywhere within the reference range, also with reversed direction, e.g. 20 ... 4 mA

External resistance: $R_{ext} \max. \leq 600 \Omega$ with 20 mA output

DC voltage*: Programmable, reference range – 10 ... 10 V, start and final values anywhere within the reference range, also with reversed direction, e.g. + 10 ... – 5 V

Load capacity: $R_{ext} \min. \geq 1000 \Omega$ with 10 V output

Programming connector on isolating amplifier

Interface: Serial interface

Power supply

DC, AC power pack (DC or 50...400 Hz)

Rated voltages and permissible variations

Nominal voltage U_N	Tolerance	Instruments version
24 ... 60 V DC, AC	DC – 15 ... + 33% AC $\pm 15\%$	Standard (Non-Ex)
85 ... 230 V** DC, AC		
24 ... 60 V DC, AC	DC – 15 ... + 33% AC $\pm 15\%$	Type of protection "Intrinsic safety" [Ex ia Ga] IIC [Ex ia Da] IIIC
85 ... 230 V AC		
85 ... 110 V DC	– 15 ... + 10%	

Power consumption: 1.2 W resp. 2.5 VA

Light emitting diodes

Green LED: Light after switching on the power supply

Output contact (Option)

Relay: For monitoring the measured value limit
1 galvanically isolated switching contact

Contact rating: AC: 2 A / 250 V (500 VA)
DC: 2 A / 125 V (60 W)

Material: Gold flashed silver alloy

Trip point type: Programmable as low or high trip point

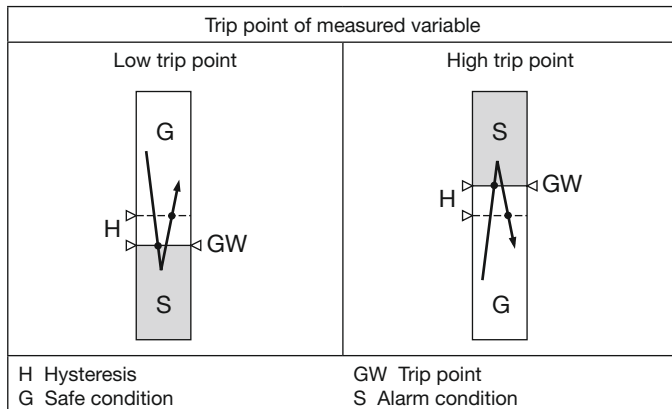



Fig. 4. Switching function, according to trip point type.

Trip point adjustment
with PC for trip point: Programmable between – 10 and 110%***
Hysteresis: Programmable between > 0 and 100%***
Energizing and de-energizing delays: Programmable between 0 to 1080 s
Relay contact position: Programmable
Frontplate signals: The green LED "ON" flashes when the limit value is exceeded

Intrinsically safe

Type examination certificate: ZELM 01 ATEX 0051 and 1st supplement
Identification:  II (1) G [Ex ia Ga] IIC
 II (1) D [Ex ia Da] IIIC

6. Mounting

The SINEAX TV809 can be mounted on a top-hat rail.



When deciding where to install the isolating amplifier (measuring location), take care that the **limits** of the operating temperature **are kept**:
– 25 and + 55 °C

Simply clip the device onto the top-hat rail (EN 50022) (see Fig. 5).

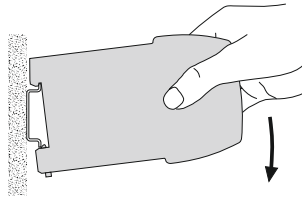

Fig. 5. Mounting onto top-hat rail 35 × 15 or 35 × 7.5 mm.

7. Electrical connections



The connections for the leads are fixed or plug-in screw terminals, depending on the device execution. These are easily accessible at the front of the isolating amplifier and are suitable for a wire cross-section of max. 2.5 mm².



Make sure that the cables are not live when making the connections!
Impending danger by high input voltage or high power supply voltage, 250 V at contact output.



Also note that, ...

... the data required to carry out the prescribed measurement must correspond to those marked on the nameplate of SINEAX TV809 ( measuring input,  measuring output and  power supply)!

... the resistance in the output circuit may not **overrange** the current output value

$$R_{ext} \max. [k\Omega] = \frac{12 V}{I_{AN} [mA]}$$

(I_{AN} = current output value)

and not **underrange** the voltage output value

$$R_{ext} \min. [k\Omega] \geq \frac{U_{AN} [V]}{10 mA}$$

(U_{AN} = voltage output value)

... the measurement input and output cables should be twisted pairs and run as far as possible away from heavy current cables!

In all other respects, observe all local regulations when selecting the type of electrical cable and installing them!



In the case of "Intrinsically safe" explosion-proof, the supplementary information given on the type examination certifications, the EN 60079-14 and also local regulations applicable to electrical installation in explosion hazard areas must be taken into account.

* The type of output variable (current or voltage) is configurable with software

** An external supply fuse must be provided for DC supply voltages > 125 V

*** In relation to the analog output value range

Meas. mode/application	DC voltage			DC current	
Measuring range limits	$\pm 1.7 \text{ V}$	$\pm 1.7 \text{ to } \leq \pm 100 \text{ V}$	$\pm 100 \text{ to } \pm 1000 \text{ V}$	$\pm 100 \text{ mA}$	$\pm 1.5 \text{ mA}$
= Measuring input					
= Meas. output K = Contact output (option) = Power supply					

8. Configuring the isolating amplifier

A PC, the programming cable PRKAB 600 (for Ex instruments) resp. PRKAB 560 (for non-Ex instruments) plus ancillary cable and the configuration software TV 800 *plus* are required to program the isolating amplifier.

The connections between "PC ↔ PRKAB 600 resp. 560 ↔ SINEAX TV809" can be seen from Fig. 6. The power supply must be connected in order to configure the SINEAX TV809.

The software TV 800 *plus* is supplied on a CD and runs under Windows 95 or higher.

The menu driven configuration software explains how to configure the TV809 and the choice of parameters.

The programming cable PRKAB 600 resp. PRKAB 560 adapts the signal level and provides galvanic isolation between the PC and the SINEAX TV809 isolating amplifier.

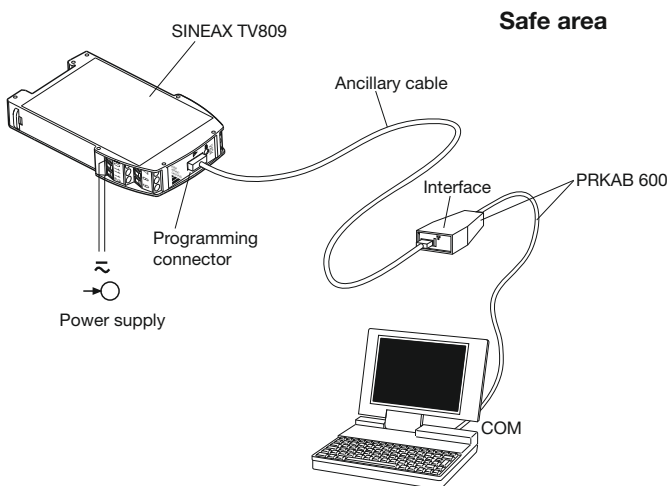
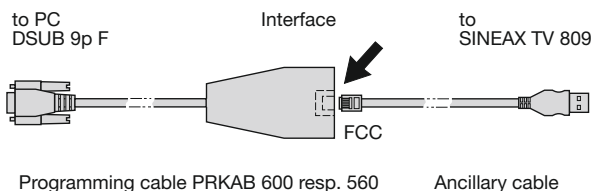

Fig. 6. Configuring a SINEAX TV809, Ex version.



- The programming connector must not be connected when $> 253 \text{ V}$ could be applied to the SINEAX TV809 input circuit.
- The SINEAX TV809 programming connector must only be used with the PRKAB 600 resp 560 and its ancillary cable.
- The ancillary cable must first be connected to the PRKAB 600 resp. 560 before it is connected to the TV809 (see arrow).
- The programming connector is galvanically connected to the input circuit. Therefore no metal parts of the plug or socket may be touched.
- The PRKAB 600 resp. 560 must not be used with other devices.
- After programming is complete, the programming connection must be removed from the TV809.



9. Accessories and spare parts

Description	Order No.
Programming cable PRKAB 560 (for programming the SINEAX TV809, non Ex)	147 779
Programming cable PRKAB 600 (for programming the SINEAX TV809, Ex)	147 787
Ancillary cable SINEAX type TV809	143 587
Configuration software TV800plus for SINEAX TV809 Windows 95 or higher on CD, in different languages (Download free of charge under http://www.camillebauer.com) In addition, the CD contains all configuration programmes presently available for Camille Bauer products	146 557
Operating Instructions TV809 Bd in German	147 422
Operating Instructions TV809 Bf in French	147 795
Operating Instructions TV809 Be in English	147 802

10. Commissioning

Switch on the measuring input and the power supply.



The power supply unit must be capable of supplying a brief current surge when switching on. The isolating amplifier presents a low impedance at the instant of switching which requires a current I_{start} of ...

... $I_{\text{start}} \approx 160 \text{ mA}$ for the version with a power supply range of 24 – 60 V DC, AC

or

... $I_{\text{start}} \approx 35 \text{ mA}$ for the version with a power supply range of 85 – 230 V DC, AC

11. Maintenance

No maintenance is required.

12. Releasing the isolating amplifier

Release the instrument from a top-hat rail as shown in Fig. 7.

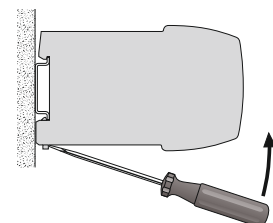

Fig. 7

13. Dimensional drawings

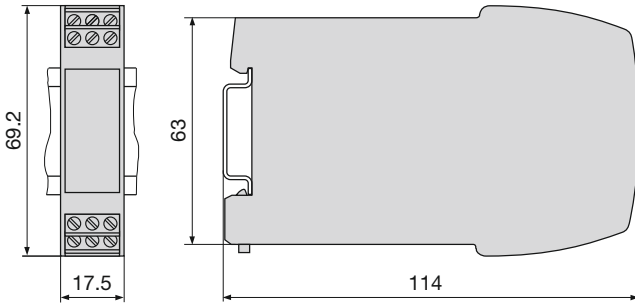

Fig. 8. SINEAX TV809 in carrying rail housing **P12/17** clipped onto a top-hat rail (35 × 15 mm or 35 × 7.5 mm, acc. to EN 50022), **screw terminals not pluggable**.

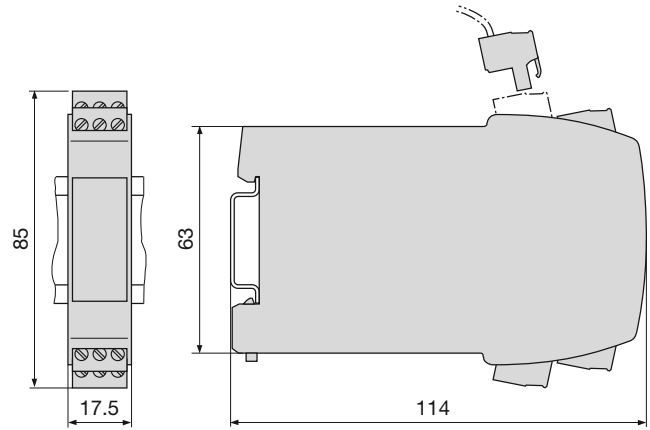





Fig. 9. SINEAX TV809 in carrying rail housing **P12/17 St** clipped onto a top-hat rail (35 × 15 mm or 35 × 7.5 mm, acc. to EN 50022), **screw terminals pluggable**.

14. Declaration of conformity

 EG - KONFORMITÄTSERKLÄRUNG  CAMILLE BAUER EC DECLARATION OF CONFORMITY	
Dokument-Nr./ Document.No.:	TV809_CE-konf.DOC
Hersteller/ Manufacturer:	Camille Bauer AG Switzerland
Anschrift / Address:	Aargauerstrasse 7 CH-5610 Wohlen
Produktbezeichnung/ Product name:	1 Kanalig Programmierbar Trennverstärker Unipolar / Bipolar 1 channel Programmable Isolating amplifier unipolar / bipolar
Typ / Type:	Sineax TV809
<p>Das bezeichnete Produkt stimmt mit den Vorschriften folgender Europäischer Richtlinien überein, nachgewiesen durch die Einhaltung folgender Normen: The above mentioned product has been manufactured according to the regulations of the following European directives proven through compliance with the following standards:</p>	
Richtlinie / Directive	2004/108/EG(CE) Elektromagnetische Verträglichkeit - EMV-Richtlinie Electromagnetic compatibility - EMC directive
Norm / Standard	EN 61000-6-4: 2007 Fachgrundnormen - Störaussendung für Industriebereiche Generic standards - Emission standard for industrial environments EN 61000-6-2: 2005 Fachgrundnormen - Störfestigkeit für Industriebereiche Generic standards - Immunity for industrial environments
Prüfungen / Tests	IEC 61000-4-2 IEC 61000-4-3 IEC 61000-4-4 IEC 61000-4-5 IEC 61000-4-6 IEC 61000-4-11 EN 55011
Richtlinie / Directive	2006/95/EG(CE) Elektrische Betriebsmittel zur Verwendung innerhalb bestimmter Spannungsgrenzen – Niederspannungsrichtlinie – CE-Kennzeichnung : 95 Electrical equipment for use within certain voltage limits – Low Voltage Directive – Attachment of CE marking : 95
Norm / Standard	EN 61010-1: 2001 Sicherheitsbestimmungen für elektrische Mess-, Steuer-, Regel- und Laborgeräte – Teil 1: Allgemeine Anforderungen Safety requirements for electrical equipment for measurement, control and laboratory use – Part 1: General requirements
<p>Die explosionsgeschützte Ausführung stimmt mit folgender Richtlinie überein: The explosion protected variant accords to the following directive:</p>	
Richtlinie / Directive	94/9/EG(CE) Geräte und Schutzsysteme zur bestimmungsgemäßen Verwendung in explosionsgefährdeten Bereichen Equipment and protective systems intended for use in potentially explosive atmospheres
Norm / Standard	EN 60079-0: 2009 / -11: 2012 / -26:2007 Explosionsfähige Atmosphäre / Explosive atmospheres – - 0: Geräte - Allgemeine Anforderungen / General requirements - 11: Geräteschutz durch Eigensicherheit "i" / Equipment protection by intrinsic safety "i" - 26: Betriebsmittel mit Geräteschutzniveau (EPL) Ga / Equipment with equipment protection level (EPL) Ga
Nachweis / Proof	ZELM 01 ATEX 0051 Notified Body No. 0102: PTB D-38116 Braunschweig,
Ort, Datum / Place, date:	Wohlen, 23. Juli 2012
Unterschrift / signature:	
	
M. Ulrich	J. Brem