

Device handbook

CENTRAX CU3000 / CU5000

Operating Instructions CENTRAX CU3000 / CU5000 (2021-11)



GMC INSTRUMENTS

Camille Bauer Metrawatt AG
Aargauerstrasse 7
CH-5610 Wohlen / Switzerland

Phone: +41 56 618 21 11
Telefax: +41 56 618 35 35

E-Mail: info@cbmag.com
<https://www.camillebauer.com>

 CAMILLE BAUER

Legal information

Warning notices

In this document warning notices are used, which you have to observe to ensure personal safety and to prevent damage to property. Depending on the degree of danger the following symbols are used:



If the warning notice is not followed death or severe personal injury **will** result.



If the warning notice is not followed damage to property or severe personal injury **may** result.



If the warning notice is not followed the device **may** be damaged or **may** not fulfill the expected functionality.

Qualified personnel

The product described in this document may be handled by personnel only, which is qualified for the respective task. Qualified personnel have the training and experience to identify risks and potential hazards when working with the product. Qualified personnel are also able to understand and follow the given safety and warning notices.

Intended use

The product described in this document may be used only for the application specified. The maximum electrical supply data and ambient conditions specified in the technical data section must be adhered. For the perfect and safe operation of the device proper transport and storage as well as professional assembly, installation, handling and maintenance are required.

Disclaimer of liability

The content of this document has been reviewed to ensure correctness. Nevertheless it may contain errors or inconsistencies and we cannot guarantee completeness and correctness. This is especially true for different language versions of this document. This document is regularly reviewed and updated. Necessary corrections will be included in subsequent version and are available via our webpage <https://www.camillebauer.com>.

Feedback

If you detect errors in this document or if there is necessary information missing, please inform us via e-mail to: customer-support@camillebauer.com

Contents

| | |
|--|-----------|
| 1. Introduction | 5 |
| 1.1 Purpose of this document | 5 |
| 1.2 Scope of supply | 5 |
| 1.3 Further documents | 5 |
| 2. Safety notes | 6 |
| 3. Device overview | 6 |
| 3.1 Brief description | 6 |
| 3.2 Available measurement data | 7 |
| 4. Mechanical mounting | 8 |
| 4.1 CENTRAX CU3000 | 8 |
| 4.2 CENTRAX CU5000 | 9 |
| 5. Electrical connections | 10 |
| 5.1 General safety notes | 10 |
| 5.2 Terminal assignments of the I/O extensions | 11 |
| 5.2.1 CENTRAX CU3000 | 11 |
| 5.2.2 CENTRAX CU5000 | 12 |
| 5.3 Possible cross sections and tightening torques | 12 |
| 5.4 Inputs | 13 |
| 5.5 Power supply | 25 |
| 5.6 Relays | 25 |
| 5.7 Digital inputs | 25 |
| 5.8 Digital outputs | 26 |
| 5.9 Analog outputs | 27 |
| 5.10 Fault current detection | 28 |
| 5.11 Temperature inputs | 30 |
| 5.12 Modbus interface RS485 | 31 |
| 5.13 Uninterruptible power supply (UPS) | 31 |
| 5.14 GPS time synchronization | 32 |
| 6. Commissioning | 34 |
| 6.1 Parametrization of the device functionality | 35 |
| 6.2 Operating LED (CU5000 only) | 35 |
| 6.3 Installation check | 35 |
| 6.4 Ethernet installation | 37 |
| 6.4.1 Settings | 37 |
| 6.4.2 Connection of the standard interface | 39 |
| 6.4.3 Connection of the IEC61850 interface | 40 |
| 6.4.4 MAC addresses | 41 |
| 6.4.5 Communication tests | 41 |
| 6.4.6 Resetting the communication settings of the CU5000 | 41 |
| 6.5 IEC 61850 interface | 42 |
| 6.6 Security system | 42 |
| 6.6.1 RBAC management | 42 |
| 6.6.2 User log in / out via website | 46 |
| 6.6.3 User log in / out via local display | 47 |
| 6.6.4 Whitelisting clients | 48 |
| 6.6.5 Secure communication using https | 48 |
| 6.6.6 Audit log (SYSLOG) | 49 |
| 7. Operating the device | 51 |
| 7.1 Operating elements | 51 |
| 7.2 Selecting the information to display | 51 |
| 7.3 Measurement displays and used symbols | 52 |
| 7.4 Resetting measurement data | 54 |
| 7.5 Configuration | 54 |
| 7.5.1 Configuration at the device | 54 |
| 7.5.2 Configuration via web browser | 56 |
| 7.6 Monitoring and alarming | 58 |
| 7.6.1 Monitoring fault-currents | 58 |
| 7.6.2 Temperature monitoring | 59 |
| 7.6.3 Summary alarm | 60 |
| 7.7 Data recording | 61 |
| 7.7.1 Periodical data | 61 |
| 7.7.2 User-defined events | 64 |

| | | |
|--------------------|--|------------|
| 7.7.3 | Disturbance recorder | 65 |
| 7.7.4 | Micro SD card (CU3000 only) | 67 |
| 7.8 | Measurement information in file format | 68 |
| 7.8.1 | Creating periodic file data | 68 |
| 7.8.2 | Accessing file information via webpage | 69 |
| 7.8.3 | Periodical sending to a SFTP Server | 70 |
| 7.9 | Timeouts | 70 |
| 8. | CODESYS Quick Start | 71 |
| 8.1 | CODESYS development environment | 71 |
| 8.2 | CENTRAX device description | 71 |
| 8.3 | Create a project | 72 |
| 8.4 | CU3000/CU5000 Device tree | 73 |
| 8.5 | Selection of the I/O extension modules | 73 |
| 8.6 | Using the Modbus master functionality | 74 |
| 8.7 | Creating the CODESYS application | 78 |
| 8.7.1 | Using remanent variables | 78 |
| 8.7.2 | Using the data logger | 78 |
| 8.8 | Creating own visualizations | 80 |
| 8.8.1 | Adding a visualization to the project | 80 |
| 8.8.2 | Target visualization (TargetVisu) | 80 |
| 8.8.3 | WEB visualizations (WebVisu) | 81 |
| 8.9 | Establishing a connection to the device | 82 |
| 8.10 | Loading the application to the device | 83 |
| 8.11 | Loading the application on-site | 86 |
| 8.11.1 | Creating a boot application | 86 |
| 8.11.2 | Deleting the active application | 86 |
| 8.11.3 | Loading the application | 86 |
| 8.11.4 | Starting the application | 87 |
| 8.11.5 | Resetting the active application | 87 |
| 8.12 | Reset | 88 |
| 8.13 | Project management | 89 |
| 8.14 | Services | 89 |
| 8.13 | Example projects | 89 |
| 9. | Service, maintenance and disposal | 90 |
| 9.1 | Calibration and new adjustment | 90 |
| 9.2 | Cleaning | 90 |
| 9.3 | Battery | 90 |
| 9.4 | Disposal | 90 |
| 10. | Technical data | 91 |
| 11. | Dimensional drawings | 98 |
| Annex | 99 | |
| A | Description of measured quantities | 99 |
| A1 | Basic measurements | 99 |
| A2 | Harmonic analysis | 103 |
| A3 | System imbalance | 104 |
| A4 | Mean values and trend | 105 |
| A5 | Meters | 106 |
| B | Display matrices | 107 |
| B0 | Used abbreviations for the measurements | 107 |
| B1 | Display matrices for single phase system | 112 |
| B2 | Display matrices for split-phase (two-phase) systems | 113 |
| B3 | Display matrices for 3-wire system, balanced load | 114 |
| B4 | Display matrices for 3-wire system, balanced load, phase shift | 115 |
| B5 | Display matrices for 3-wire systems, unbalanced load | 116 |
| B6 | Display matrices for 3-wire systems, unbalanced load, Aron | 117 |
| B7 | Display matrices for 4-wire system, balanced load | 118 |
| B8 | Display matrices for 4-wire systems, unbalanced load | 119 |
| B9 | Display matrices for 4-wire system, unbalanced load, Open-Y | 120 |
| C | Logic functions | 121 |
| D | FCC statement | 122 |
| INDEX | 123 | |

1. Introduction

1.1 Purpose of this document

This document describes the universal measurement device for heavy-current quantities CENTRAX CU3000 / CU5000. It is intended to be used by:

- Installation personnel and commissioning engineers
- Service and maintenance personnel
- Planners

Scope

This handbook is valid for all hardware versions of the CU3000 / CU5000. Some of the functions described in this document are available only, if the necessary optional components are included in the device.

Required knowledge

A general knowledge in the field of electrical engineering is required. For assembly and installation of the device knowledge of applicable national safety regulations and installation standard is required.

1.2 Scope of supply



- Measurement device
- Safety instructions (multiple languages)
- Mounting set: 2 mounting clamps (CU3000 only)
- Battery pack (optional, for devices with UPS only)

1.3 Further documents

The following documents are provided electronically via <https://www.camillebauer.com/cu3000-en> or <https://www.camillebauer.com/cu5000-en> :

- Safety instructions
- Data sheet
- Modbus basics: General description of the communication protocol
- Modbus interface CENTRAX CUx000: Register description of Modbus RTU/TCP communication
- IEC61850 interface SINEAX AMx000/DM5000, LINAX PQx000, CENTRAX CUx000
- Camille Bauer certificate for encrypted HTTPS communication

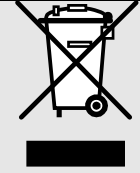
2. Safety notes



Device may only be disposed in a professional manner!

The installation and commissioning should only be carried out by trained personnel.

Check the following points before commissioning:

- that the maximum values for all the connections are not exceeded, see "Technical data" section,
- that the connection wires are not damaged, and that they are not live during wiring,
- that the power flow direction and the phase rotation are correct.

The instrument must be taken out of service if safe operation is no longer possible (e.g. visible damage). In this case, all the connections must be switched off. The instrument must be returned to the factory or to an authorized service dealer.

It is forbidden to open the housing and to make modifications to the instrument. The instrument is not equipped with an integrated circuit breaker. During installation check that a labeled switch is installed and that it can easily be reached by the operators.

Unauthorized repair or alteration of the unit invalidates the warranty.

3. Device overview

3.1 Brief description

The CENTRAX CU3000 / CU5000 combines the functionality of a highly accurate instrument for heavy current applications with the possibilities of a freely programmable PLC in one housing. This makes the need of a separate control, a control system, a remote display or an additional data collector superfluous.

The measuring part of the instrument determines more than 1500 high-quality items of status, energy consumption and power quality. The control application is based on CODESYS and can now, depending on the application, process this data logically, use it in control algorithms or interact with energy generation or consumers as the situation demands.

The instrument can communicate with the process environment via freely selectable I/Os and Modbus interfaces. The ADVANCED and PROFESSIONAL versions offer the additional possibility of importing measured data of other field instruments into the control application via Modbus interfaces for further processing. The nameplates on the device give further details about the present version.

The CENTRAX CU3000 / CU5000 can thus be used for autarkic solutions in the areas of energy management, control and optimisation of the energy consumption, utility monitoring and other general automation and control tasks. A connection to higher-ranking systems is possible at any time.

A comprehensive security concept protects the devices from unauthorized access, eavesdropping of communication or data manipulations. Implemented security mechanisms are Role-Based Access Control (RBAC), encrypted data transmission via HTTPS, logging of all activities in an Audit log with Syslog protocol support, a client whitelist for limiting computers with access authorization and digitally signed firmware files for secure updates.

3.2 Available measurement data

| MEASURED VALUE GROUP | APPLICATION |
|--|---|
| INSTANTANEOUS VALUES U, I, IMS, P, Q, S, PF, LF, QF ... Angle between voltage phasors Min/max of instantaneous values with time stamp | Transparent monitoring of present system state Fault detection, connection check, sense of rotation check Determination of grid variable variance with time reference |
| EXTENDED REACTIVE POWER ANALYSIS Total reactive power, fundamental frequency, harmonics $\cos\phi$, $\tan\phi$ of fundamental frequency with min values in all quadrants | Reactive power compensation Verification of specified power factor |
| HARMONICS ANALYSIS (ACCORDING TO EN 61 000-4-7) Total harmonics content THD U/I and TDD I Individual harmonics U/I up to 50 th | Evaluation of the thermic load of equipment Analysis of system perturbation and consumer structure |
| IMBALANCE ANALYSIS Symmetrical components (positive, negative, zero sequence system) Imbalance (from symmetrical components) Deviation from U/I mean value | Equipment overload protection Fault/earth contact detection |
| ENERGY BALANCE ANALYSIS Meters for the demand/supply of active/reactive power, high/low tariff, meters with selectable fundamental variable Power mean values active/reactive power, demand and supply, freely definable mean values (e.g. phase power, voltage, current and much more). Mean value trends | Preparation of (internal) energy billing Determination of energy consumption versus time (load profile) for energy management or energy efficiency verification Energy consumption trend analysis for load management |
| OPERATING HOURS Operating hours of the device | |

The device provides measurements in the following subcategories:

- a) **Instantaneous values:** Present TRMS values and associated min/max values
- b) **Energy:** Power mean-values with trend and history as well as energy meters. With the data logger option "periodic data" mean-value progressions (load profiles) and periodic meter readings are available as well.
- c) **Harmonics:** Total harmonic distortion THD/TDD, individual harmonics and their maximum values
- d) **Phasor diagram:** Overview of all current and voltage phasors and phase sequence check
- e) **Waveform** of current and voltage inputs
- f) **Events:** Disturbance recordings if the corresponding option is implemented.
- g) **CODESYS:** For devices with performance class PROFESSIONAL measurement progressions or state messages stored via [Codesys application](#) can be requested here. Also access to user-defined [websites](#) is possible via this menu.

4. Mechanical mounting



Please ensure that the [operating temperature limits](#) are not exceeded when determining the place of mounting (place of measurement).



By installing, the device becomes part of an electrical power installation that must be designed, operated and maintained in accordance with country-specific regulations so that the installation is safe and provides prevention against fire and explosion as far as possible.



It is the task of this installation to ensure that dangerous connections of the device can not be touched during operation and that the spread of flames, heat and smoke from the interior is prevented. This may be done by providing an enclosure (e.g. case, cabinet) or using a room accessible to qualified personal only and compliant with local fire safety standards.

4.1 CENTRAX CU3000

► The CU3000 is designed for panel mounting

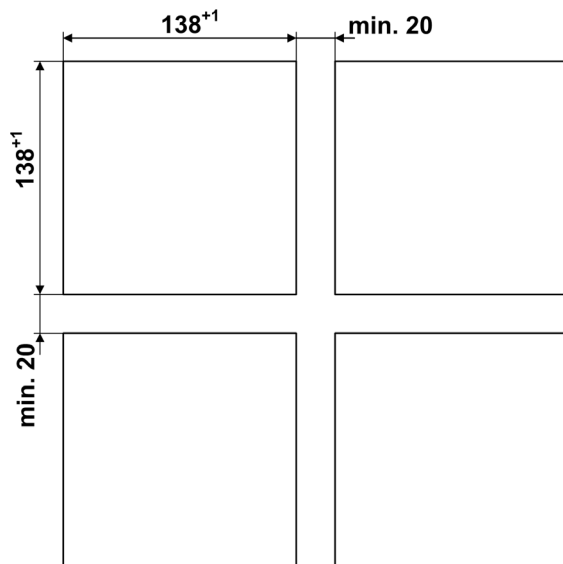

Dimensional drawing CU3000: [See section 11](#)

Panel cutout CU3000

Mounting of the device

The device is suitable for panel widths up to 8mm.

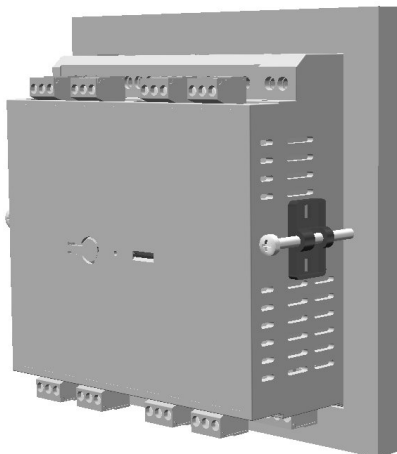

- Slide the device into the cutout from the outside. Orientation as shown.
- From the side slide in the mounting clamps into the intended openings and pull them back about 2 mm
- Tighten the fixation screws until the device is tightly fixed with the panel

Demounting of the device

The demounting of the device may be performed only if all connected wires are out of service. Remove all plug-in terminals and all connections of the current and voltage inputs. Pay attention to the fact, that current transformers must be shorten before removing the current connections to the device. Then demount the device in the opposite order of mounting.

4.2 CENTRAX CU5000

The device can be clipped onto a top-hat rail according to EN 60715. Orientation as shown.

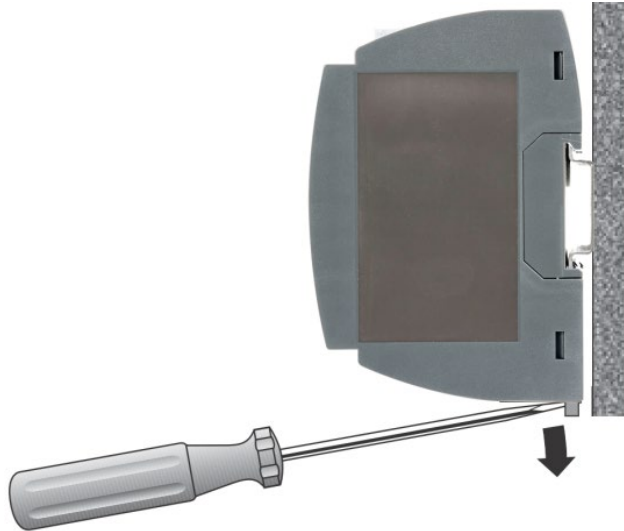

Dimensional drawing CU5000: [See section 11](#)

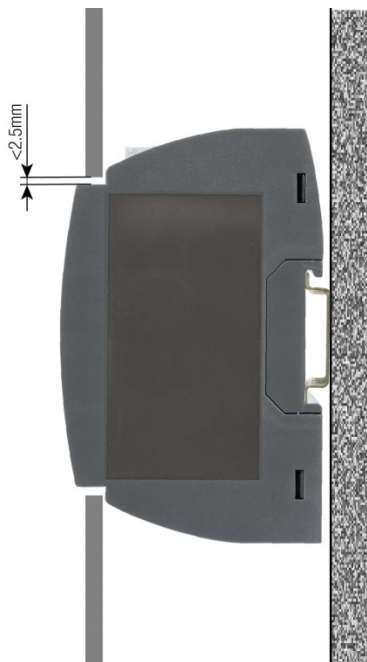

The device can also be mounted that the front of the device protrudes through a cut-out in the enclosure. So the operating buttons and the display become accessible. With centric mounting using the below maximum cut-out a gap between enclosure and device results, which does not exceed 2.5mm on each side.

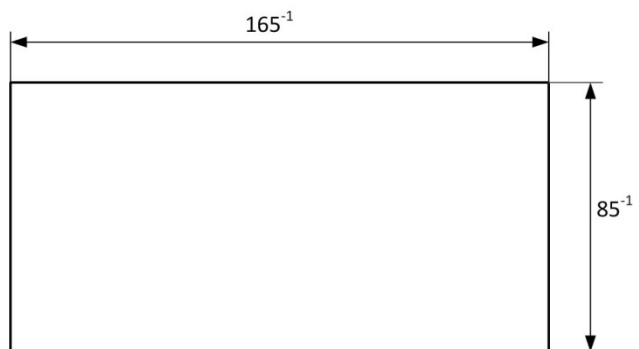

5. Electrical connections



Ensure under all circumstances that the leads are free of potential when connecting them!

5.1 General safety notes



Please observe that the data on the type plate must be adhered to!

The national provisions have to be observed in the installation and material selection of electric lines, e.g. in Germany VDE 0100 "Erection of power installations with nominal voltages up to 1000 V"!

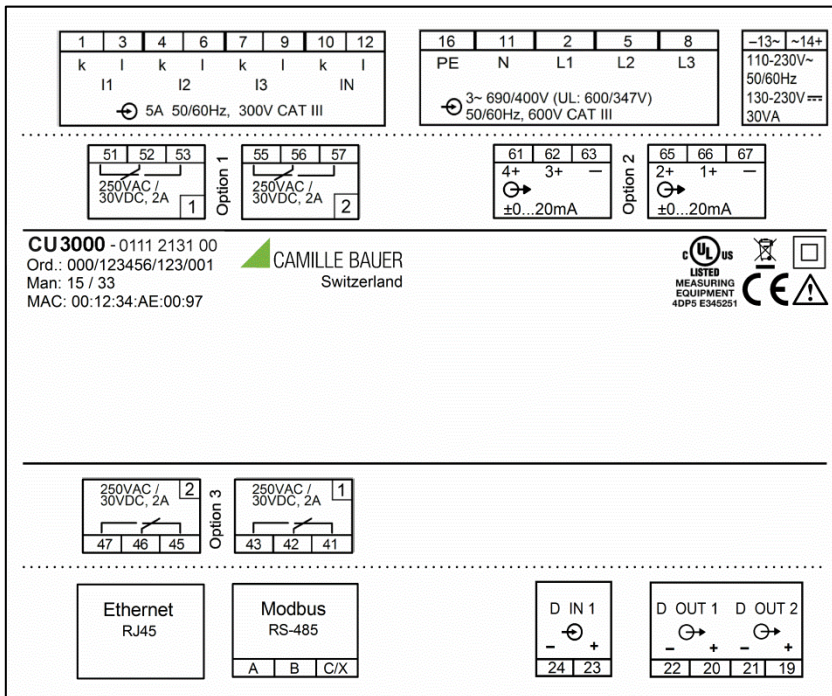

Nameplate of a CU3000 with

- Ethernet interface
- Modbus/RTU interface
- 4 relay outputs
- 4 analog outputs

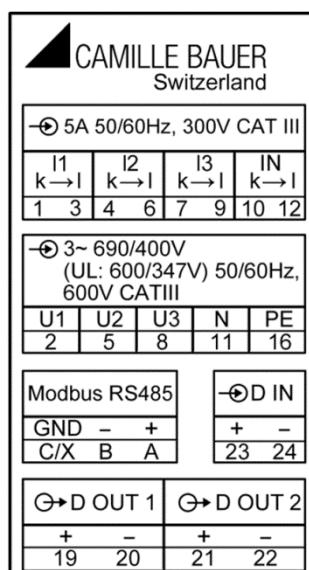
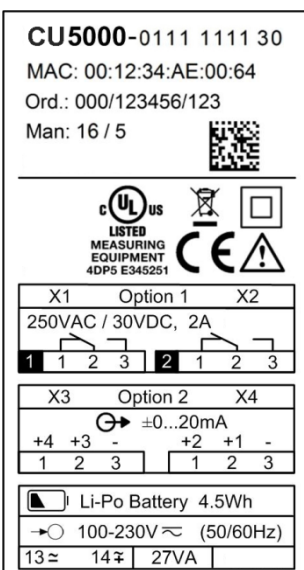

Nameplate of a CU5000 with

- TFT display
- Ethernet interface
- Modbus/RTU interface
- 2 relay outputs
- 4 analog outputs
- UPS

| Symbol | Meaning |
|---------|---|
| | Device may only be disposed of in a professional manner! |
| | Double insulation, device of protection class 2 |
| | CE conformity mark. The device fulfills the requirements of the applicable EU directives. |
| | Products with this mark comply with both the Canadian (CSA) and the American (UL) requirements. |
| | Caution! General hazard point. Read the operating instructions. |
| | General symbol: Power supply |
| | General symbol: Input |
| | General symbol: Output |
| CAT III | Measurement category CAT III |

5.2 Terminal assignments of the I/O extensions

5.2.1 CENTRAX CU3000

| Function | Option 1 | Option 2 | Option 3 | Option 4 |
|----------------------------|--|--|--|--|
| 2 relay outputs | 1.1: 51,52,53 1.2: 55,56,57 | 2.1: 61,62,63 2.2: 65,66,67 | | 4.1: 31,32,33 4.2: 35,36,37 |
| 2 analog outputs | 1.1: 56(+), 57(-) 1.2: 55(+), 57(-) | 2.1: 66(+), 67(-) 2.2: 65(+), 67(-) | 3.1: 46(+), 47(-) 3.2: 45(+), 47(-) | 4.1: 36(+), 37(-) 4.2: 35(+), 37(-) |
| 4 analog outputs | 1.1: 56(+), 57(-) 1.2: 55(+), 57(-) 1.3: 52(+), 53(-) 1.4: 51(+), 53(-) | 2.1: 66(+), 67(-) 2.2: 65(+), 67(-) 2.3: 62(+), 63(-) 2.4: 61(+), 63(-) | 3.1: 46(+), 47(-) 3.2: 45(+), 47(-) 3.3: 42(+), 43(-) 3.4: 41(+), 43(-) | 4.1: 36(+), 37(-) 4.2: 35(+), 37(-) 4.3: 32(+), 33(-) 4.4: 31(+), 33(-) |
| 4 digital inputs (active) | 1.1: 51(-), 53(+) 1.2: 52(-), 53(+) 1.3: 55(-), 57(+) 1.4: 56(-), 57(+) | 2.1: 61(-), 63(+) 2.2: 62(-), 63(+) 2.3: 65(-), 67(+) 2.4: 66(-), 67(+) | 3.1: 41(-), 43(+) 3.2: 42(-), 43(+) 3.3: 45(-), 47(+) 3.4: 46(-), 47(+) | 4.1: 31(-), 33(+) 4.2: 32(-), 33(+) 4.3: 35(-), 37(+) 4.4: 36(-), 37(+) |
| 4 digital inputs (passive) | 1.1: 51(+), 53(-) 1.2: 52(+), 53(-) 1.3: 55(+), 57(-) 1.4: 56(+), 57(-) | 2.1: 61(+), 63(-) 2.2: 62(+), 63(-) 2.3: 65(+), 67(-) 2.4: 66(+), 67(-) | 3.1: 41(+), 43(-) 3.2: 42(+), 43(-) 3.3: 45(+), 47(-) 3.4: 46(+), 47(-) | 4.1: 31(+), 33(-) 4.2: 32(+), 33(-) 4.3: 35(+), 37(-) 4.4: 36(+), 37(-) |
| 2 temperature inputs | 1.1: 52,53 1.2: 56,57 | 2.1: 62,63 2.2: 66,67 | 3.1: 42,43 3.2: 46,47 | 4.1: 32,33 4.2: 36,37 |

5.2.2 CENTRAX CU5000

| Function | Option 1 | Option 2 |
|----------------------------|--|--|
| 2 relay outputs | 1.1: X1.1 / X1.2 / X1.3 1.2: X2.1 / X2.2 / X2.3 | 2.1: X3.1 / X3.2 / X3.3 2.2: X4.1 / X4.2 / X4.3 |
| 2 analog outputs | 1.1: X2.2(+) / X2. 3(-) 1.2: X2.1(+) / X2. 3(-) | 2.1: X4.2(+) / X4.3 (-) 2.2: X4.1(+) / X4.3 (-) |
| 4 analog outputs | 1.1: X2.2(+) / X2.3(-) 1.2: X2.1(+) / X2.3(-) 1.3: X1.2(+) / X1.3(-) 1.4: X1.1(+) / X1.3(-) | 2.1: X4.2(+) / X4.3(-) 2.2: X4.1(+) / X4.3(-) 2.3: X3.2(+) / X3.3(-) 2.4: X3.1(+) / X3.3(-) |
| 4 digital inputs (active) | 1.1: X1.1(-) / X1.3(+) 1.2: X1.2(-) / X1.3(+) 1.3: X2.1(-) / X2.3(+) 1.4: X2.2(-) / X2.3(+) | 2.1: X3.1(-) / X3.3(+) 2.2: X3.2(-) / X3.3(+) 2.3: X4.1(-) / X4.3(+) 2.4: X4.2(-) / X4.3(+) |
| 4 digital inputs (passive) | 1.1: X1.1(+) / X1.3(-) 1.2: X1.2(+) / X1.3(-) 1.3: X2.1(+) / X2.3(-) 1.4: X2.2(+) / X2.3(-) | 2.1: X3.1(+) / X3.3(-) 2.2: X3.2(+) / X3.3(-) 2.3: X4.1(+) / X4.3(-) 2.4: X4.2(+) / X4.3(-) |
| 2 temperature inputs | 1.1: X1.2 / X1.3 1.2: X2.2 / X2.3 | 2.1: X3.2 / X3.3 2.2: X4.2 / X4.3 |

5.3 Possible cross sections and tightening torques

| Inputs L1(2), L2(5), L3(8), N(11), PE(16), I1(1-3), I2(4-6), I3(7-9), IN(10-12), power supply (13-14) | |
|---|--|
| Single wire | <ul style="list-style-type: none"> • 1 x 0,5...6.0mm² or 2 x 0,5...2.5mm² • 1 x 20 AWG...9 AWG or 2 x 20 AWG...14 AWG |
| Multiwire with end splices | <ul style="list-style-type: none"> • 1 x 0,5...4.0mm² or 2 x 0,5...2.5mm² • 1 x 20 AWG...11 AWG or 2 x 20 AWG...14 AWG |
| Tightening torque | <ul style="list-style-type: none"> • 0.5...0.6Nm • 4.42...5.31 lbf in |
| I/O's, relays, RS485 connector (A, B, C/X) | |
| Single wire | <ul style="list-style-type: none"> • 1 x 0.5 ... 2.5mm² or 2 x 0.5 ... 1.0mm² • 1 x 20 AWG...14 AWG or 2 x 20 AWG...17 AWG |
| Multiwire with end splices | <ul style="list-style-type: none"> • 1 x 0.5 ... 2.5mm² or 2 x 0.5 ... 1.5mm² • 1 x 20 AWG...14 AWG or 2 x 20 AWG...16 AWG |
| Tightening torque | <ul style="list-style-type: none"> • 0.5...0.6Nm • 4.42...5.31 lbf in |



You may have to remove first the plug-in terminals to get access to the screw terminals of the current inputs.

5.4 Inputs



All voltage measurement inputs must originate at circuit breakers or fuses rated 5 Amps or less. This does not apply to the neutral connector. You have to provide a method for manually removing power from the device, such as a clearly labeled circuit breaker or a fused disconnect switch in accordance with IEC 60947-2 or IEC 60947-3.

When using **voltage transformers** you have to ensure that their secondary connections never will be short-circuited.



No fuse may be connected upstream of the **current measurement inputs!**

When using **current transformers** their secondary connectors must be short-circuited during installation and before removing the device. Never open the secondary circuit under load.

Further hints

- The connection of the inputs depends on the configured system (connection type).
- **AM3000 only:** In the connection diagrams on the next pages conventional voltage transformers are used. If a voltage transformer with **extra windings** for measuring the homopolar voltage is applied, connections should be as shown below.

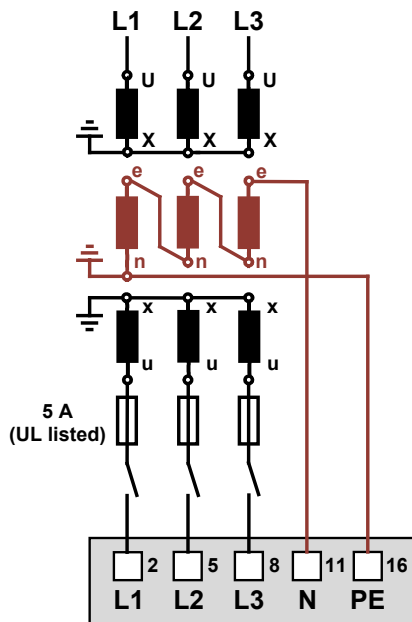

In order for the homopolar voltage to be measured, the item „Measure homopolar voltage“ must be set to „Yes“ in the settings of the measurement. This item is only available for 3-wire system types.

Single-phase AC mains

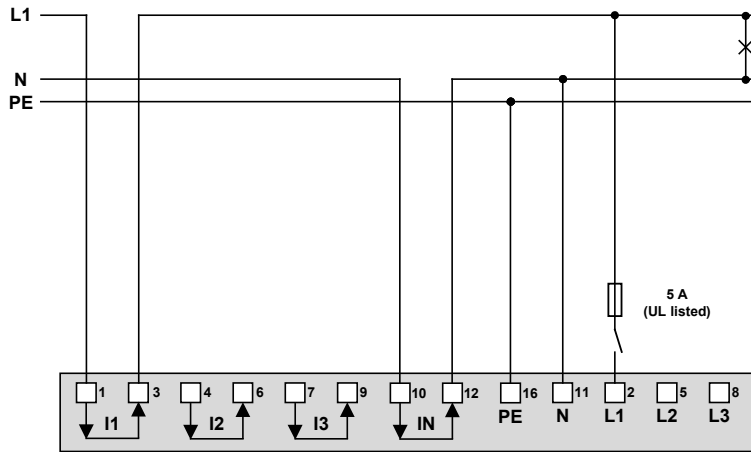

Direct connection

If current I_N or voltage U_{NE} does not need to be measured, connection of I_N or PE can be omitted.



Maximum permissible rated voltage
300V to ground!

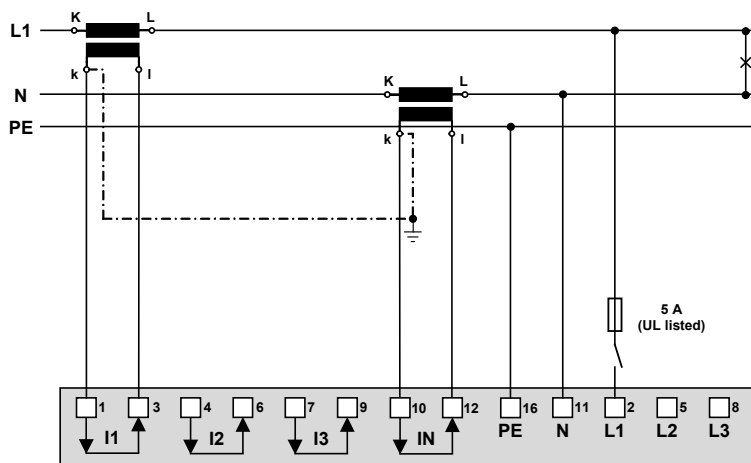

With current transformer

If current I_N does not need to be measured, the corresponding transformer can be omitted.

If voltage U_{NE} does not need to be measured, connection of PE can be omitted.

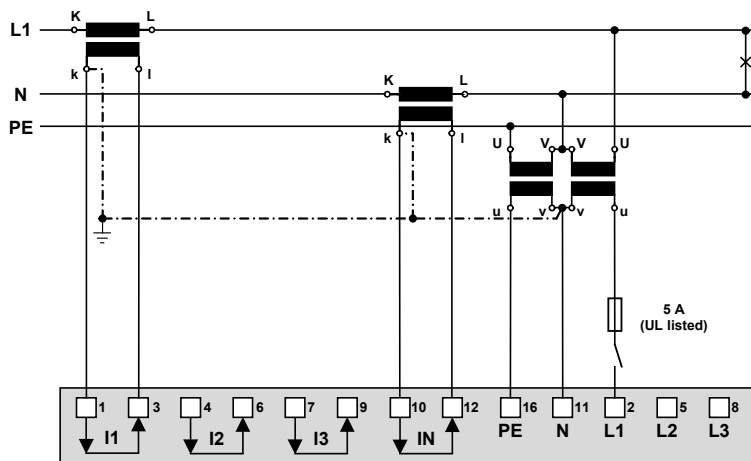

With current and voltage transformer

If current I_N or voltage U_{NE} does not need to be measured, the corresponding transformers can be omitted.

Three wire system, balanced load, phase shift
current measurement: L1, voltage measurement: L1-L2

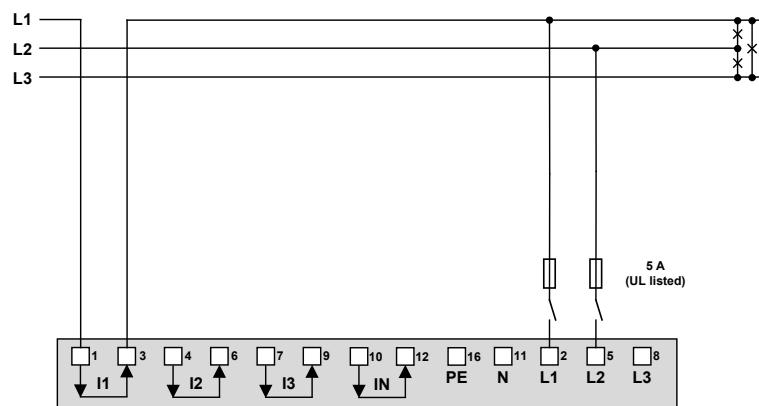

Direct connection

 Maximum permissible rated voltage
300V to ground (520V ph-ph)!

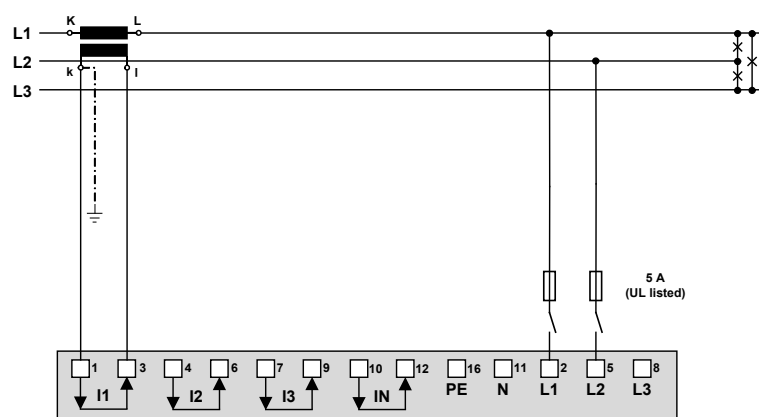

With current transformer

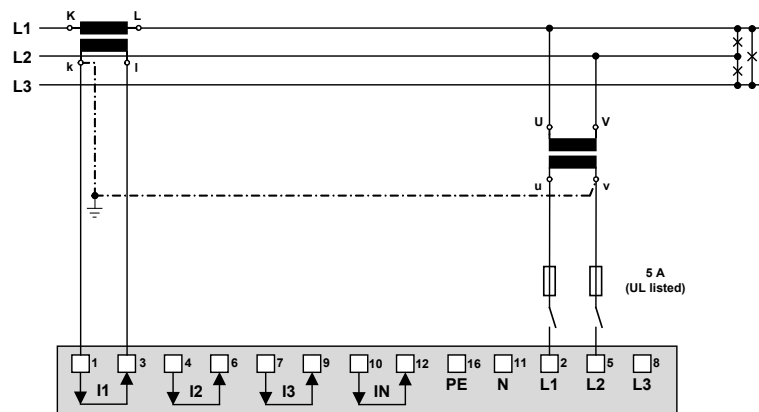

With current and voltage transformers

In case of current measurement via L2 or L3 connect the device according to the following table:

| Terminals | 1 | 3 | 2 | 5 | 8 |
|----------------------|----------|----------|----------|----------|----------|
| Current meas. via L2 | $I2(k)$ | $I2(l)$ | L2 | L3 | - |
| Current meas. via L3 | $I3(k)$ | $I3(l)$ | L3 | L1 | - |

Three wire system, balanced load, phase shift
current measurement: L1, voltage measurement: L2-L3

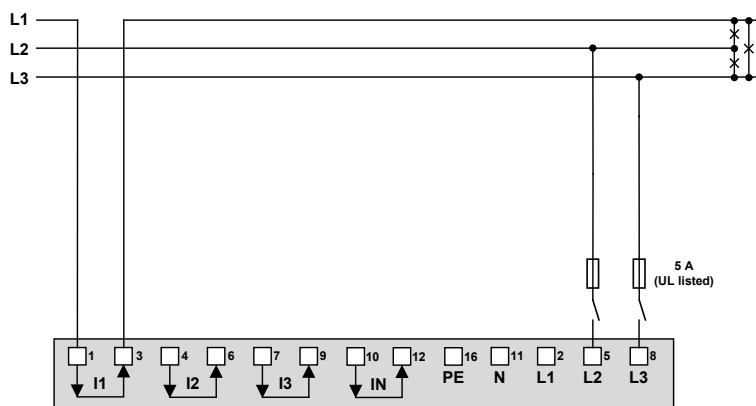

Direct connection

 Maximum permissible rated voltage
 300V to ground (520V ph-ph)!

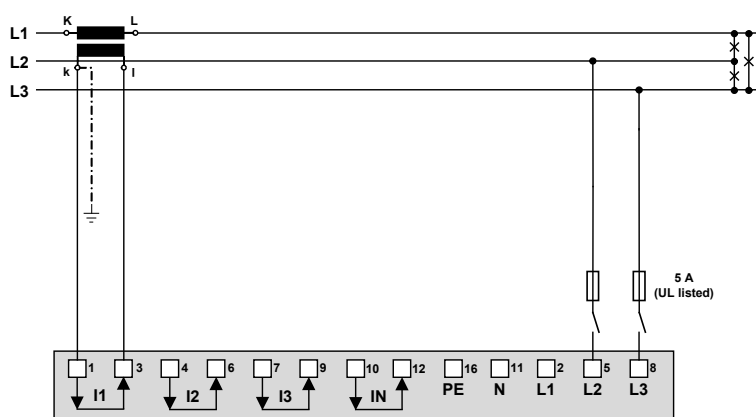

With current transformer

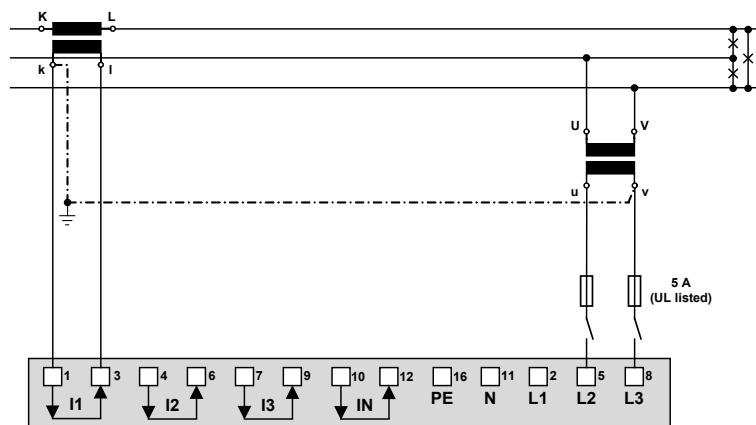

With current and voltage transformers

In case of current measurement via L2 or L3 connect the device according to the following table:

| Terminals | 1 | 3 | 2 | 5 | 8 |
|----------------------|----------|----------|----------|----------|----------|
| Current meas. via L2 | $I2(k)$ | $I2(l)$ | - | L3 | L1 |
| Current meas. via L3 | $I3(k)$ | $I3(l)$ | - | L1 | L2 |

Three wire system, balanced load, phase shift
current measurement: L1, voltage measurement: L3-L1

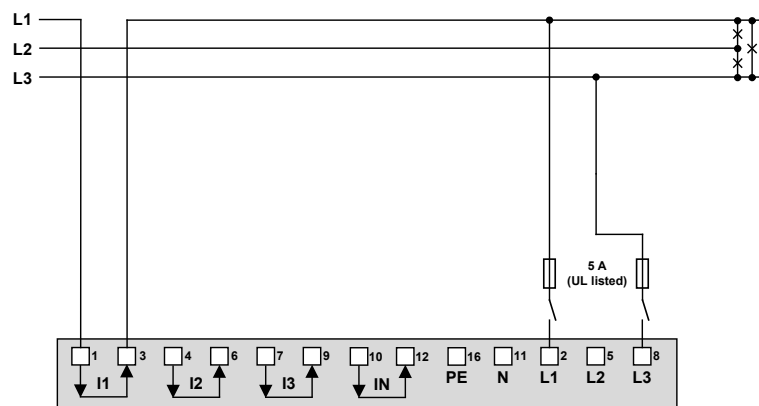

Direct connection

 Maximum permissible rated voltage
 300V to ground (520V ph-ph)!

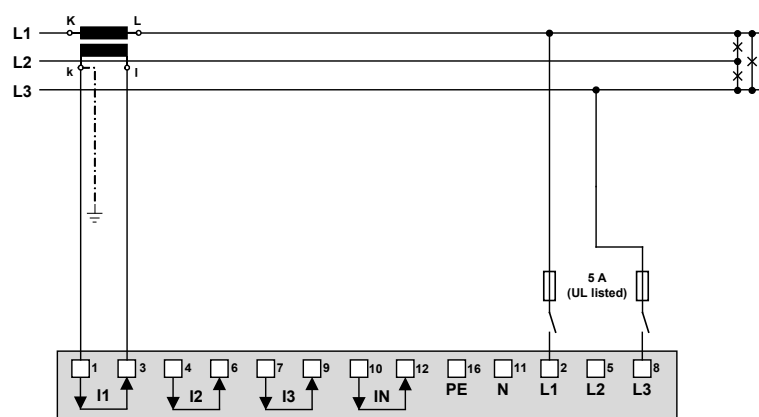

With current transformer

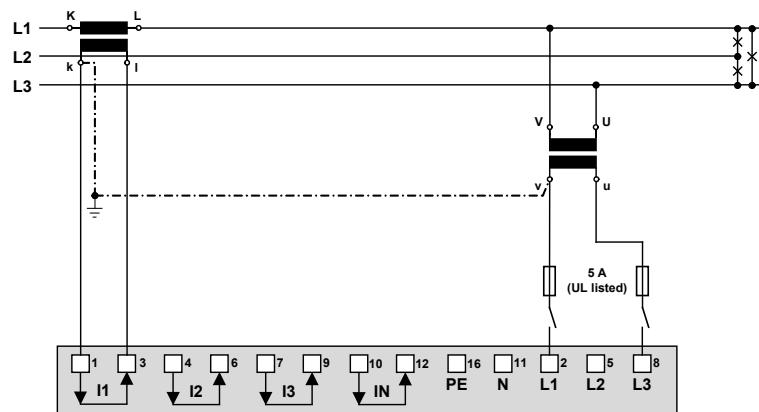

With current and voltage transformers

In case of current measurement via L2 or L3 connect the device according to the following table:

| Terminals | 1 | 3 | 2 | 5 | 8 |
|----------------------|----------|----------|----------|----------|----------|
| Current meas. via L2 | I2(k) | I2(l) | L2 | - | L1 |
| Current meas. via L3 | I3(k) | I3(l) | L3 | - | L2 |

Three wire system, balanced load, current measurement via L1

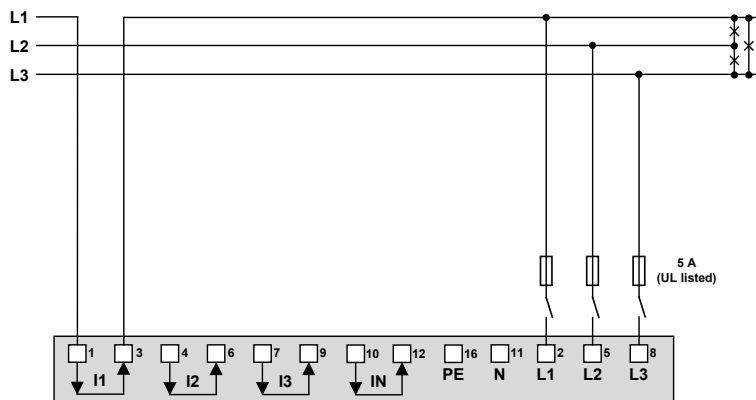

Direct connection



Maximum permissible rated voltage
300V to ground (520V ph-ph)!

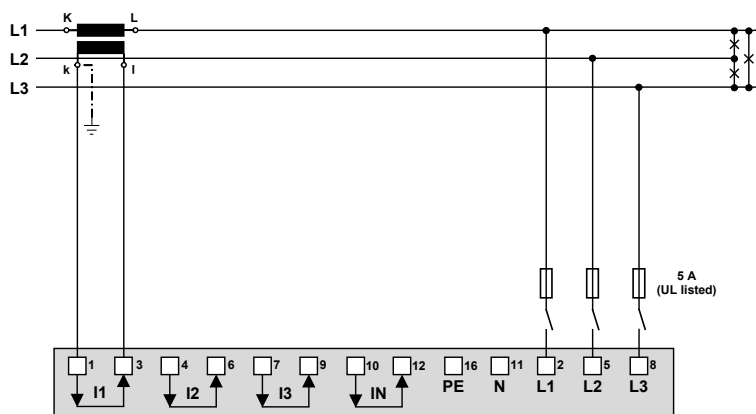

With current transformer

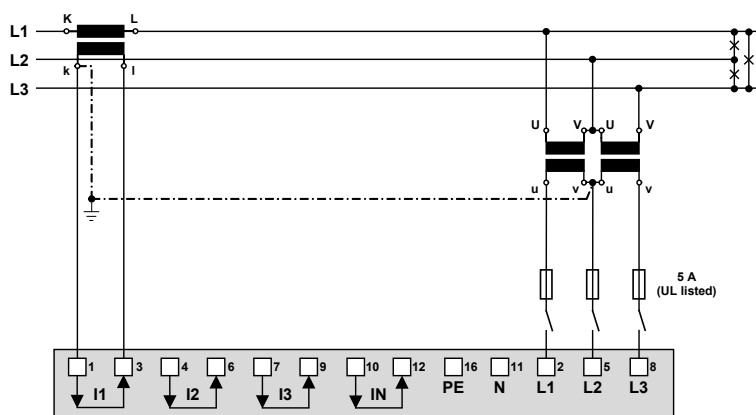

With current and voltage transformers

In case of current measurement via L2 or L3 connect the device according to the following table:

| Terminals | 1 | 3 | 2 | 5 | 8 |
|----------------------|-------|-------|----|----|----|
| Current meas. via L2 | I2(k) | I2(l) | L2 | L3 | L1 |
| Current meas. via L3 | I3(k) | I3(l) | L3 | L1 | L2 |



By rotating the voltage connections the measurements U_{12} , U_{23} and U_{31} will be assigned interchanged!

Four wire system, balanced load, current measurement via L1

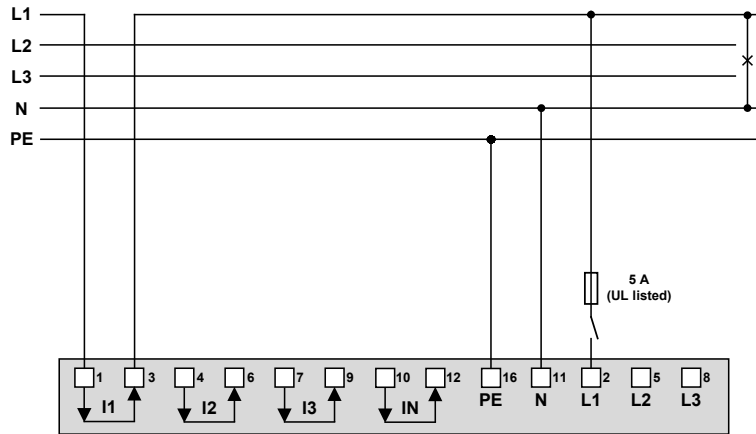

Direct connection

If voltage U_{NE} does not need to be measured, connection of PE can be omitted.

 Maximum permissible rated voltage 300V to ground!

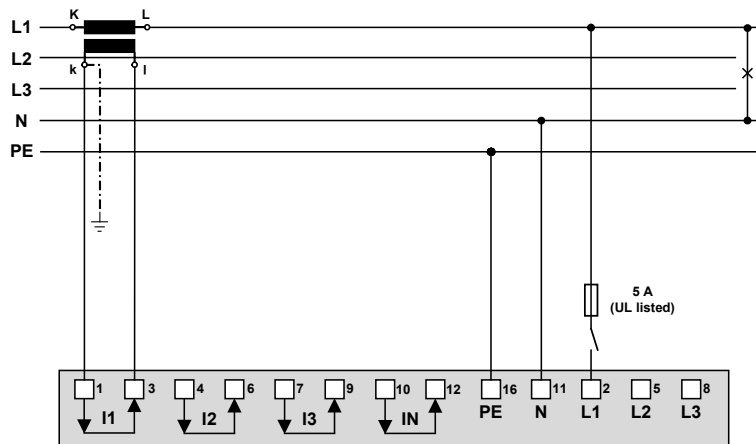

With current transformer

If voltage U_{NE} does not need to be measured, connection of PE can be omitted.

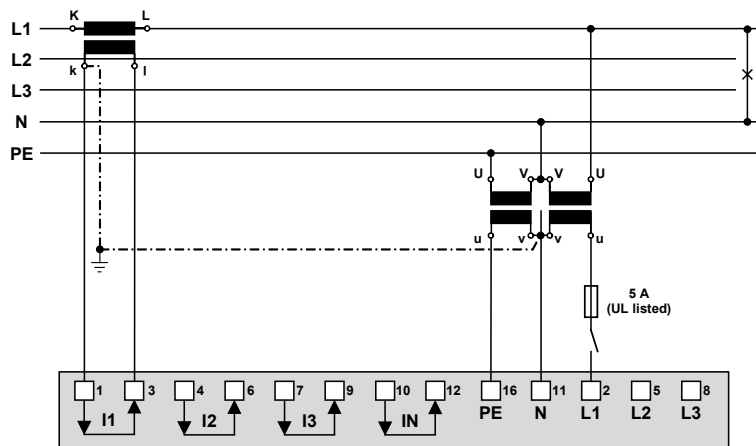

With current and voltage transformer

If voltage U_{NE} does not need to be measured, the corresponding transformer can be omitted.

In case of current measurement via L2 or L3 connect the device according to the following table:

| Terminals | 1 | 3 | 2 | 11 |
|----------------------|---------|---------|----|----|
| Current meas. via L2 | $I2(k)$ | $I2(l)$ | L2 | N |
| Current meas. via L3 | $I3(k)$ | $I3(l)$ | L3 | N |

Three wire system, unbalanced load

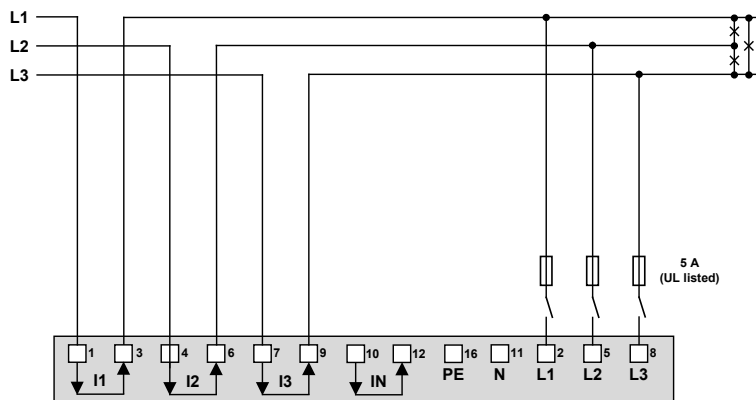

Direct connection



Maximum permissible rated voltage
300V to ground (520V ph-ph)!

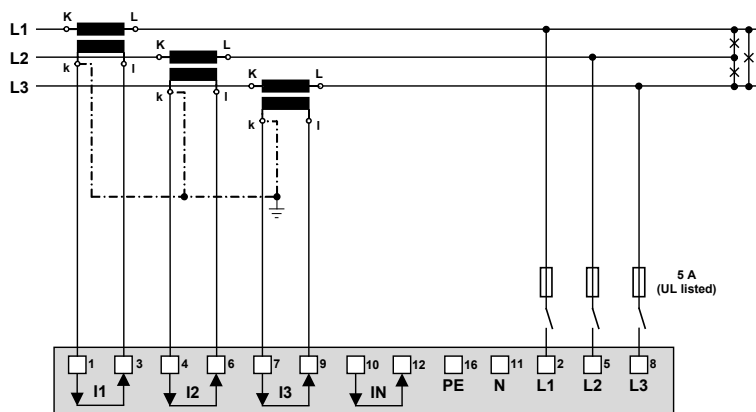

With current transformers

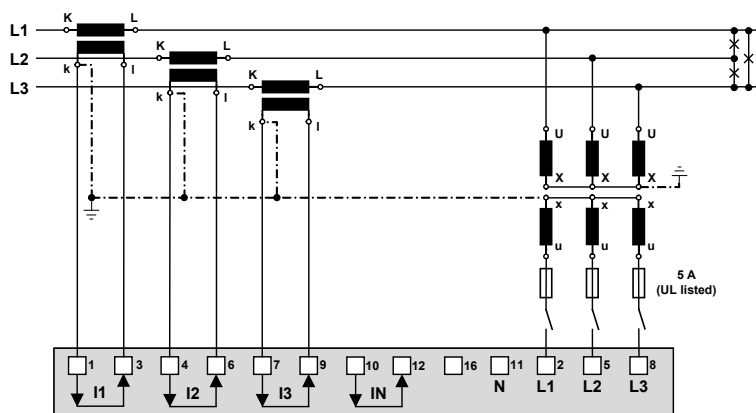

With current and 3 single-pole isolated
voltage transformers

Three wire system, unbalanced load, Aron connection

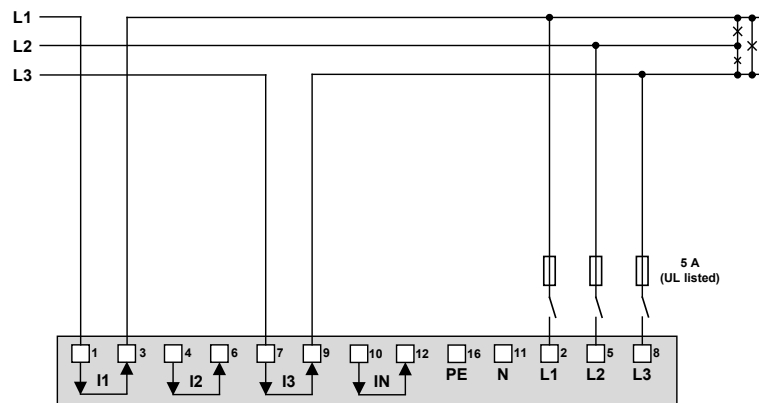

Direct connection

 Maximum permissible rated voltage
300V to ground (520V ph-ph!)

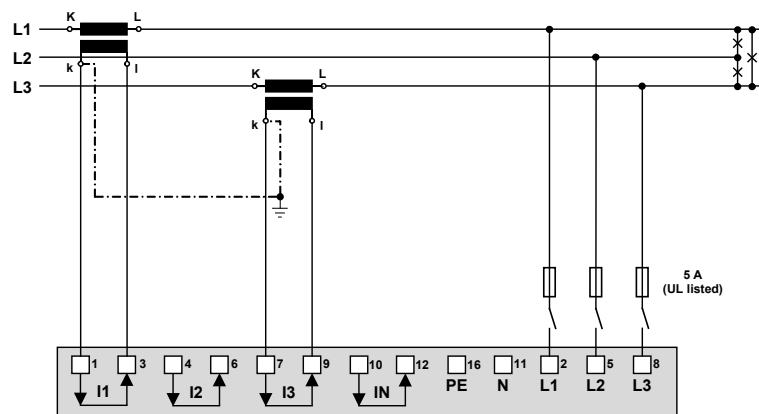

With current transformers

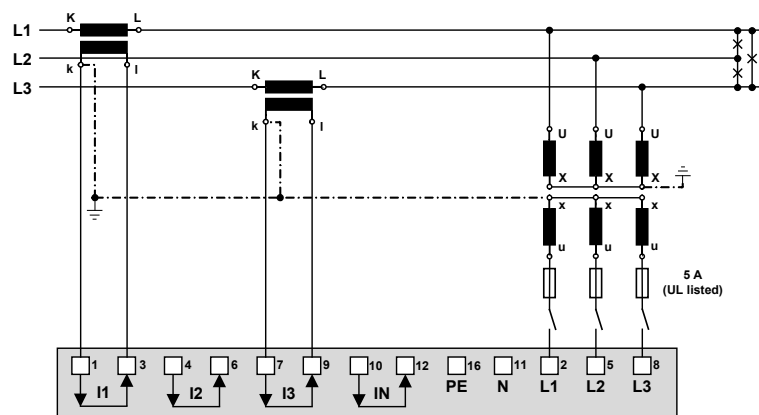

With current and 3 single-pole isolated voltage transformers

Four wire system, unbalanced load

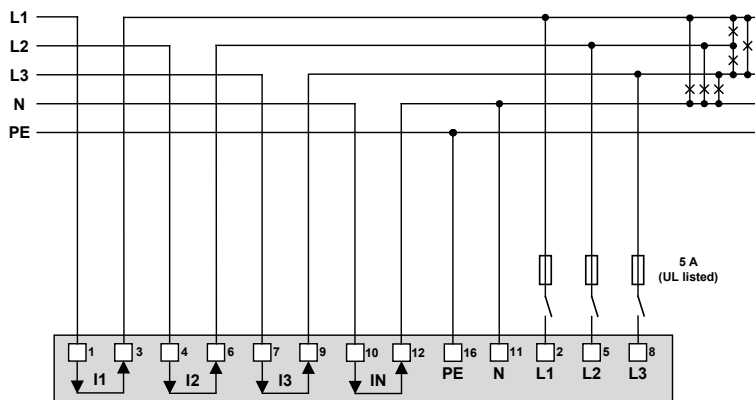

Direct connection

If current I_N or voltage U_{NE} does not need to be measured, connection of IN or PE can be omitted.



Maximum permissible rated voltage
300V to ground (520V ph-ph)!

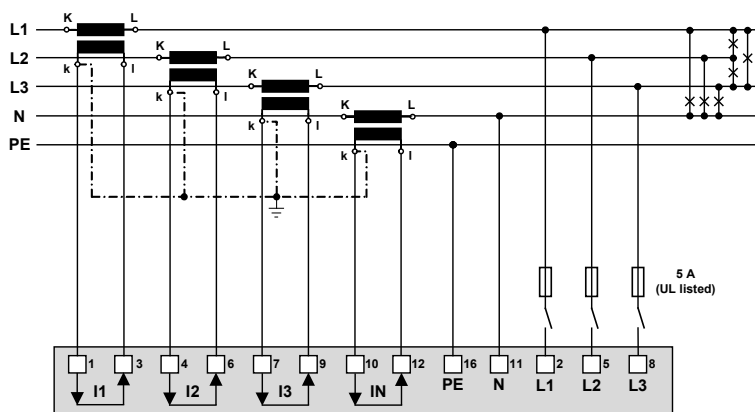

With current transformer

If voltage U_{NE} does not need to be measured, connection of PE can be omitted.

If current I_N does not need to be measured, the corresponding transformer can be omitted.

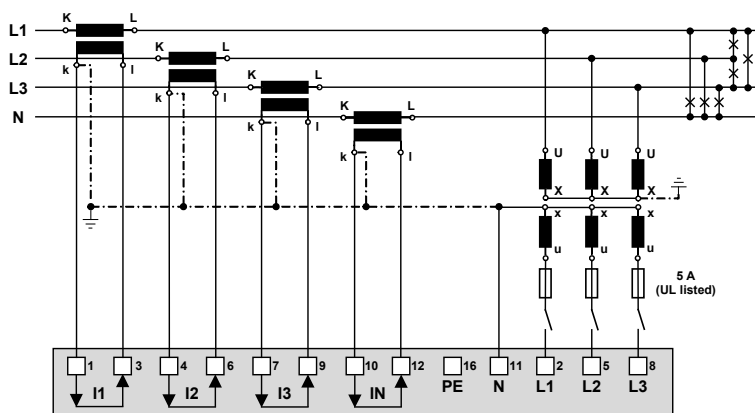

With current and voltage transformer

If current I_N does not need to be measured, the corresponding transformer can be omitted.

Four wire system, unbalanced load, Open-Y

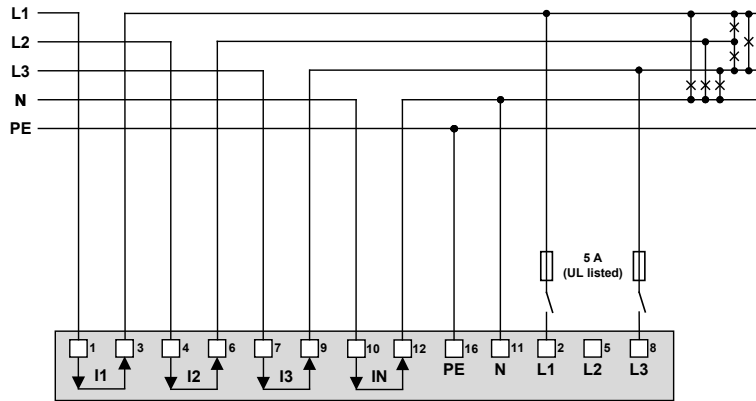

Direct connection

If current I_N or voltage U_{NE} does not need to be measured, connection of IN or PE can be omitted.

 Maximum permissible rated voltage 300V to ground (520V ph-ph)!

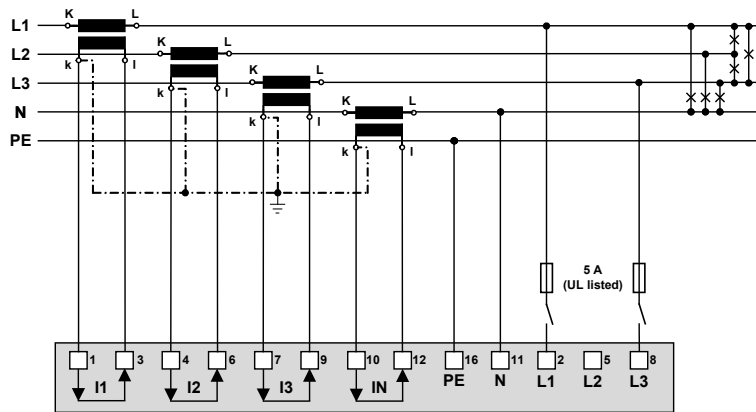

With current transformer

If voltage U_{NE} does not need to be measured, connection of PE can be omitted.

If current I_N does not need to be measured, the corresponding transformer can be omitted.

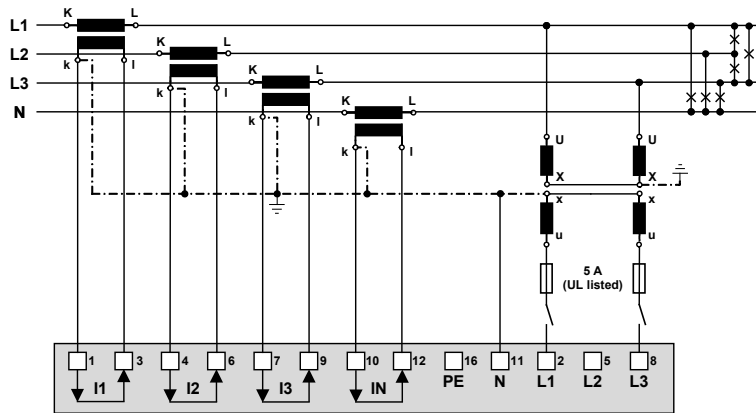

With current and voltage transformer

If current I_N does not need to be measured, the corresponding transformer can be omitted.

Split-phase ("two phase system"), unbalanced load

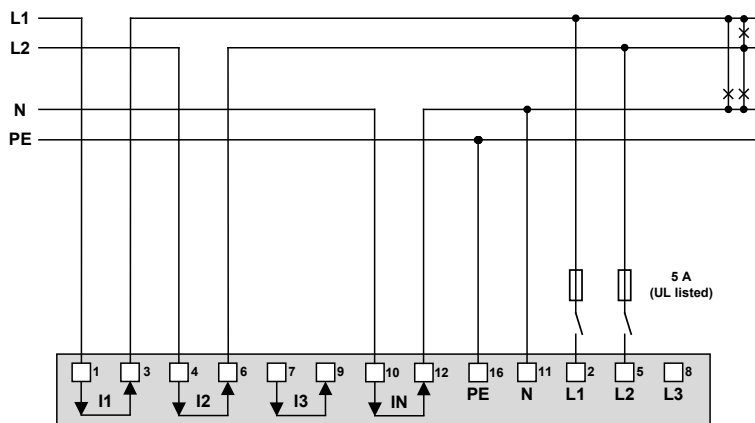

Direct connection



Maximum permissible rated voltage
300V to ground (600V ph-ph)!

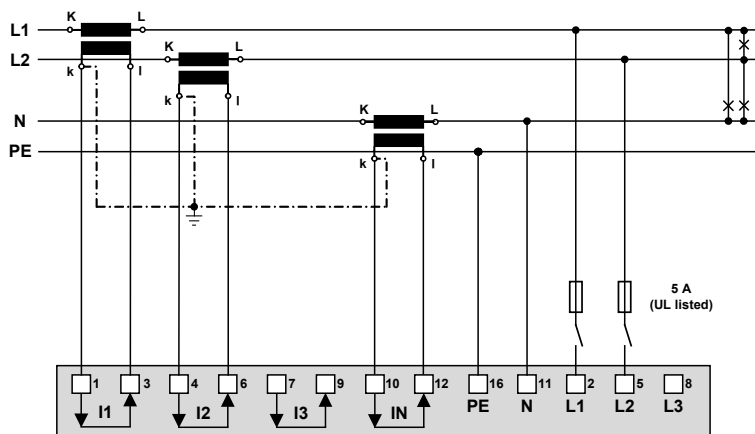

With current transformers

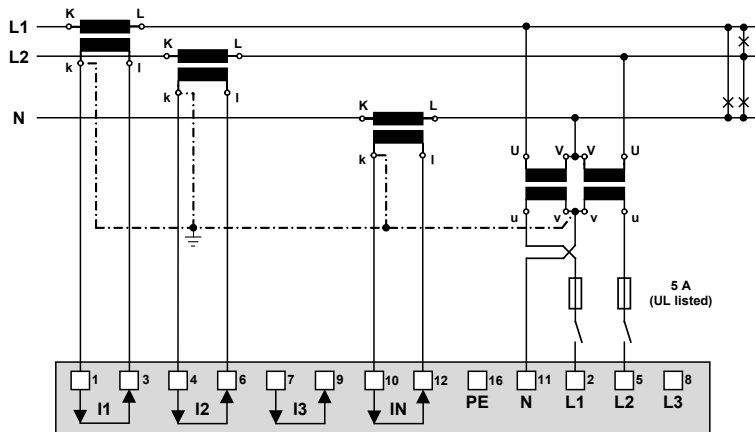

With current and voltage transformer

In systems without a primary neutral conductor a voltage transformer with a secondary center tap can also be used.

5.5 Power supply



A marked and easily accessible current limiting switch in accordance with IEC 60947-2 has to be arranged in the vicinity of the device for turning off the power supply. Fusing should be 10 Amps or less and must be rated for the available voltage and fault current.

5.6 Relays



When the device is switched off the relay contacts are de-energized, but dangerous voltages may be present.

Relays are available for device versions with corresponding I/O extensions only.

CU3000

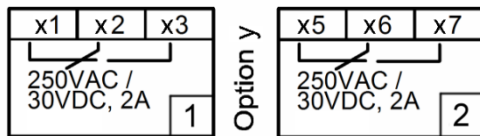

| Option y | x |
|----------|---|
| 1 | 5 |
| 2 | 6 |
| 4 | 3 |

CU5000

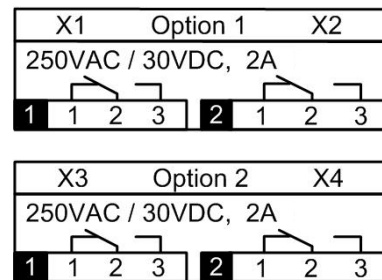

5.7 Digital inputs

The device provides a standard passive digital input. In addition, depending on the device version, there may be 4-channel passive or active digital input modules available.

Usage of the standard digital input

- ▶ Status input
- ▶ Meter tariff switching

Usage of the inputs of the optional input modules

- ▶ Counting input for pulses of meters for any kind of energy (pulse width 70...250ms)
- ▶ Operating feedback of loads for operating time counters
- ▶ Trigger and release signal for monitoring functions

Passive inputs (external power supply with 12 / 24 VDC required)



The power supply shall not exceed 30V DC!

CU3000

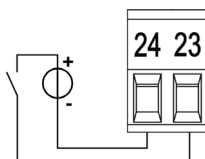
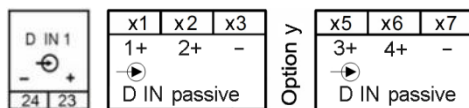

| Option y | x |
|----------|---|
| 1 | 5 |
| 2 | 6 |
| 3 | 4 |
| 4 | 3 |

CU5000

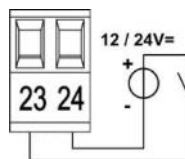
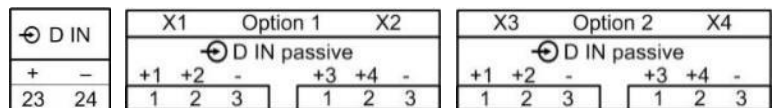

Technical data

| | |
|---------------|-----------------|
| Input current | < 7,0 mA |
| Logical ZERO | - 3 up to + 5 V |
| Logical ONE | 8 up to 30 V |

Active inputs (no external power supply required)

Technical data (acc. EN62053-31, class B)

Open circuit voltage $\leq 15\text{ V}$

Short circuit current $< 15\text{ mA}$

Current at $R_{ON}=800\Omega \geq 2\text{ mA}$

CU3000

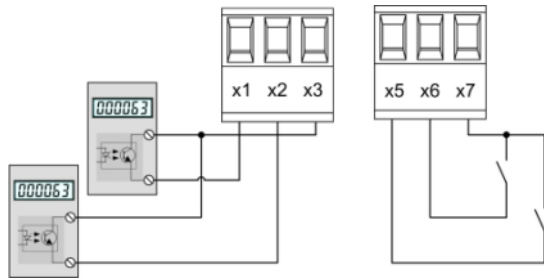
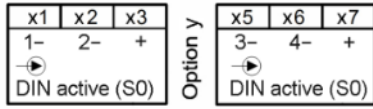

| Option y | x |
|----------|---|
| 1 | 5 |
| 2 | 6 |
| 3 | 4 |
| 4 | 3 |

Example with meter pulse and status inputs

CU5000

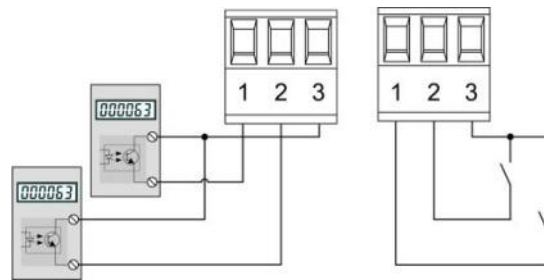
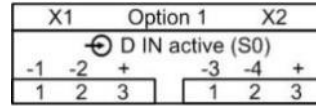

5.8 Digital outputs

The device has two standard digital outputs for which an external 12 / 24 VDC power supply is required.

 The power supply shall not exceed 30V DC!

Usage as digital output

- ▶ Alarm output
- ▶ State reporting
- ▶ Pulse output to an external counter (acc. EN62053-31)
- ▶ Remote controlled output

CU3000

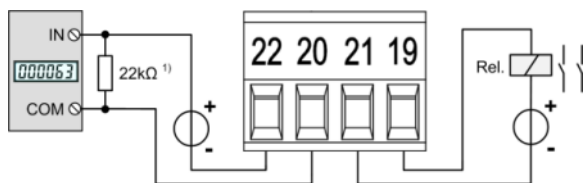
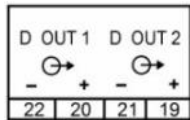

¹⁾ Recommended if input impedance of counter > 100 kΩ

CU5000

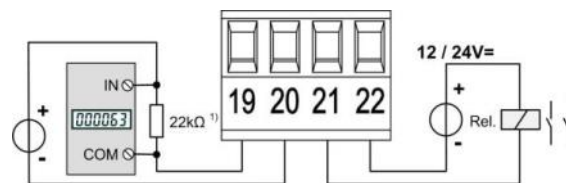
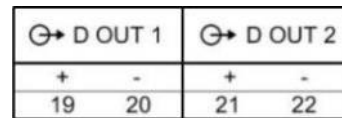

Driving a counter mechanism

The width of the energy pulses can be selected within a range of 30 up to 250ms, but have to be adapted to the external counter mechanism.

Electro mechanical meters typically need a pulse width of 50...100ms.

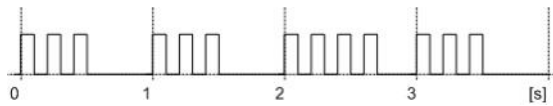

Driving a relay

| | |
|--------------------------|--------------------|
| Rated current | 50 mA (60 mA max.) |
| Switching frequency (S0) | ≤ 20 Hz |
| Leakage current | 0,01 mA |
| Voltage drop | < 3 V |

5.9 Analog outputs

Analog outputs are available for devices with corresponding I/O extensions only. See nameplate. Analog outputs may be remote controlled.

CU3000

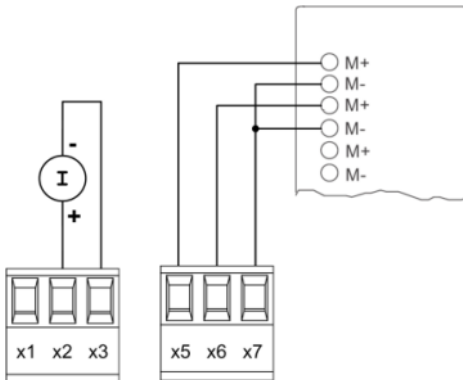
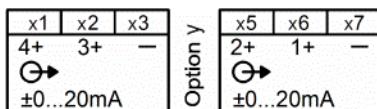

| Option y | x |
|----------|---|
| 1 | 5 |
| 2 | 6 |
| 3 | 4 |
| 4 | 3 |

CU5000

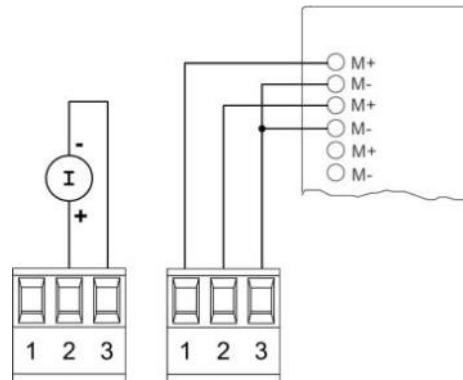
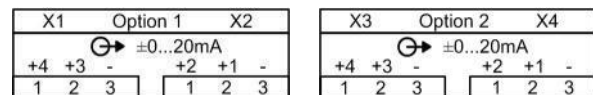

Connection to an analog input card of a PLC or a control system

The device is an isolated measurement device. The individual outputs are galvanically connected, but the modules are isolated from each other. To reduce the influence of disturbances shielded a twisted-pair cables should be used. The shield should be connected to earth on both opposite ends. If there are potential differences between the ends of the cable the shield should be earthed on one side only to prevent from equalizing currents.

Under all circumstances consider as well appropriate remarks in the instruction manual of the system to connect.

5.10 Fault current detection

Each fault current module provides **two channels** for monitoring differential or fault currents in earthed AC current systems. In any case measurement has to be performed via suitable current transformers, a direct measurement is not possible. The module is not suited for monitoring operating currents of normally live conductors (L1, L2, L3, N).

Measurement ranges

Each channel provides two measurement ranges:

a) Measurement range 1A

- Application: Direct measurement of a fault or earth wire current
- Meas. transformer: Current transformer 1/1 bis 1000/1A; 0.2 up to 1.5VA; Instrument security factor FS5

b) Measurement range 2mA

- Application: Residual current monitoring (RCM)
- Meas. transformer: Residual current transformer 500/1 up to 1000/1A
Rated burden 100 Ω / 0.025 VA up to 200 Ω / 0.06 VA



Use only transformers intended for this application, according to our current transformer catalog, or transformers that fulfill the above specification. Using transformers with divergent specifications may damage the measurement inputs.

Connection

CU3000

| | | | | | | |
|------------|-----|-----|----------|------------|-----|-----|
| x1 | x2 | x3 | Option y | x5 | x6 | x7 |
| 1A | 2mA | COM | | 1A | 2mA | COM |
| ⊖ | I > | | | ⊖ | I > | |
| (50/60 Hz) | | 1 | | (50/60 Hz) | | 2 |

| Option y | x |
|----------|---|
| 1 | 5 |
| 2 | 6 |
| 3 | 4 |
| 4 | 3 |

CU5000

| | | | | | | | | |
|------------------|-----|---|----------|---|---|----|-----|---|
| X1 | | | Option 1 | | | X2 | | |
| ⊖ I > (50/60 Hz) | | | | | | | | |
| 1A | 2mA | C | | | | 1A | 2mA | C |
| 1 | 1 | 2 | 3 | 2 | 1 | 2 | 3 | 3 |

| | | | | | | | | |
|------------------|-----|---|----------|---|---|----|-----|---|
| X3 | | | Option 2 | | | X4 | | |
| ⊖ I > (50/60 Hz) | | | | | | | | |
| 1A | 2mA | C | | | | 1A | 2mA | C |
| 1 | 1 | 2 | 3 | 2 | 1 | 2 | 3 | 3 |



The current transformers including the conductor isolation must guarantee in total a reinforced or double insulation between the mains circuit connected on the primary side and the measuring inputs of the device.



Only one measurement range may be connected per measuring channel!



The COM connectors of both measurement channels are internally connected.



For 2mA inputs a connection monitoring (breakage) is implemented. An alarm state is signaled for the respective measurement channels if either the current transformer is disconnected or the connection to the transformer is interrupted.

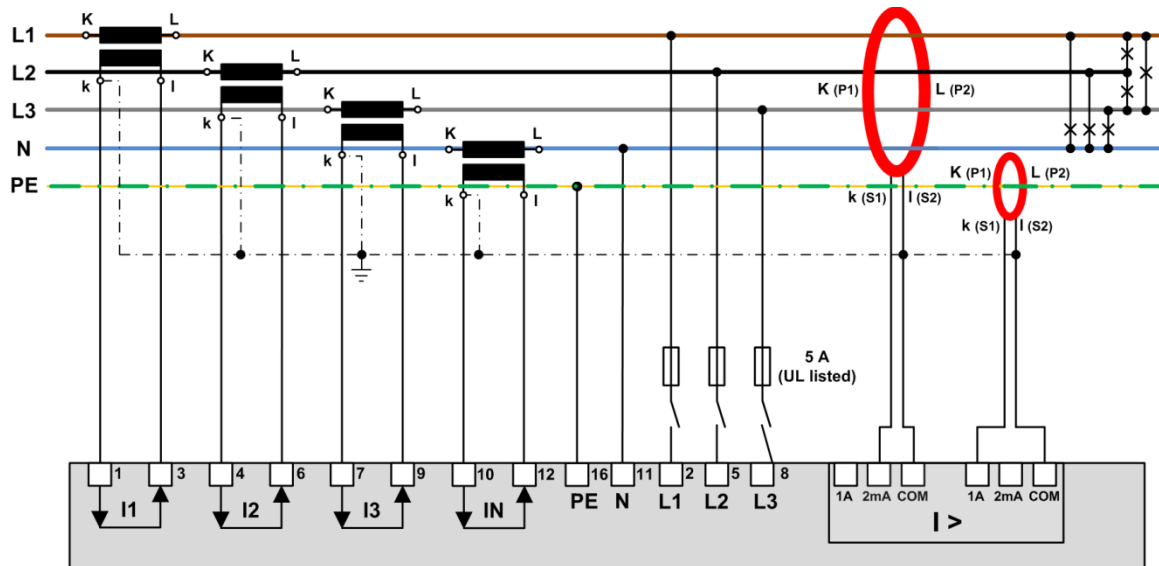

Example: Fault current monitoring in a TNS system

Hints

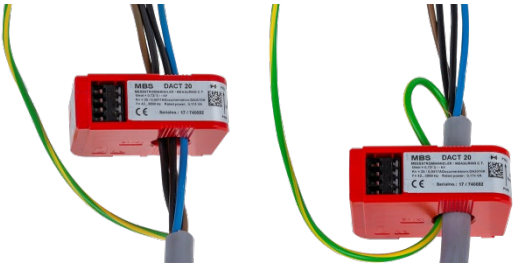
- (1) If the current transformers for the fault current detection needs to be grounded on the secondary side this has to be done via the COM connector.
- (2) Note that all conductors have to pass through the opening of the residual current transformer in the same direction.
- (3) A possible fault current flows through the protective earth conductor (PE). It can only be detected if the PE conductor is *not* routed through the residual current transformer. If this cannot be avoided, e.g. due to using a multi-wire cable with all conductors, the PE conductor must be returned through the transformer.
 
- (4) The cable or individual conductors should be routed through the transformer as centered as possible in order to minimize measurement errors.
- (5) Neither the current transformers nor the measurement leads should be mounted or installed close to strong magnetic fields. Measurement lines should also not be laid in parallel to power lines.
- (6) *For measurement range 1A only:* The rated output of the transformer must be chosen that it is reached when the rated secondary current (1A) flows. Consider that the burden of the transformer is not only made up by the burden of the measurement input, but also by the resistance of the measurement lines and the self-consumption of the transformer (copper losses).
 - A rated output selected too low leads to saturation losses in the transformer. The secondary rated current can no longer be reached as the transformer reaches its limits before.
 - A rated output selected too high or an exceeding instrument security factor (>FS5) may cause damage to the measuring inputs in case of overload.
- (7) For the connection of the transformer to the fault detection module use ...
 - Conductor cross sections of 1.0 up to 2.5mm² (16-14 AWG)
 - Pairwise twisted conductors in case of short cable lengths
 - Shielded cables (shield grounded on one side only) in disturbed environment or in case of long cable lengths

5.11 Temperature inputs

Each temperature module provides **two channels** for temperature monitoring. They can be used in two ways:

a) Temperature measurement via Pt100 sensor

- Measurement range: -50 up to 250°C
- 2 configurable alarm limits
- Configurable alarm delay time for ON / OFF
- Short circuit and wire / sensor breakage monitoring

b) Temperature monitoring with PTC sensors

- Monitoring the PTC response temperature
- Short circuit monitoring
- Serial connection of up to 6 single sensors or up to 2 triplet sensors

Connection

CU3000

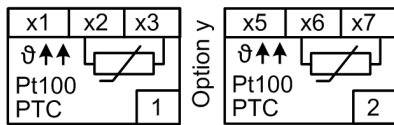

| Option y | x |
|----------|---|
| 1 | 5 |
| 2 | 6 |
| 3 | 4 |
| 4 | 3 |

CU5000

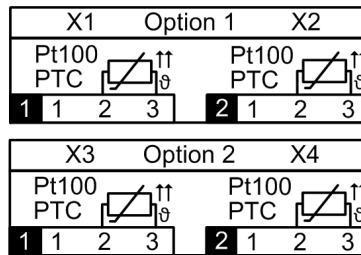

5.12 Modbus interface RS485

Via the optional Modbus interface measurement data may be provided for a superior system. However, the Modbus interface cannot be used for device parameterization.

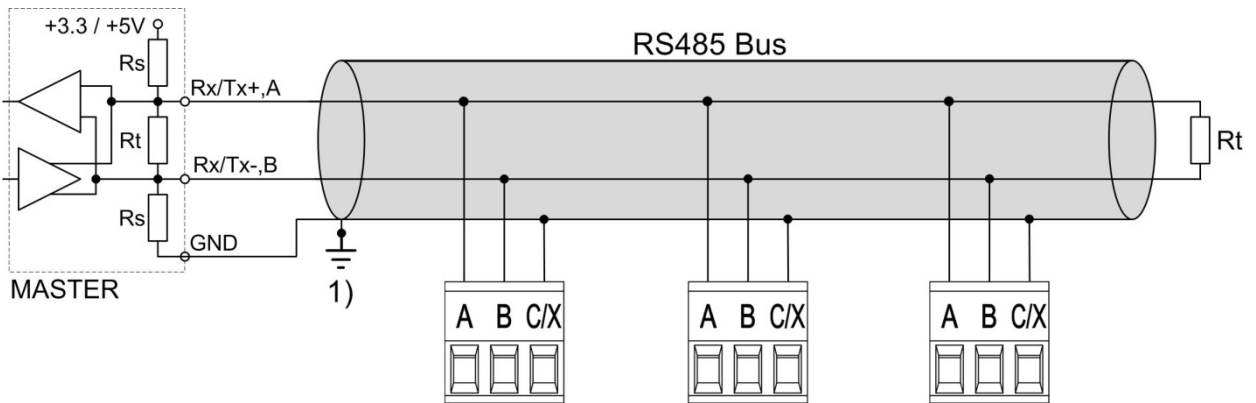

1) One ground connection only.
This is possibly made within the master (PC).

Rt: Termination resistors: 120 Ω each
for long cables (> approx. 10 m)

Rs: Bus supply resistors,
390 Ω each

The signal wires (A, B) have to be twisted. GND (C/X) can be connected via a wire or via the cable shield. In disturbed environments shielded cables must be used. Supply resistors (Rs) have to be present in bus master (PC) interface. Stubs should be avoided when connecting the devices. A pure line network is ideal. You may connect up to 32 Modbus devices to the bus. A proper operation requires that all devices connected to the bus have equal communication settings (baud rate, transmission format) and unique Modbus addresses.

The bus system is operated half duplex and may be extended to a maximum length of 1200 m without repeater.

5.13 Uninterruptible power supply (UPS)

The [battery pack](#) for the uninterruptible power supply is supplied separately. Please note that compared to the storage temperature range of the base unit the [storage temperature range](#) of the battery pack is restricted.

Ensure that devices with uninterruptible power supply are used in an environment in accordance with the [specification](#). Outside this operating temperature range, it is not ensured that the battery pack is recharged.

Due to aging the capacity of the battery decreases. To ensure a successful operation of the device during power interruptions the battery needs to be replaced every 3 up to 5 years.



Potential for Fire or Burning. Do not disassemble, crush, heat or burn the removed battery pack.

Replace battery pack with a [battery pack of the same type](#) only. Use of another battery may present a risk of fire or explosion.

5.14 GPS time synchronization

The optional GPS connection module serves for connecting a GPS receiver as a very accurate time synchronization source for the measurement device. The GPS receiver, available as an accessory, is used as outdoor antenna to process data from multiple GPS satellites simultaneously.

GPS receiver

Only use the receiver **Garmin GPS 16x-LVS** (article no. 181'131), offered as an accessory. This device is preconfigured by us and provides the required time information (sentences) without further configuration effort.

- Protection: IPx7 (waterproof)
- Operating temperature: -30...80°C
- Storage temperature: -40...80°C
- 1Hz pulse accuracy: 1µs
- Connector: RJ45



Choosing a mounting location

For a correct operation the GPS receiver requires data from at least 3 satellites at the same time. Therefore position the receiver so that the clearest possible view of the sky and horizon in all direction is obtained. This can be on the roof of a building, at best without reception being restricted by other buildings or obstacles. Avoid mounting the receiver next to large areas of conductible material, as this may cause poor signal reception. It should be also not closer than 1 meter away from any other antenna.



If lightning protection is required, this must be provided by the user.

Mounting the GPS receiver

- The GPS receiver **Garmin GPS 16x-LVS** can be flush mounted by means of 3 M4 screws.
- 120° distribution over a circle of $\varnothing 71.6\text{mm}$
- Thread length max. 8mm. Using longer screws may damage the GPS receiver.

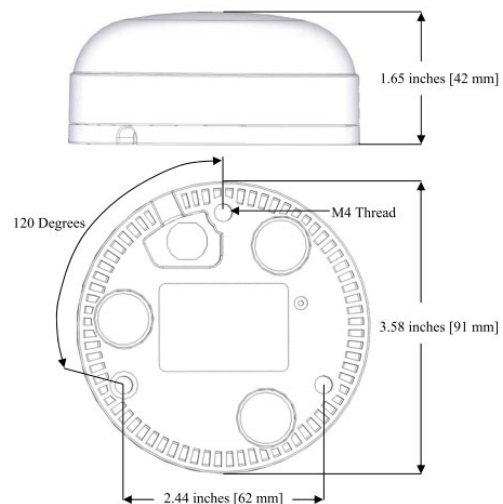

Connecting the GPS receiver



Never connect the RJ45 connector of the connecting cable directly to a network device such as a router or switch. These devices could be damaged.

The GPS receiver is plugged directly into the GPS connection module. The connection cable has a length of 5 m. It may be extended using an RJ45 coupling and an Ethernet cable. The connection cable should not be laid in parallel to live conductors. Twisting or sharp kinking of the cable should be avoided.

Commissioning

- In the settings menu change time synchronization to „NTP server / GPS“
- Check the time synchronization status

> Service > Device information > Device state

| | |
|--------------------------|----------------|
| Min/max values reset | Device version |
| Meter contents set/reset | Device license |
| Operating hours | Device state |
| Device information | |
| Factory reset | |
| Firmware update | |
| Communication Tests | |
| Device reboot | |

```
Interfaces -----
1) eth0
MAC:          00:12:34:1A:00:05
State:        Up
Link:         Yes
Speed:        100Mb/s
IP address:   192.168.62.142   [static]
Broadcast addr.: 192.168.63.255 [static]
Subnet mask:  255.255.248.0   [static]
Gateway addr.: 192.168.56.4   [static]

Name servers -----
DNS server 1: 192.168.56.55   [static]

Time sources -----
Source 1:     pool.ntp.org
Source 2:     Local clock
Source 3:     GPS

Time Synchronisation -----
synchronised to GPS at stratum 1
time correct to within 1 ms
polling server every 16 s

GPS Status -----
Number of satellites: 04
GPS quality: Differential fix
```

- The time synchronization can be restarted by switching the time synchronization off and on again.
- Time synchronization via GPS and NTP server may work in parallel. If both synchronization sources are available, the system uses the more accurate time source, which is normally GPS.



When connecting a GPS receiver for the first time or when it has been out of operation for a long time, it may take up to 1 hour for finding enough satellites for GPS receiver operation and thus for a reliable time synchronization.

6. Commissioning



Before commissioning you have to check if the connection data of the device match the data of the plant (see nameplates).

If so, you can start to put the device into operation by switching on the power supply and the measurement inputs.

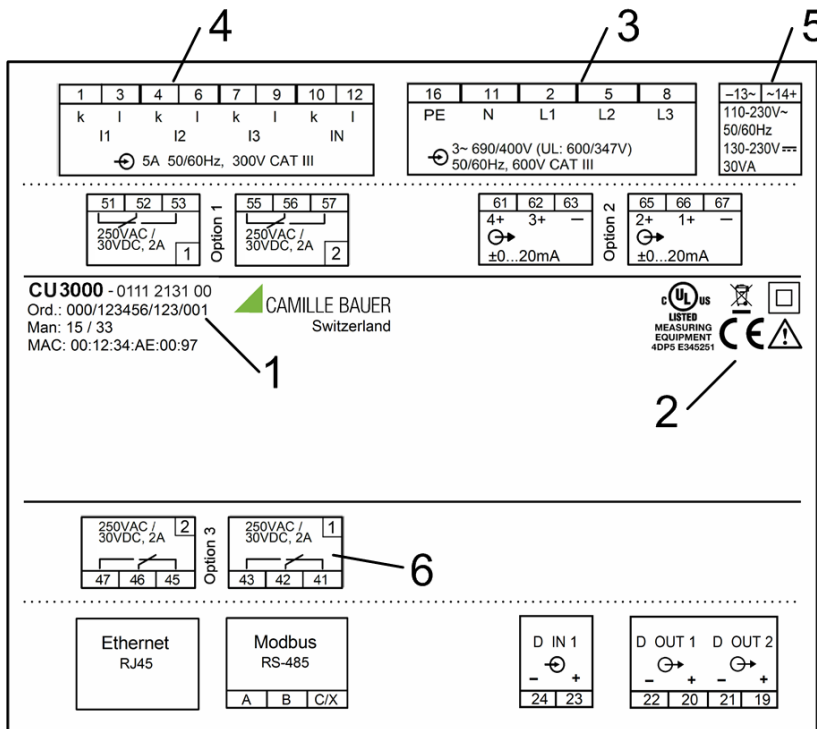

➤ Measurement input

Input voltage
 Input current
 System frequency

- 1 Serial number
- 2 Test and conformity marks
- 3 Assignment voltage inputs
- 4 Assignment current inputs
- 5 Assignment power supply
- 6 Load capacity relay outputs

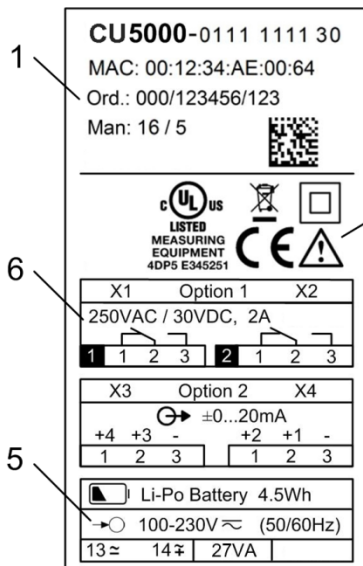

➤ Measurement input

Input voltage
 Input current
 System frequency

- 1 Serial number
- 2 Test and conformity marks
- 3 Assignment voltage inputs
- 4 Assignment current inputs
- 5 Assignment power supply
- 6 Load capacity relay outputs

6.1 Parametrization of the device functionality

A full parameterization of all functions of the device is possible directly at the device or via web browser. This assumes that user has the required access rights.

For security reasons, the security features “Users and Permissions” (RBAC) and “Web security” (HTTPS) may be activated. In this case, before the device webpage can be displayed using https, you have to [install a root certificate](#), which is provided via our homepage. Once the certificate is downloaded to the local computer the certificate can be installed manually. Just double-click on the file, and install the certificate as a trusted root certification authority.

See: [Configuration \(7.5\)](#)

6.2 Operating LED (CU5000 only)



The operating LED shows the present device state.

| Procedure | LED display |
|--|---|
| Booting of device | <ul style="list-style-type: none"> Flashes green (1 Hz) If successful: Change to static green display |
| Firmware update | <ul style="list-style-type: none"> Change to update mode: Static red During update: Flashes red (1 Hz) If successful or cancelled: Booting of device |
| Factory reset or reset of communication settings | <ul style="list-style-type: none"> During reset: Flashes red (1 Hz) Then: Booting of device |

6.3 Installation check

The correct connection of the current and voltage inputs can be checked in two ways.

- a) **Sense of rotation check:** Using the sequence of the current and voltage phasors the sense of rotation is determined and compared to the configured one. The phase rotation indicator is arranged in the menu “Phasor diagram”.

Test requirement: Magnitude of all connected voltages at least 5% of nominal, magnitude of all connected currents at least 0.2% of nominal.

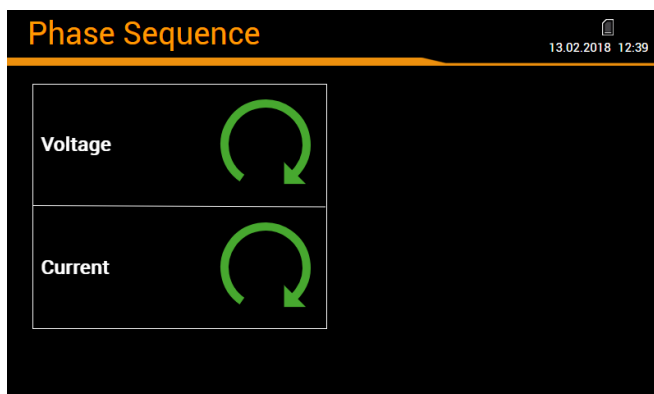

Possible results



Correct sense of rotation



Wrong sense of rotation



Missing phase or magnitude too small

b) **Phasor verification:** The phasor diagram shows a technical visualization of the current and voltage phasors, using a counter-clockwise rotation, independent of the real sense of rotation.

 **The diagram is always built basing on the voltage of the reference channel (direction 3 o'clock)**

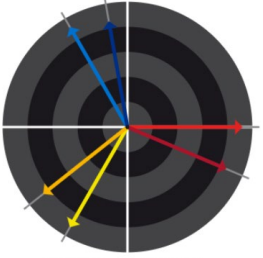
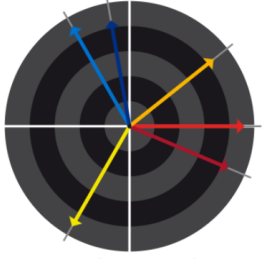
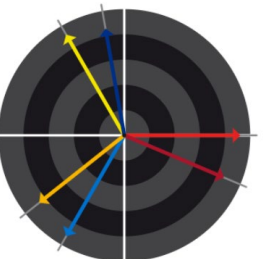
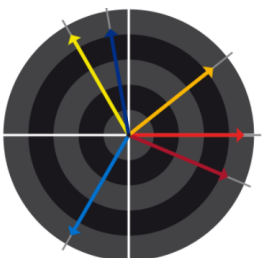
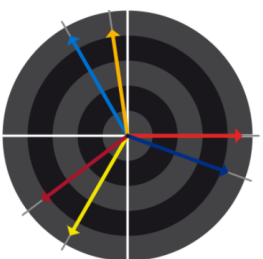
|  <p>50V/div 20A/div</p> <table border="1" data-bbox="539 353 821 504"> <thead> <tr> <th>L1</th> <th>L2</th> <th>L3</th> <th></th> </tr> </thead> <tbody> <tr> <td>230.60</td> <td>230.64</td> <td>230.54</td> <td>V</td> </tr> <tr> <td>0.00</td> <td>-119.97</td> <td>120.03</td> <td>*</td> </tr> <tr> <td>85.97</td> <td>86.03</td> <td>85.86</td> <td>A</td> </tr> <tr> <td>-22.9</td> <td>-21.7</td> <td>-20.0</td> <td>*</td> </tr> <tr> <td>0.921</td> <td>0.929</td> <td>0.940</td> <td>PF</td> </tr> </tbody> </table> | L1 | L2 | L3 | | 230.60 | 230.64 | 230.54 | V | 0.00 | -119.97 | 120.03 | * | 85.97 | 86.03 | 85.86 | A | -22.9 | -21.7 | -20.0 | * | 0.921 | 0.929 | 0.940 | PF | <p>Correct installation (expectation)</p> <ul style="list-style-type: none"> Voltage sequence in clock-wise order L1 → L2 → L3 ($0^\circ \rightarrow -120^\circ \rightarrow 120^\circ$) Current sequence in clock-wise order L1 → L2 → L3 Similar angle between voltage and current phasors in all phases (approx. -20°) |
|--|---------|---------|----|--|--------|--------|--------|---|------|---------|---------|---|-------|-------|-------|---|--------|--------|--------|---|--------|--------|--------|----|--|
| L1 | L2 | L3 | | | | | | | | | | | | | | | | | | | | | | | |
| 230.60 | 230.64 | 230.54 | V | | | | | | | | | | | | | | | | | | | | | | |
| 0.00 | -119.97 | 120.03 | * | | | | | | | | | | | | | | | | | | | | | | |
| 85.97 | 86.03 | 85.86 | A | | | | | | | | | | | | | | | | | | | | | | |
| -22.9 | -21.7 | -20.0 | * | | | | | | | | | | | | | | | | | | | | | | |
| 0.921 | 0.929 | 0.940 | PF | | | | | | | | | | | | | | | | | | | | | | |
|  <p>50V/div 20A/div</p> <table border="1" data-bbox="539 667 821 817"> <thead> <tr> <th>L1</th> <th>L2</th> <th>L3</th> <th></th> </tr> </thead> <tbody> <tr> <td>230.58</td> <td>230.63</td> <td>230.53</td> <td>V</td> </tr> <tr> <td>0.00</td> <td>-119.97</td> <td>120.03</td> <td>*</td> </tr> <tr> <td>85.96</td> <td>86.04</td> <td>85.87</td> <td>A</td> </tr> <tr> <td>-22.9</td> <td>158.4</td> <td>-20.0</td> <td>*</td> </tr> <tr> <td>0.921</td> <td>-0.930</td> <td>0.940</td> <td>PF</td> </tr> </tbody> </table> | L1 | L2 | L3 | | 230.58 | 230.63 | 230.53 | V | 0.00 | -119.97 | 120.03 | * | 85.96 | 86.04 | 85.87 | A | -22.9 | 158.4 | -20.0 | * | 0.921 | -0.930 | 0.940 | PF | <p>What's wrong?</p> <ul style="list-style-type: none"> Voltage sequence: L1 → L2 → L3 Current sequence: L1 → L3 → L2; Current L2 is out of the expected sequence Angle U-I: Angle between U_{L2} and I_{L2} is approx. 180° wrong <p>Required correction Reversing the polarity of current I_2</p> |
| L1 | L2 | L3 | | | | | | | | | | | | | | | | | | | | | | | |
| 230.58 | 230.63 | 230.53 | V | | | | | | | | | | | | | | | | | | | | | | |
| 0.00 | -119.97 | 120.03 | * | | | | | | | | | | | | | | | | | | | | | | |
| 85.96 | 86.04 | 85.87 | A | | | | | | | | | | | | | | | | | | | | | | |
| -22.9 | 158.4 | -20.0 | * | | | | | | | | | | | | | | | | | | | | | | |
| 0.921 | -0.930 | 0.940 | PF | | | | | | | | | | | | | | | | | | | | | | |
|  <p>50V/div 20A/div</p> <table border="1" data-bbox="539 981 821 1131"> <thead> <tr> <th>L1</th> <th>L2</th> <th>L3</th> <th></th> </tr> </thead> <tbody> <tr> <td>230.59</td> <td>230.49</td> <td>230.70</td> <td>V</td> </tr> <tr> <td>0.00</td> <td>120.04</td> <td>-119.99</td> <td>*</td> </tr> <tr> <td>85.97</td> <td>86.02</td> <td>85.86</td> <td>A</td> </tr> <tr> <td>-22.9</td> <td>98.3</td> <td>-140.0</td> <td>*</td> </tr> <tr> <td>0.921</td> <td>-0.145</td> <td>-0.766</td> <td>PF</td> </tr> </tbody> </table> | L1 | L2 | L3 | | 230.59 | 230.49 | 230.70 | V | 0.00 | 120.04 | -119.99 | * | 85.97 | 86.02 | 85.86 | A | -22.9 | 98.3 | -140.0 | * | 0.921 | -0.145 | -0.766 | PF | <p>What's wrong?</p> <ul style="list-style-type: none"> Voltage sequence: L1 → L3 → L2; L3 and L2 seems to be interchanged Current sequence: L1 → L2 → L3 Angle U-I: Angles between U_{L2} / I_{L2} and U_{L3} / I_{L3} do not correspond to the expectations <p>Required correction Exchanging the connections of the voltages L2 and L3</p> |
| L1 | L2 | L3 | | | | | | | | | | | | | | | | | | | | | | | |
| 230.59 | 230.49 | 230.70 | V | | | | | | | | | | | | | | | | | | | | | | |
| 0.00 | 120.04 | -119.99 | * | | | | | | | | | | | | | | | | | | | | | | |
| 85.97 | 86.02 | 85.86 | A | | | | | | | | | | | | | | | | | | | | | | |
| -22.9 | 98.3 | -140.0 | * | | | | | | | | | | | | | | | | | | | | | | |
| 0.921 | -0.145 | -0.766 | PF | | | | | | | | | | | | | | | | | | | | | | |
|  <p>50V/div 20A/div</p> <table border="1" data-bbox="539 1294 821 1444"> <thead> <tr> <th>L1</th> <th>L2</th> <th>L3</th> <th></th> </tr> </thead> <tbody> <tr> <td>230.58</td> <td>230.49</td> <td>230.68</td> <td>V</td> </tr> <tr> <td>0.00</td> <td>120.04</td> <td>-119.99</td> <td>*</td> </tr> <tr> <td>85.97</td> <td>86.04</td> <td>85.86</td> <td>A</td> </tr> <tr> <td>-22.9</td> <td>-81.6</td> <td>-140.0</td> <td>*</td> </tr> <tr> <td>0.921</td> <td>0.145</td> <td>-0.766</td> <td>PF</td> </tr> </tbody> </table> | L1 | L2 | L3 | | 230.58 | 230.49 | 230.68 | V | 0.00 | 120.04 | -119.99 | * | 85.97 | 86.04 | 85.86 | A | -22.9 | -81.6 | -140.0 | * | 0.921 | 0.145 | -0.766 | PF | <p>What's wrong?</p> <ul style="list-style-type: none"> Voltage sequence: L1 → L3 → L2; L3 and L2 seems to be exchanged Current sequence: L1 → L3 → L2; Current L2 is out of the expected sequence Angle U-I: Angles between U_{L2} / I_{L2} and U_{L3} / I_{L3} do not correspond to the expectations <p>Required correction Exchanging the connections of the voltages L2 and L3 and reversing the polarity of the current input I_2</p> |
| L1 | L2 | L3 | | | | | | | | | | | | | | | | | | | | | | | |
| 230.58 | 230.49 | 230.68 | V | | | | | | | | | | | | | | | | | | | | | | |
| 0.00 | 120.04 | -119.99 | * | | | | | | | | | | | | | | | | | | | | | | |
| 85.97 | 86.04 | 85.86 | A | | | | | | | | | | | | | | | | | | | | | | |
| -22.9 | -81.6 | -140.0 | * | | | | | | | | | | | | | | | | | | | | | | |
| 0.921 | 0.145 | -0.766 | PF | | | | | | | | | | | | | | | | | | | | | | |
|  <p>50V/div 20A/div</p> <table border="1" data-bbox="539 1608 821 1758"> <thead> <tr> <th>L1</th> <th>L2</th> <th>L3</th> <th></th> </tr> </thead> <tbody> <tr> <td>230.45</td> <td>230.48</td> <td>230.58</td> <td>V</td> </tr> <tr> <td>0.00</td> <td>-120.02</td> <td>119.98</td> <td>*</td> </tr> <tr> <td>85.96</td> <td>86.00</td> <td>85.86</td> <td>A</td> </tr> <tr> <td>-143.0</td> <td>-141.6</td> <td>-140.0</td> <td>*</td> </tr> <tr> <td>-0.798</td> <td>-0.784</td> <td>-0.766</td> <td>PF</td> </tr> </tbody> </table> | L1 | L2 | L3 | | 230.45 | 230.48 | 230.58 | V | 0.00 | -120.02 | 119.98 | * | 85.96 | 86.00 | 85.86 | A | -143.0 | -141.6 | -140.0 | * | -0.798 | -0.784 | -0.766 | PF | <p>What's wrong?</p> <ul style="list-style-type: none"> Voltage sequence: L1 → L2 → L3 Current sequence: L3 → L1 → L2 Angle U-I: The U-I angles do not correspond to the expectation, but are similar <p>Required correction Cyclical exchange of the voltage connections: $L1 \rightarrow L3$, $L2 \rightarrow L1$, $L3 \rightarrow L2$. As an alternative the sequence of all currents may be changed as well (more effort required).</p> |
| L1 | L2 | L3 | | | | | | | | | | | | | | | | | | | | | | | |
| 230.45 | 230.48 | 230.58 | V | | | | | | | | | | | | | | | | | | | | | | |
| 0.00 | -120.02 | 119.98 | * | | | | | | | | | | | | | | | | | | | | | | |
| 85.96 | 86.00 | 85.86 | A | | | | | | | | | | | | | | | | | | | | | | |
| -143.0 | -141.6 | -140.0 | * | | | | | | | | | | | | | | | | | | | | | | |
| -0.798 | -0.784 | -0.766 | PF | | | | | | | | | | | | | | | | | | | | | | |

6.4 Ethernet installation

6.4.1 Settings

Before devices can be connected to an existing Ethernet network, you have to ensure that they will not disturb the normal network service. The rule is:



None of the devices to connect is allowed to have the same IPv4/6 address than another device already installed

The device supports both IPv4 and IPv6 communication. IPv4 communication is activated by default; IPv6 can be activated additionally via configuration.

IPv4 communication

Depending on the device version, there may be multiple Ethernet interfaces with different default IPv4 addresses.

| Interface | Application | Default IPv4 | Settings via menu |
|-----------|----------------------------|---------------|-------------------------------------|
| Standard | Configuration / Modbus TCP | 192.168.1.101 | Settings Communication Ethernet |
| IEC 61850 | IEC61850 communication | 192.168.1.111 | Settings IEC61850 Ethernet |
| PROFINET | PROFINET communication | 0.0.0.0 | (exclusively via control system) |

IPv6 communication

Depending on the device version, there may be multiple Ethernet interfaces with different default IPv6 addresses, once the IPv6 communication is activated.

| Interface | Application | Default IPv6 | Settings via menu |
|-----------|----------------------------|------------------------|-------------------------------------|
| Standard | Configuration / Modbus TCP | fd2d:bb44:97f1:3976::1 | Settings Communication Ethernet |
| IEC 61850 | IEC61850 communication | fd2d:bb44:97f1:3976::B | Settings IEC61850 Ethernet |
| PROFINET | PROFINET communication | 0::0 | (exclusively via control system) |

Network settings (Communication | Ethernet)

The following settings have to be arranged with the network administrator:

| | |
|----------------------------------|--|
| • IPv4/6: IP address | Must be unique , i.e. may be assigned in the network only once |
| • IPv4: Subnet mask | Defines how many devices are directly addressable in the IPv4 network. This setting is equal for all the devices. Examples |
| • IPv4/6: Gateway address | Is used to resolve addresses during communication between different networks. It should contain a valid address within the directly addressable network |
| • IPv4/6: DNS-Server x | Is used to resolve a domain name into an address, if e.g. a name (pool.ntp.org) is used for the NTP server. Further information |
| • IPv6: Prefix length | Is comparable to the subnet mask in IPv4 networks; it is the number of the leftmost bits of the site prefix which need to be identical for direct communication. |
| • Hostname | Individual designation for each device. Via the hostname the device can be uniquely identified in the network. Therefore for each device a unique name should be assigned. |
| • NTP-Server x | NTP servers are used as base for time synchronization |

| | |
|-----------------------|--------------------------|
| IPv4: Mode | Static |
| IPv4: IP address | 192.168.62.25 |
| Subnet mask | 255.255.248.0 |
| IPv4: Gateway address | 192.168.56.5 |
| IPv4: DNS server 1 | 192.168.56.55 |
| IPv4: DNS server 2 | 192.168.56.155 |
| IPv6: Mode | Static |
| IPv6: IP address | fd2d:bb44:97f1:3976::3 |
| IPv6: Prefix length | 64 |
| IPv6: Gateway address | fd2d:bb44:97f1:3976::5:1 |
| IPv6: DNS server 1 | |
| IPv6: DNS server 2 | |
| Host name | PQ5000Exxxxx |
| Clock synchronization | NTP server / GPS |
| NTP server 1 | pool.ntp.org |
| NTP server 2 | |

Network settings of Standard interface

| | |
|-----------------------|--------------------|
| IP address | 192.168.62.103 |
| Subnet mask | 255.255.248.0 |
| Gateway address | 192.168.56.5 |
| DNS server 1 | 192.168.56.55 |
| DNS server 2 | 192.168.56.155 |
| Host name | PQ5000-IEC61850-RR |
| Clock synchronization | NTP server |
| NTP server 1 | pool.ntp.org |
| NTP server 2 | |

Network settings of IEC61850 interface

IPv4: Subnet mask

For a direct communication between device and PC both devices need to be in the same network when the subnet mask is applied:

| Example 1 | decimal | binary |
|---------------|-----------------|-------------------------------------|
| IP address | 192.168. 1.101 | 11000000 10101000 00000001 01100101 |
| Subnet mask | 255.255.255.224 | 11111111 11111111 11111111 11100000 |
| | variable range | xxxxxx |
| First address | 192.168. 1. 96 | 11000000 10101000 00000001 01100000 |
| Last address | 192.168. 1.127 | 11000000 10101000 00000001 01111111 |

► The device 192.168.1.101 can access directly the devices 192.168.1.96 ... 192.168.1.127

| Example 2 | decimal | binary |
|---------------|-----------------|-------------------------------------|
| IP address | 192.168. 57. 64 | 11000000 10101000 00111001 01000000 |
| Subnet mask | 255.255.252. 0 | 11111111 11111111 11111100 00000000 |
| | variable range | xx xxxxxxxx |
| First address | 192.168. 56. 0 | 11000000 10101000 00111000 00000000 |
| Last address | 192.168. 59.255 | 11000000 10101000 00111011 11111111 |

► The device 192.168.57.64 can access directly the devices 192.168.56.0 ... 192.168.59.255

IPv4: Mode >> DHCP

If a DHCP server is available, alternatively the mode „**DHCP**“ or „**DHCP, addresses only**“ can be selected for the Standard interface. The device then gets all necessary information from the DHCP server. The difference between the two modes is that for “DHCP” also the DNS server address is obtained.

The settings obtained from the DHCP server can be retrieved locally via the service menu.

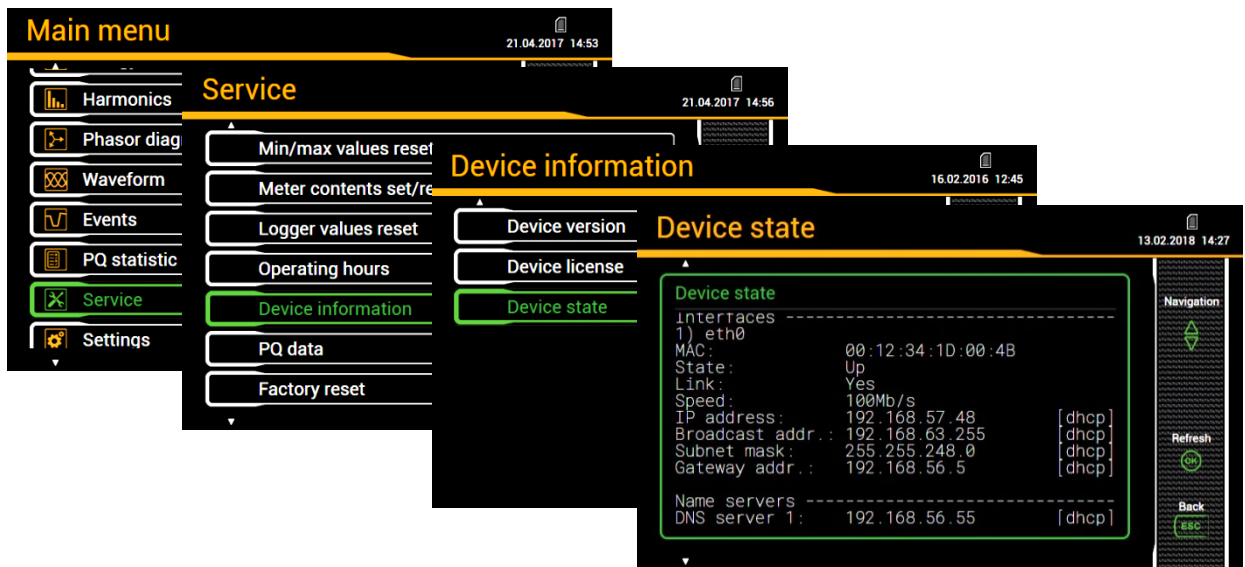

 Depending on the settings of the DHCP server the provided IP address can change on each reboot of the device. Thus it's recommended to use the DHCP mode during commissioning only.

Time synchronization via NTP protocol

For the *time synchronization* of devices via Ethernet *NTP* (Network Time Protocol) is the standard. Corresponding time servers are used in computer networks, but are also available for free via Internet. Using NTP it's possible to hold all devices on a common time base.

Two different NTP servers may be defined. If the first server is not available the second server is used for trying to synchronize the time.

If a public NTP server is used, e.g. “pool.ntp.org”, a name resolution is required. This normally happens via a **DNS server**. So, the IP address of the DNS server must be set in the communication settings of the Ethernet interface to make a communication with the NTP server, and thus time synchronization, possible. Your network administrator can provide you the necessary information.

The time synchronization of the Standard interface can be performed via a [GPS receiver](#) as well.

TCP ports

The TCP communication is done via so-called ports. The number of the used port allows determining the type of communication. As a standard Modbus/TCP communication is performed via TCP port 502, NTP uses port 123. However, the port for the Modbus/TCP communication may be modified. You may provide a unique port to each of the devices, e.g. 503, 504, 505 etc., for an easier analysis of the communication traffic. Independent of these setting a communication via port 502 is always supported. The device allows at least 5 connections to different clients at the same time.

Firewall

Due to security reasons nowadays each network is protected by means of a firewall. When configuring the firewall you have to decide which communication is desired and which have to be blocked. The TCP port 502 for the Modbus/TCP communication normally is considered to be unsafe and is often disabled. This may lead to a situation where no communication between networks (e.g. via Internet) is possible.

6.4.2 Connection of the standard interface

The RJ45 connector serves for direct connecting an Ethernet cable.

- Interface: RJ45 socket, Ethernet 100BaseTX
- Mode: 10/100 MBit/s, full / half duplex, Auto-negotiation
- Protocols: http, http, Modbus/TCP, NTP

Functionality of the LED's

CU3000

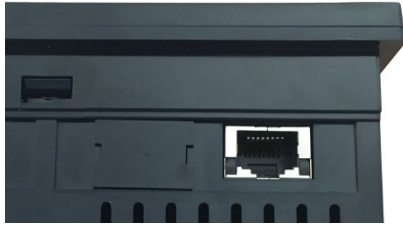

CU5000



- LED left: Switched on as soon as a network connection exists (link)
- LED right: Flashes during communication with the device (activity)

6.4.3 Connection of the IEC61850 interface

The RJ45 sockets X1 and X2 serve for direct connecting Ethernet cables. Both ports are equivalent and internally connected via a switch.

- Interface: RJ45 sockets, Ethernet 100BaseTX
- Mode: 10/100 MBit/s, full / half duplex, Auto-negotiation
- Protocols: IEC61850, NTP

Functionality of the LED's

CU3000

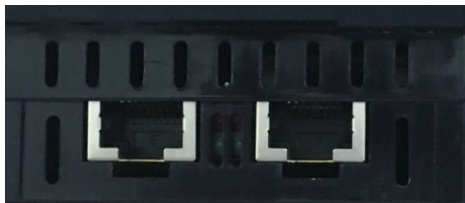

CU5000

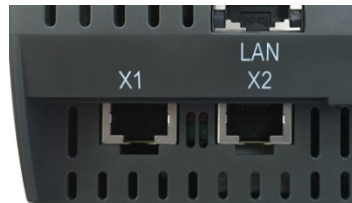

- LED green: On if a network connection (link) exists, flashes during communication

6.4.4 MAC addresses

For uniquely identifying Ethernet connections in a network, a unique MAC address is assigned to each connection. Compared to the IP address, which may be modified by the user at any time, the MAC address is static.

Standard Ethernet interface

CU3000

CU3000 - 0111 2131 00
Ord.: 000/123456/123/001
Man: 15 / 33
MAC: 00:12:34:AE:00:97



CU5000

CU5000-0111 1111 30
MAC: 00:12:34:19:00:64
Ord.: 000/123456/123
Man: 16 / 5



IEC61850 Ethernet-Schnittstelle

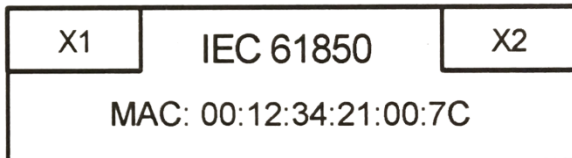

6.4.5 Communication tests

Via the service menu on the device website you may check if the selected network structure is valid. The device must be able to reach the DNS server via gateway. The DNS server then allows resolving the URL of the NTP server to an IP address. The Standard Ethernet interface serves as interface for the communication tests.

- Ping: Connection test to any network device (initial: gateway address)
- DNS: Test, if the name resolution via DNS works (initial: URL of NTP server)
- NTP: Test, if the selected NTP-Server is in fact a time server (stratum x)
- SFTP: Test, if access to SFTP server works. A test file will be copied to the base directory of the server.

| | | | | | | |
|-------------|----------------------------|---------------|------|----------|------|------|
| IPv4: Ping | 192.168.56.5 | Test | | | | |
| IPv6: Ping | fd2d:bb44:97f1:3976:5:1 | Test | | | | |
| DNS | 192.168.56.55 | 192.168.56.55 | Test | | | |
| NTP | pool.ntp.org | Test | | | | |
| SFTP server | tenserv.camillebauer.intra | 22 | data | sftpuser | | Test |

```
Testing NTP 'pool.ntp.org'
=====
server 176.10.99.200, stratum 2, offset -0.000689, delay 0.03264
server 162.159.200.123, stratum 3, offset 0.000510, delay 0.03139
server 84.16.67.12, stratum 1, offset -0.000664, delay 0.03560
server 5.148.175.134, stratum 2, offset -0.000103, delay 0.03174
23 Apr 14:29:06 ntpdate[5257]: adjust time server 84.16.67.12 offset -0.000664 sec
```

6.4.6 Resetting the communication settings of the CU5000



If the communication settings of the Standard interface are no longer known, they can be reset to the default settings by pressing the sunk-in reset button (located below the operating LED) for at least 3s. During the reset the operating LED flashes red. After the reset the device is rebooted.

6.5 IEC 61850 interface

The features of the IEC61850 interface are described in a separate document:

>> IEC61850 interface SINEAX AMx000/DM5000, LINAX PQx000, CENTRAX CUx000

This document is available via:

>> <https://www.camillebauer.com/cu3000-en> or <https://www.camillebauer.com/cu5000-en>

6.6 Security system

The device provides several security mechanisms, which can be activated to ensure a comprehensive access protection to all device data.



For devices **without data logger** the functionality of the Audit Log is restricted.
Respective restrictions are listed in the description of the individual security mechanism.

- The **role-based access control (RBAC)** system allows restricting the access to measured data, configuration settings and service functions to the rights granted to the present user. For access via website or local display this is done by reducing the available menus and / or providing only read access rights to specific services. For accessing data via external applications an API (Application Programming Interface) key is required, which needs to be implemented as a special user.
- **HTTPS** provides encrypted communication using TLS (Transport Layer Security)
- Via **client whitelist** access to the device can be restricted to specific clients with definable IP addresses.
- **Communication blocking:** Communication services, such as Modbus/RTU, Modbus/TCP or SYSLOG are blocked by default and must be actively enabled via configuration. This way unauthorized access may be prevented and possible intruding points eliminated.
- **Security log:** The device stores all security related messages in a separate list accessible via the service menu. The content of this list can also be transferred to a central log-server using the **SYSLOG** protocol for security auditing.
For devices without data logger messages get lost when restarting the device.

If the device is equipped with a display, restrictions defined in the security system also take effect when operating the device via the local display. It is also possible to restrict users to local access only.

6.6.1 RBAC management

Each access to device data via website, local display or external software applications can be comprehensively protected using the role-based access control (RBAC) system. This way, access to measured value information, the change of configuration parameters or the resetting / deletion of measurement data can be individually adapted to the role of the active user.

Note: All settings of the security system are stored in the device in encrypted form only; login credentials are never transmitted in plain text.

A maximum of 8 users is supported

- **3 pre-defined standard users**
 - *admin:* A user with administrator rights (Default setting password: „CBM_1234“)
 - *localgui:* The standard user for the local display. Its permissions determine what can be displayed or changed via the built-in display without a user having to log in.
 - *anonymous:* The standard user for access via device website. Its permissions determine what can be displayed or changed via the website without a user having to log in.

➤ **Up to 5 definable users or API keys**

Users or API keys may be created by each user with write access to the settings of the security system. In any case, each user with a web login can change the password of its own account.

Application programming interface (API) keys are used to allow applications to access device data via REST interface (communication via http/https protocol). Such keys are timely unlimited and have either read-only permissions, all permissions or all permissions except security.

The pre-defined administrator or any other user with full access rights to the settings of the security system can:

- Change its own credentials (user name and/or password)
- Change the credentials (user name and/or password) of any other user
- Freely define the permissions of the standard users *localgui* and *anonymous*; both users are standard users without login credentials
- Create new users up to a maximum of 5
- Restrict users to local operation only (no login via website)

The RBAC settings are managed via the menu Settings | Security system | Users and Permissions. To do this, Users and Permissions must be enabled:



Adding users / API keys

In addition to the 3 predefined users a maximum of 5 users or API keys may be created. To do so, use “Add user / API key” and select the type of user to be created.

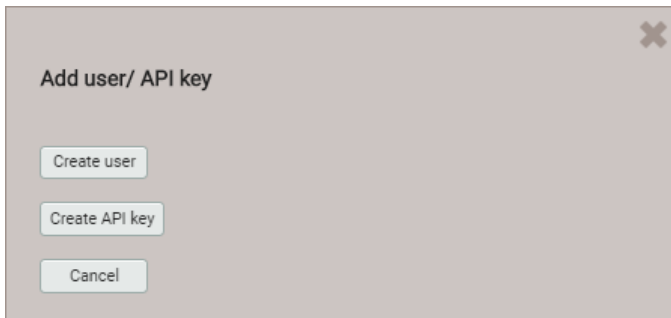

Users: During password definition the requirements for a secure password are checked and the result is displayed. Each new user can be created based on the permission template of an already existing user, but all of these permissions may be changed later.

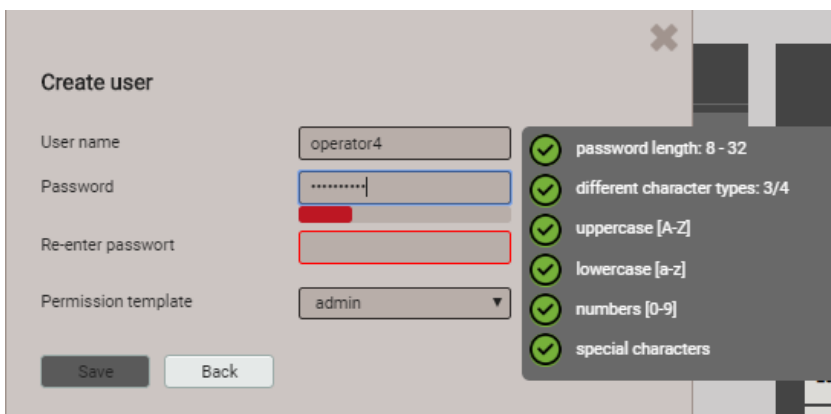

When defining / changing passwords the following restrictions must be considered:



- Password length 8 up to 32 characters
- At least three different types of characters must be used (uppercase, lowercase, numbers, special characters)



CAUTION: If login credentials (user name and / or password) of users with write access to the security system are changed, this information must be kept safe. For security reasons resetting the RBAC system can only be done at the factory, no backdoor is implemented.

API key: Along with the key name you have to define the permissions to be granted to the application using the key via REST interface. The resulting access rights cannot be changed afterwards.

Create API key

Key name: PLC_Access

Permission template: Read-only permission

Buttons: Save, Back



API key

Key: eyJhbGciOiJIUzI1NiIsInR5cCI6IkpXVCJ9.eyJhdWQiOiI0MjlmZiIsImh0bCI6MTU3OTE4ODY3OCwic3Viljoiw0FQSV1BY2Nlc3NUb2t1bilsInR4bil6IiMyOSJ9.HTbWTu7h57otuLwFPxiOy3SGmmj5At1a0NjK-ID4JA

Button: Ok

When the application wants to communicate via REST interface with the device, it has to provide the API key and the session token via the cookie field in the request header, e.g.:

Cookie:

```
AccessToken=eyJhbGciOiJIUzI1NiIsInR5cCI6IkpXVCJ9.eyJhdWQiOiI0MjlmZiIsImh0bCI6MTU3OTE4ODY3OCwic3Viljoiw0FQSV1BY2Nlc3NUb2t1bilsInR4bil6IiMyOSJ9.HTbWTu7h57otuLwFPxiOy3SGmmj5At1a0NjK-ID4JA
Jhbm9ueW1vdXMiLCJ0eG4iOiIxOTIuMTY4LjU4LjExNCJ9.LiLjuJcs2bZAmYH1vdMXTA1r87gxUX-3kZ4cfz6jdMc;
sessionToken={5d1ca47c-8d38-4a08-85d5-feFbd941fa20}
```

Further information is provided in the document "http interface SINEAX PQx000"

Assignment of user rights

The assignment of the user rights granted for operation is done via the menu Settings | Security system | Users and permissions:

| Users and Permissions | | enabled | | | | | | |
|-----------------------------|--|--------------------------|-------------------------------------|--------------------------|--------------------------|--------------------------|--------------------------|--------------------------|
| | | Add user/ API key | | | | | | |
| | | admin | localgui | anonymous | operator1 | operator2 | operator3 | [AP]AccessToken |
| Local account (no weblogin) | | <input type="checkbox"/> | <input checked="" type="checkbox"/> | <input type="checkbox"/> | <input type="checkbox"/> | <input type="checkbox"/> | <input type="checkbox"/> | <input type="checkbox"/> |
| Instantaneous values | | | | | | | | |
| Energy | | | | | | | | |
| Harmonics | | | | | | | | |
| Phasor diagram | | | | | | | | |
| Waveform | | | | | | | | |
| Events | | | | | | | | |
| PQ statistic | | | | | | | | |
| Service | | | | | | | | |
| Reset values | | | | | | | | |
| Reset/Update device | | | | | | | | |
| Audit Log | | | | | | | | |
| Use IO simulation | | | | | | | | |
| Settings | | | | | | | | |
| Basic device settings | | | | | | | | |
| Measurement | | | | | | | | |
| Communication | | | | | | | | |
| Security system | | | | | | | | |



Measurements or settings can be displayed



Measurements or settings cannot be displayed



Settings can be changed



Settings cannot be changed



Field not selectable



Change a user's login credentials



Overview of the access rights of each possible user

6.6.2 User log in / out via website

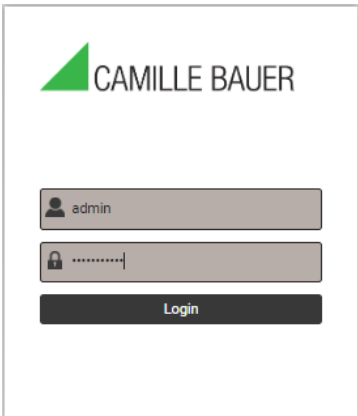

a) If “anonymous” has no granted permissions

| Via website | Remarks |
|---|--|
|  | <ol style="list-style-type: none"> 1) Enter user name and password 2) Press <ENTER> or select “Login” <p>If successful, depending on the permissions of the user logged in, the appropriate website is displayed</p> |

b) If “anonymous” has granted permissions

| Via website | Remarks |
|--|---|
|  | <ol style="list-style-type: none"> 1) Click on the symbol  2) Enter user name and password. On first login use the default settings admin / CBM_1234. 3) Press <ENTER> or select “Login” <p>If successful, depending on the permissions of the user logged in, the appropriate website is displayed</p> |

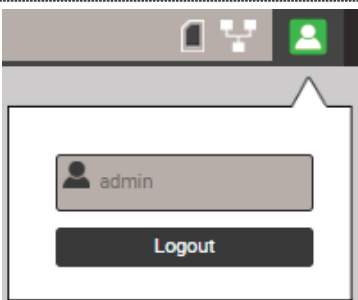
c) If another user is already logged in

| Via website | Remarks |
|---|--|
|  | <p>Log out the current user by selecting “Logout”</p> |
|  | <ol style="list-style-type: none"> 1) Click on the symbol  2) Enter user name and password 3) Press <ENTER> or select “Login” <p>If successful, depending on the permissions of the user logged in, the appropriate website is displayed</p> |

6.6.3 User log in / out via local display

a) If “localgui” has no granted permissions

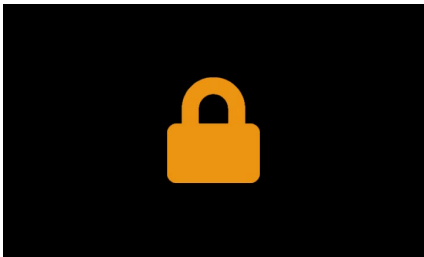
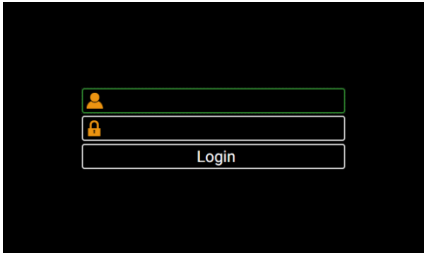
| Locally | Remarks |
|---|---|
|  | <p>No information is displayed on the screen. Press <ESC> to enter the login screen.</p> <ol style="list-style-type: none"> 1) Press <OK> to enter the user name 2) Proceed to password using ▼ 3) Press <OK> to enter the password 4) Proceed to Login and press <OK> <p>If successful, depending on the permissions of the user logged in, the appropriate menu is displayed.</p> |
|  | |

b) If localgui has granted permissions

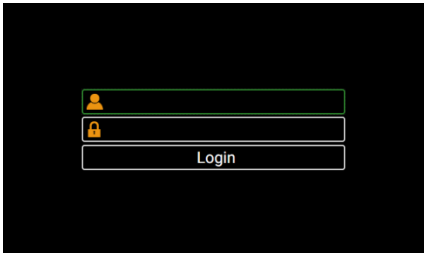
| Locally | Remarks |
|--|--|
|  | <p>Repeatedly press <ESC> until the login screen is displayed.</p> <ol style="list-style-type: none"> 1) Press <OK> to enter the user name 2) Proceed to password using ▼ 3) Press <OK> to enter the password 4) Proceed to Login and press <OK> <p>If successful, depending on the permissions of the user logged in, the appropriate menu is displayed</p> |

c) If another user is already logged in

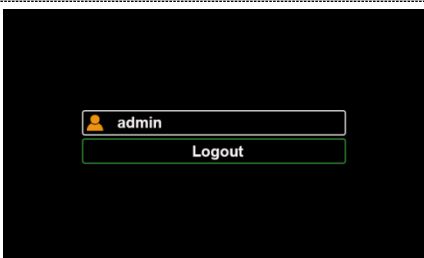
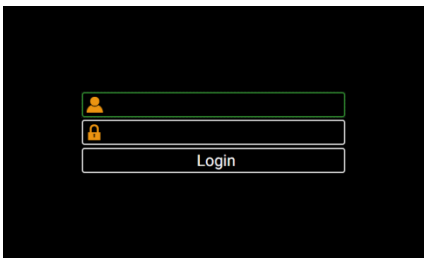
| Locally | Remarks |
|---|--|
|  | <p>Repeatedly press <ESC> until the login screen is displayed.</p> <p>Log out the current user by selecting “Logout”</p> <p>Depending on the permissions of localgui either a menu or the lock symbol is displayed</p> <p>Repeatedly press <ESC> until the login screen is displayed.</p> <ol style="list-style-type: none"> 1) Press <OK> to enter the user name 2) Proceed to password using ▼ 3) Press <OK> to enter the password 4) Proceed to Login and press <OK> <p>If successful, depending on the permissions of the user logged in, the appropriate menu is displayed.</p> |
|  | |

6.6.4 Whitelisting clients

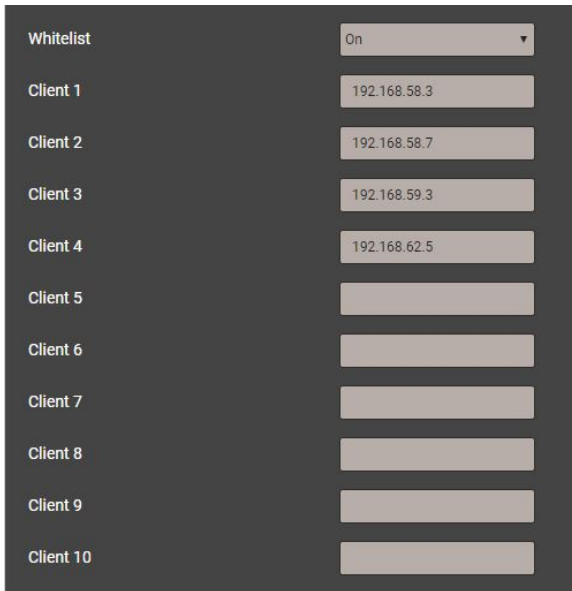

It is possible to define a list of IPv4 and/or IPv6 addresses of up to 10 clients allowed to have access to the device. All other clients will be blocked. Enable the whitelist via the *Settings* of the *Security* system in the item *Whitelist*.



If a DHCP server is used in the system, clients may get different IP addresses on each startup, losing this way access to the device.

If a device is no longer accessible you can reset its IP address (LAN), deactivating the whitelist at the same time. The whitelist may be switched off via WLAN interface as well.

6.6.5 Secure communication using https

According to Enel specifications https communication is activated by default. This protocol provides encrypted communication using TLS (Transport Layer Security). Such as bidirectional encryption of communications between a client and server protects against eavesdropping and tampering of the communication, by creating a secure channel over an insecure network.

Before HTTPS communication can be used a root certificate needs to be installed. The user can either use a Camille Bauer certificate (default setting) or its own customer certificate. This may be changed when defining the Settings of the Security system.

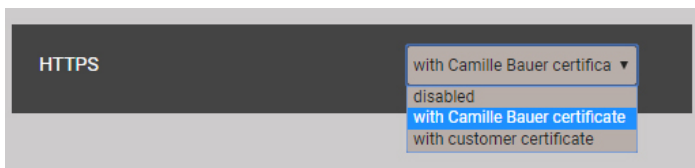

Camille Bauer certificate

Source: For example <https://www.camillebauer.com/am3000-en>

Once the certificate is downloaded to the local computer the certificate can be installed manually. Just double-click on the file. **Install certificate**, then select **Place all certificates in the following store**, **Browse** and select **Trusted Root Certification Authorities**. **Finish** the Import Wizard.

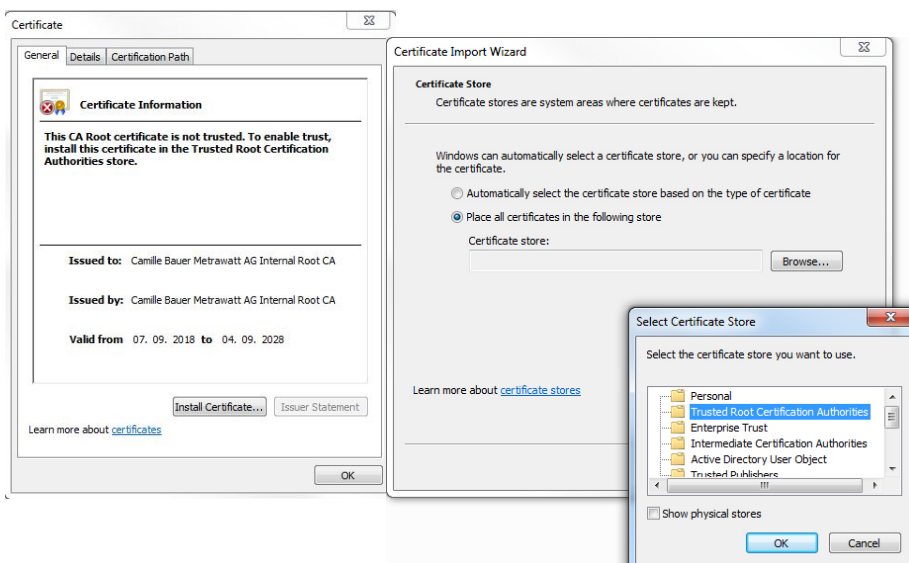

The imported certificate is valid for all devices of the PQ, AM, DM and CU series.

Agree to install the certificate if the below security warning appears:

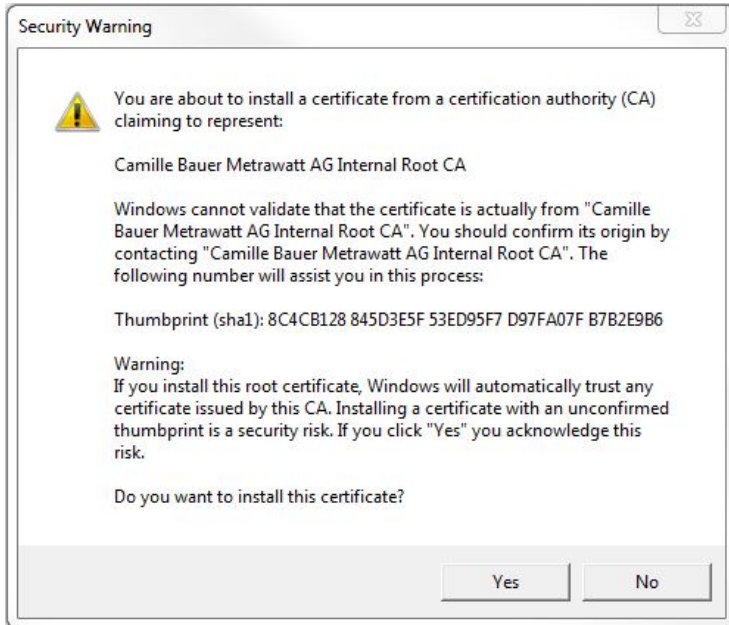

Customer certificate

You may also use a customer server certificate with a private key, but for that you first need to change the *Settings* of the *Security* system in the item *Web Security*.

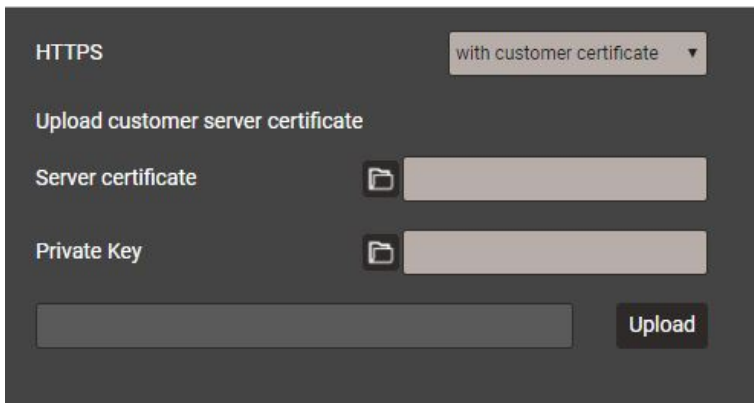

 You may use https communication also by ignoring any browser warning and establishing an **unsecure** connection to the device. However, for security reasons you should not work like that in the intended network environment.

6.6.6 Audit log (SYSLOG)

Security related events, such as ...

- a computer establishing a connection to the device
- a user logged in /out
- a failed login attempt
- each changing of the device configuration
- the view of the security log by a user
- etc.

are logged in a security log accessible via the service menu.

Results per page

Filter

| Time | PID | Priority | IP address | User name | Message |
|----------------------|-----------------|----------|---------------------|-----------|--|
| 07.02.2020, 16:44:18 | cb-gui[1523] | Notice | 192.168.57.21:58824 | admin | User logged in successfully |
| 07.02.2020, 12:00:39 | cb-pq3000[1516] | Notice | localhost | system | The device was power off Fri Feb 7 09:41:26 2020 |
| 07.02.2020, 12:00:39 | cb-pq3000[1516] | Notice | localhost | system | The device was power on Fri Feb 7 12:00:38 2020 |
| 06.02.2020, 14:25:02 | cb-gui[2117] | Info | 192.168.57.65:59614 | admin | User logged out successfully |
| 06.02.2020, 14:04:53 | cb-gui[2117] | Notice | 192.168.57.65:59378 | admin | User logged in successfully |
| 06.02.2020, 14:04:49 | cb-gui[2117] | Warning | 192.168.57.65:59378 | admin | Failed login attempt# 1 |
| 06.02.2020, 13:55:14 | cb-gui[2117] | Info | 192.168.57.65:59256 | admin | User logged out successfully |
| 06.02.2020, 13:09:26 | cb-gui[2117] | Notice | 192.168.57.65:58678 | admin | User logged in successfully |
| 06.02.2020, 12:47:47 | cb-gui[2117] | Info | 192.168.57.65:58365 | admin | User logged out successfully |
| 06.02.2020, 12:21:37 | cb-gui[2117] | Notice | 192.168.57.65:57845 | admin | User logged in successfully |

Example of a security log: The severity of each message is shown in a color code, which may also serve as filter criteria.

Each entry into this list may, if activated, also be transferred to a central log-server using the **SYSLOG** protocol for security auditing. This transfer may be performed based on UDP, TCP or TLS. The settings of the Syslog server are available via Settings | Communication | Syslog server:

| | |
|-----------------|---|
| Syslog protocol | <input type="text" value="TCP"/> |
| Host | <input type="text" value="tenserv.camillebauer.com"/> |
| Port | <input type="text" value="514"/> |

7. Operating the device

7.1 Operating elements



CU3000

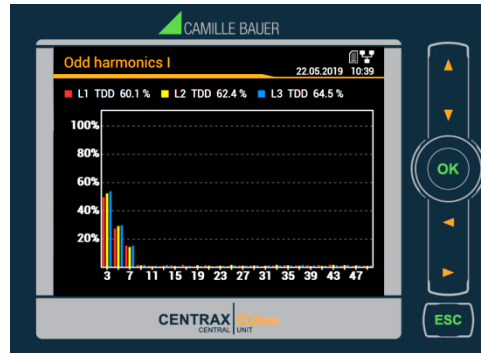

CU5000

The operation of devices with display is performed by means of 6 keys:



- OK for **selection** or confirmation
- ESC for **menu display**, terminate or cancel

The **function** of the operating keys changes in some measurement displays, during parameterization and in service functions. For the CU3000 the valid functionality of the keys is then shown in a help bar.

7.2 Selecting the information to display

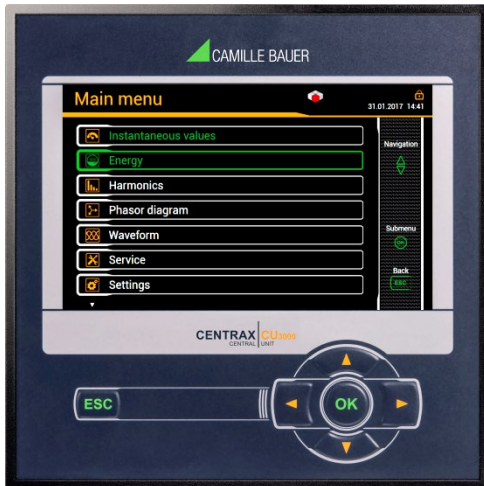

CU3000

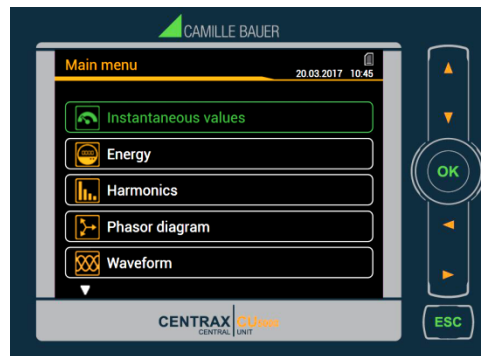

CU5000

For devices with display, information selection is performed via menu. Menu items may contain further sub-menus.

Displaying the menu

Press **ESC**. Each time the key is pressed a change to a higher menu level is performed, if present.

Displaying information



Return to measurement display

After 2 min. without interaction the menu is automatically closed and the last active measurement display is shown.

7.3 Measurement displays and used symbols

For displaying measurement information the device uses both numerical and numerical-graphical measurement displays.

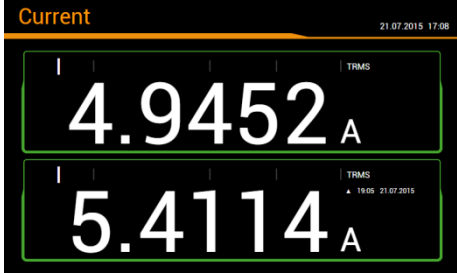
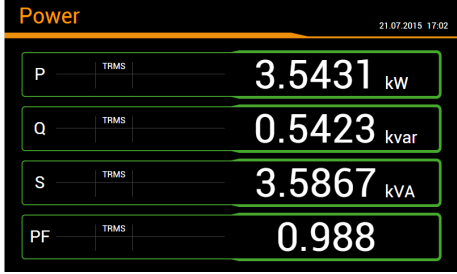
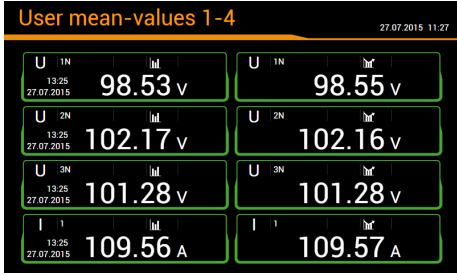
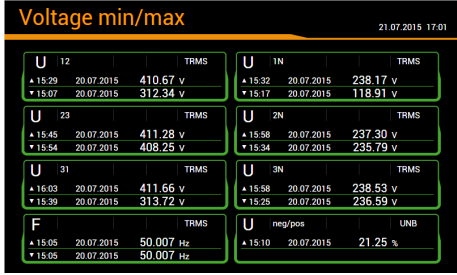
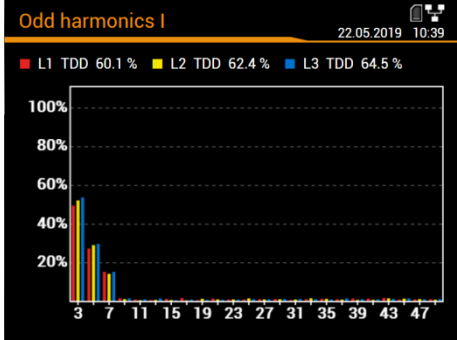
| Examples | Measurement information |
|---|---|
|  <p>The image shows a digital display titled 'Current' with a date and time of 21.07.2015 17:08. It displays two current measurements in Amperes (A) using a bar chart background. The first measurement is 4.9452 A and the second is 5.4114 A. Both are labeled as TRMS.</p> | 2 measured quantities |
|  <p>The image shows a digital display titled 'Power' with a date and time of 21.07.2015 17:02. It displays four power-related measurements: Active Power (P) 3.5431 kW, Reactive Power (Q) 0.5423 kvar, Apparent Power (S) 3.5867 kVA, and Power Factor (PF) 0.988. All are labeled as TRMS.</p> | 4 measured quantities |
|  <p>The image shows a digital display titled 'User mean-values 1-4' with a date and time of 27.07.2015 11:27. It displays eight mean values in a 2x4 grid. The first two columns show voltage (U) for phases 1N and 2N, and the last two columns show current (I) for phases 1 and 2. Values range from 98.53 V to 109.57 A.</p> | 2x4 measured quantities |
|  <p>The image shows a digital display titled 'Voltage min/max' with a date and time of 21.07.2015 17:01. It displays 2x4 values for voltage (U) and frequency (F). Each value includes a minimum and maximum range. For example, U₁₂ is 410.67 V (max) / 312.34 V (min).</p> | 2x4 measured quantities with Min/Max |
|  <p>The image shows a digital display titled 'Odd harmonics I' with a date and time of 22.05.2019 10:39. It features a bar chart showing Total Harmonic Distortion (TDD) percentages for three phases: L1 (60.1%), L2 (62.4%), and L3 (64.5%). The x-axis represents harmonic orders from 3 to 47, and the y-axis represents percentage from 0% to 100%.</p> | Graphical measurement display Further examples |

Incoming / outgoing / inductive / capacitive





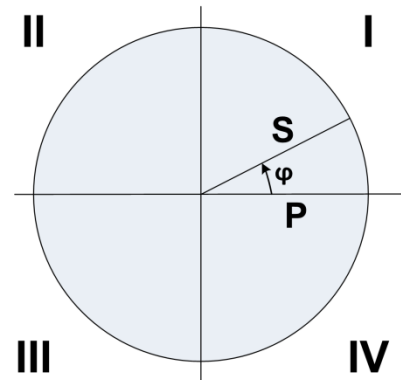

The device provides information for all four quadrants. Quadrants are normally identified using the roman numbers I, II, III and IV, as shown in the adjacent graphic. Depending on whether the system is viewed from the producer or consumer side, the interpretation of the quadrants is changing: The energy built from the active power in the quadrants I+IV can either been seen as delivered or consumed active energy.

By avoiding terms like incoming / outgoing energy and inductive or capacitive load when displaying data, an independent interpretation of the 4-quadrant information becomes possible. Instead the quadrant numbers I, II, III or IV, a combination of them or an appropriate graphical representation is used. You can select your own point of view by selecting the reference arrow system (load or generator) in the settings of the measurement.



Used symbols

For defining a measurement uniquely, a short description (e.g. U_{1N}) and a unit (e.g. V) are often not sufficient. Some measurements need further information, which is given by one of the following symbols or a combination of these symbols:

| | | | |
|---|----------------------------|-------------|--|
|  | Mean-value | ΣHT | Meter (high tariff) |
|  | Mean-value trend | ΣLT | Meter (low tariff) |
|  | Bimetal function (current) | ▲ | Maximum value |
|  | Energy quadrants I+IV | ▼ | Minimum value |
|  | Energy quadrants II+III | TRMS | True root-mean-square value |
|  | Energy quadrants I+II | RMS | Root-mean square value (e.g. fundamental or harmonic content only) |
|  | Energy quadrants III+IV | (H1) | Fundamental component only |
| I,II,III,IV | Quadrants | ∅ | Average (of RMS values) |

Examples

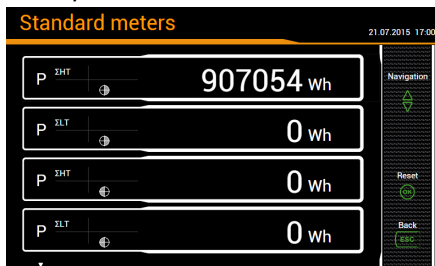

CU3000: Meters with tariff and quadrant information

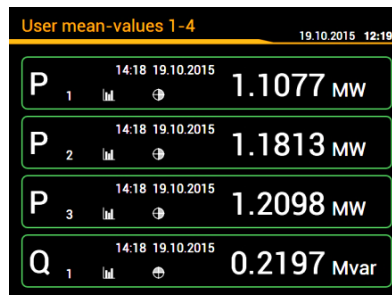

CU5000: User mean values, last value

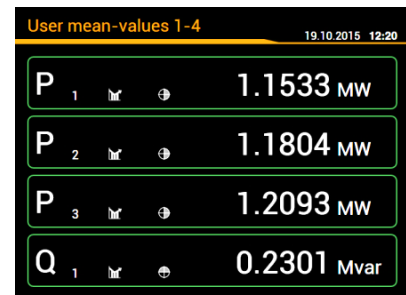

CU5000: User mean values, trend

7.4 Resetting measurement data

- **Minimum and maximum values** may be reset during operation. The reset may be performed in groups using the service menu.

| Group | Values to be reset |
|-------|---|
| 1 | Min/max values of voltages, currents and frequency |
| 2 | Min/max values of Power quantities (P,Q,Q(H1),D,S); min. load factors |
| 3 | Min/max values of power mean-values, bimetal slave pointers and free selectable mean-values |
| 4 | Maximum values of harmonic analysis: THD U/I, TDD I, individual harmonics U/I |
| 5 | All imbalance maximum values of voltage and current |

- **Meter contents** may be individually set or reset during operation using the service menu
- **Recorded logger data** can be individually reset via the service menu. This makes sense whenever the configuration of the quantities to record has been changed.

7.5 Configuration

7.5.1 Configuration at the device

With the exception of the security system a full parameterization of the device can be performed via the menu "Settings".

Modifications will not take effect before the user accepts the query "Store configuration changes" when leaving the settings menu. Changings in the "Country and clock" menu have immediate effect (e.g. a different operating language is used), but nevertheless must be stored.

- **Country and clock:** display language, date format, time zone, clock synchronization, time/date
- **Display:** Refresh rate, brightness, screen saver
- **Communication:** Settings of the [Ethernet](#) interface and the Modbus communication. In addition, a [SFTP server](#) may be defined, to push user definable data files to.
- **Measurement:** System type, sense of rotation, nominal values of U / I / f, sampling, reference arrow system etc.

Hints

- *U / I transformer: The primary to secondary ratio is used only for converting the measured secondary to primary values, so e.g. 100 / 5 is equivalent to 20 / 1. The values do not have any influence on the display format of the measurements.*
- *Nominal voltage: Is used as the 100% reference for monitoring the voltage events of the disturbance logger. It corresponds to the declared input voltage U_{din} in accordance with IEC 61000-4-30*
- *Nominal current: Used for scaling the harmonic content [TDD](#) of the currents*
- *Maximum primary values U/I: These values are used for fixing the display format of the measurements. This way you can optimize the resolution of the displayed values, because there is no dependency to installed transformers.*
- *Synchronous sampling: yes=sampling is adjusted to the measured system frequency to have a constant number of samplings per cycle; no=constant sampling based on the selected system frequency*
- *Reference channel: The measurement of the system frequency is done via the selected voltage or current input*
- **Disturbance logger:** Definition of parameters for monitoring the PQ events voltage dip, voltage interruption and voltage swell
- **Mean-values | standard quantities:** Interval time and synchronization source for the predefined power mean values
- **Mean-values | user defined quantities:** Selection of up to 12 quantities for determining their mean-values and selection of their common interval and synchronization source
- **Bimetal current:** Selection of the response time for determining [bimetal currents](#)
- **Meters | Standard meters:** Tariff switching ON/OFF, [meter resolution](#)



- **Meters | User defined meters:** Base quantities (Px,Qx,Q(H1)x,Sx,lx), Tariff switching ON/OFF, [meter resolution](#)
- **Meters | Meter logger:** Selection of the reading interval
- **Digital inputs:** Debounce time (minimum pulse width) and polarity of the [digital input](#)
- **Fault current:** Configuration of the fault current channels, especially alarm and pre-warning limits, transformer ratios as well as response and dropout delay
- **Temperature:** Configuration of the temperature monitoring channels, especially event text, alarm limits, response and dropout delay, lead resistance
- **Security system:** Definition of the [security system](#) (RBAC, https, whitelist). Locally RBAC can only be enabled or disabled, credentials and access rights must be setup via website.
- **Demo mode:** Activation of a presentation mode; measurement data will be simulated. Demo mode is automatically stopped when rebooting the device.
- **Device tag:** Definition of different texts ¹⁾, i.e. device tag, test point and device location.
- **Data export scheduler:** Via [website](#) you can setup tasks to be performed regularly. Each time such a task is running, it creates a data file to be transferred to a SFTP server and/or to be stored locally on the device. Via local configuration tasks can be enabled or disabled only.

¹⁾ In user-defined event and description texts all Unicode characters (UTF8) are allowed with the exception of the following:

- ASCII control characters (0x00 - 0x1F)
- The quotation mark " (0x22)
- The character & (0x26)
- The apostrophe ' (0x27)
- The asterisk * (0x2A)
- The slash / (0x2F)
- The colon : (0x3A)
- The «less than» character < (0x3C)
- The «bigger than» character > (0x3E)
- The question mark ? (0x3F)
- The backslash \ (0x5C)
- The vertical line | (0x7C)

At the device itself only «normal» characters of the ASCII character set can be input. Entering language specific character or texts is possible via the website of the device only.

7.5.2 Configuration via web browser

| | |
|---|--|
|  | It's recommended to use either Google-Chrome or Firefox as browser. |
|  | Internet Explorer works with limitations only (partly missing texts, firmware update not possible) |

For configuring via Webbrowser you have to display the device website using:



- IPv4 communication: `http://IPv4_addr`, e.g. `http://192.168.1.101`
- IPv6 communication: `http://[IPv6_addr]`, e.g. `http://[fd2d:bb44:97f1:3976::1]`

This request works only if device and PC are in the same network segment. Depending on the device version, there may be multiple network interfaces with different [default IP addresses](#).

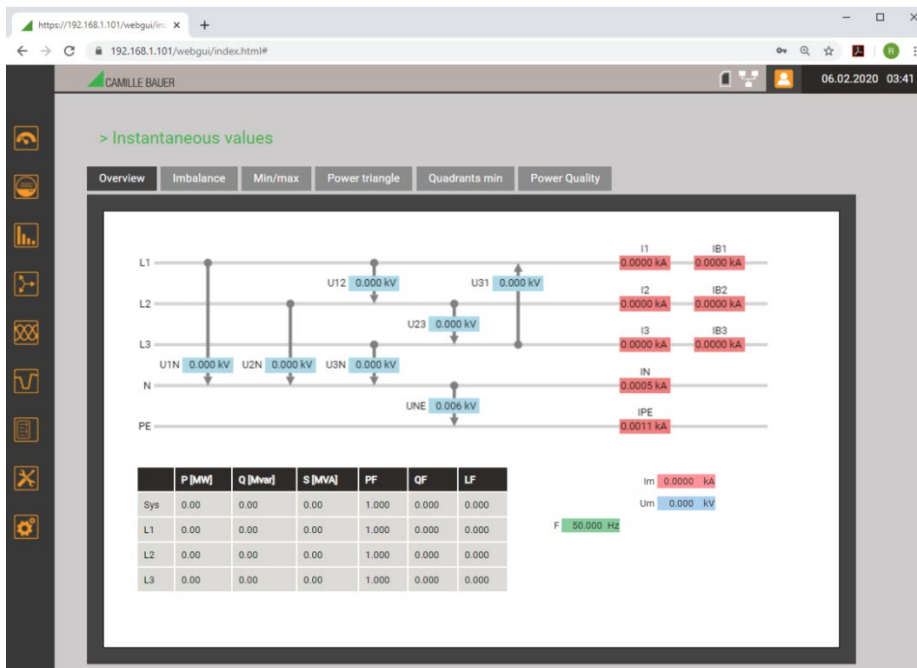
If the [secure communication via https](#) is activated and the root certificate installed, you have to use https instead of http for displaying the website

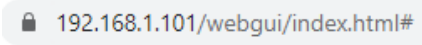

Device website using Google Chrome

| | |
|---|--|
|  | The lock symbol shows that a secure connection is established (if https is used) |
|  | There are three information here: <ul style="list-style-type: none"> • The SD-card is present and stores data • A network connection is established • User and permissions management is active, but no user is logged in so far. |

 Via WEB-GUI you can make the same settings as via the [local GUI](#) using the Settings menu. In addition, it is possible to setup the [security system](#) and the [Data export scheduler](#) and to enter user-defined event or description texts in UTF8 format.

Possibly modifications need to be saved in the device, before all parameters have been set. In such a case the following message appears:

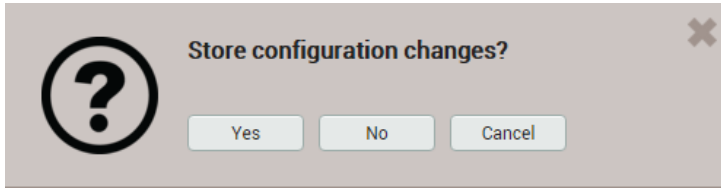



If this request is not confirmed unsaved modifications of the present device configuration may get lost.

Loading / saving configuration files

The user can save the present device configuration on a storage media and reload it from there. The storage or load procedure varies depending on the used browser.

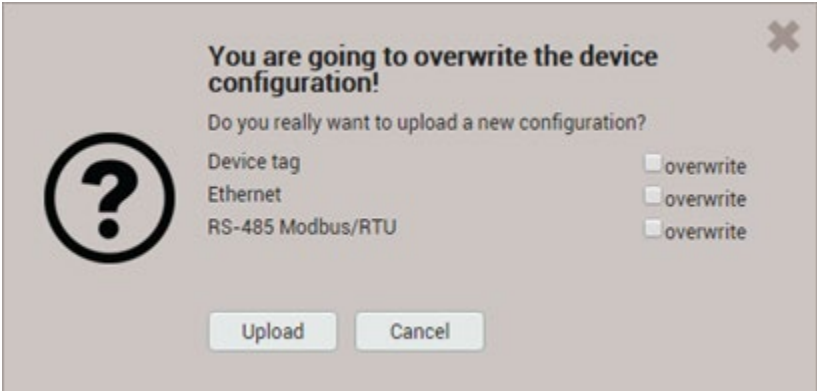
 **The settings of the security system are not part of the configuration file. There is no way for transferring security settings from one device to another.**

| | |
|---|--|
|  | <p>Loading a configuration file from a storage media</p> <p>The configuration data of the selected file will be directly loaded into the device. The values in the WEB-GUI will be updated accordingly. Normally devices differ in the settings of network or Modbus parameters and device name. Thus when loading the file you can choose, whether the appropriate settings of the device should be retained or overwritten by the values in the file to be uploaded.</p> <div style="text-align: center;">  </div> |
|  | <p>Storing the current parameter settings of the WEB-GUI into the device</p> |
|  | <p>Saving the device configuration to a storage media</p> <p>Attention: Modifications in the WEB-GUI, which haven't been stored in the device, will not be written to the storage media.</p> |

7.6 Monitoring and alarming

7.6.1 Monitoring fault-currents

Each (optional) fault current module provides **two channels** for monitoring residual or fault current. For each of the channels an alarm and a pre-warning limit can be defined, which can be used as follows:

- ... Activating a [summary alarm](#) when the alarm limit is violated or a breakage occurs (2mA input only)
- ... Entry into the alarm list, if the state of the alarm limits monitoring changes or when a breakage occurs (2mA input only)
- ... Entry into the event list, if the state of the pre-warning limits monitoring changes

And via PLC application:

- ... as source for digital outputs
- ... the value of the individual fault currents can also be output via the analog outputs

The present values of the monitored fault currents are visible via the menu of the instantaneous values:

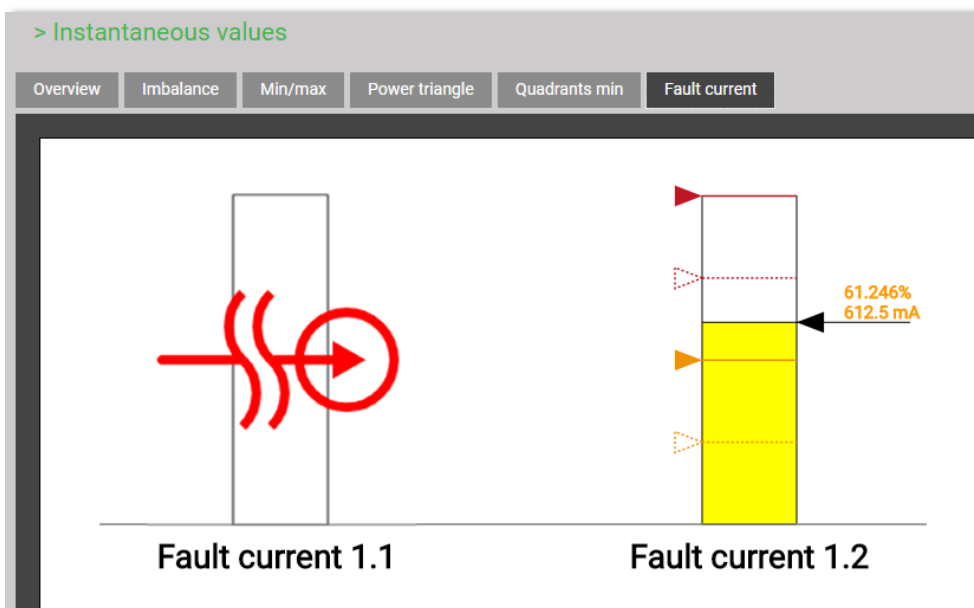

Meaning of the used symbols

| | |
|--|---------------------------------------|
| | Current value normal |
| | Pre-warning limit violated |
| | Alarm limit violated |
| | Alarm: Configured limit for ON |
| | Alarm: Configured limit for OFF |
| | Pre-warning: Configured limit for ON |
| | Pre-warning: Configured limit for OFF |
| | Breakage of measurement line detected |

7.6.2 Temperature monitoring

Each (optional) temperature module provides **two channels** for temperature monitoring.

Used for Pt100 measurement

- Up to 2 limit values
- Short circuit and wire / sensor breakage monitoring

Used for PTC monitoring

- Monitoring the PTC response temperature
- Short circuit monitoring

Usage of the determined states

- ... Activating a [summary alarm](#) when an alarm limit is violated (Pt100) or the response temperature is reached (PTC), a short-circuit or a wire / sensor breakage (Pt100) occurs
- ... as logic input for [monitoring functions](#)
- ... Entry into the alarm list when any state change occurs

And via PLC application:

- ... as source for digital outputs
- ... the present temperature for Pt100 measurement can also be output via the analog outputs

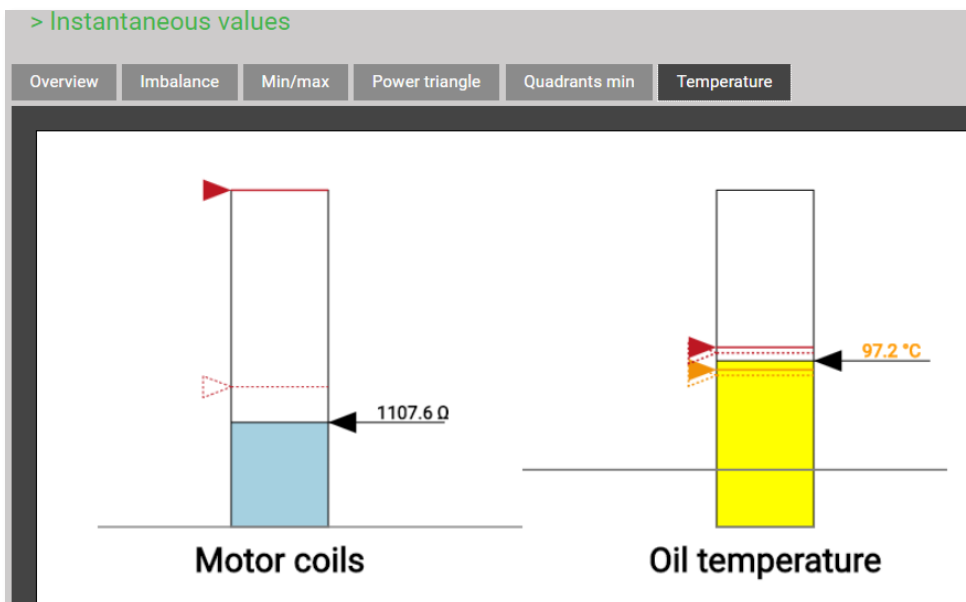

State of temperature monitoring in the instantaneous values menu, PTC on the left, Pt100 on the right

Meaning of the used symbols

| | |
|--|-----------------------------------|
| | Measurement in the normal range |
| | Alarm limit 1 violated |
| | Alarm limit 1 violated |
| | Alarm 2: Configured limit for ON |
| | Alarm 2: Configured limit for OFF |
| | Alarm 1: Configured limit for ON |
| | Alarm 1: Configured limit for OFF |
| | Wire / sensor breakage detected |
| | Short-circuit detected |

7.6.3 Summary alarm

The summary alarm combines the states of all channels of the (optional) failure-current and temperature monitoring. If either an alarm state, a short-circuit (measurement with Pt100, PTC) or a wire / sensor breakage (2mA inputs, Pt100 measurement) is detected the summary alarm is directly activated.



Device with RCM module: Alarm via local GUI

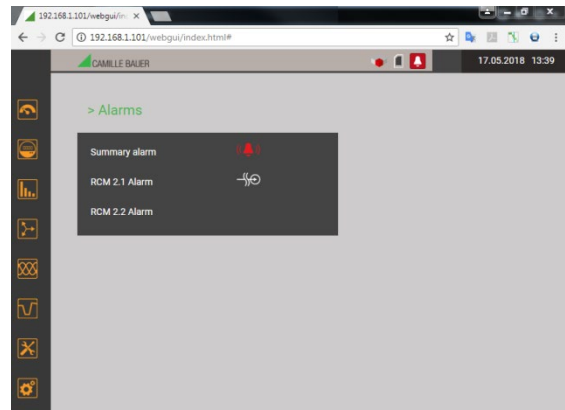

Device with RCM module: Alarm via WEB-GUI



The symbol arranged in the status bar signals active alarms.





Acknowledgment: By acknowledging the summary alarm, the user confirms that he has recognized that an alarm state occurred. The acknowledgment is done automatically as soon as the user selects the alarm list to be displayed either locally or via web browser or if the alarm state no longer exists. By acknowledging only the flashing of the alarm symbol stops, the symbol itself remains statically displayed until none of the fault current channels is in the alarm state.

7.7 Data recording

The optional data logger provides long-term recordings of measurement progressions and events.

In addition, file based information can periodically be created using the [data export scheduler](#). Such data can be stored internally and / or securely sent to a SFTP server.

The recording is performed in endless mode (oldest data will be deleted, as soon as the associated memory is used for more than 80%).

| Group | Data type | Request | |
|---------------------------------|--|--|---|
| Periodic data | <ul style="list-style-type: none"> • Mean-values versus time • Periodic meter readings |  Energy | <ul style="list-style-type: none"> • Mean value logger • Meter logger |
| Events | In Form of a logbook with time information: <ul style="list-style-type: none"> • Event list: Each violation of the pre-warning level of the (optional) fault current channels • Alarm list: Each violation of the alarm limits of the (optional) fault current channels • Temperature alarm list: Each violation of the limit values of the (optional) temperature channels |  Events | <ul style="list-style-type: none"> • Event and alarm list |
| Disturbance recorder | Events will be registered in the disturbance recorder list. By selecting the entries: <ul style="list-style-type: none"> • the course of the RMS values of all U/I • the wave shape of all U/I during the disturbance will be recorded |  Events | <ul style="list-style-type: none"> • Disturbance recorder |
| Security events | <ul style="list-style-type: none"> • Security log (SYSLOG) |  Service | <ul style="list-style-type: none"> • Log of the security system |

7.7.1 Periodical data

Configuration of the periodic data recording

Via the settings menu the user can individually configure:

- The averaging interval of the standard mean-values P(I+IV), P(II+III), Q(I+II), Q (III+IV), S
- The averaging interval of up to 12 user-defined mean-values
- The reading interval of standard meters P(I+IV), P(II+III), Q(I+II), Q (III+IV)
- The reading interval of up to 12 user-defined meters

The recording of all mean-values and meters is started automatically on device start. The recording of the mean-values is done when the appropriate averaging interval expires.

Displaying the chronology of the mean values

The chronology of the mean values is available via the menu **Energy** and is divided in two groups:

- Pre-defined power mean values
- User-defined mean values

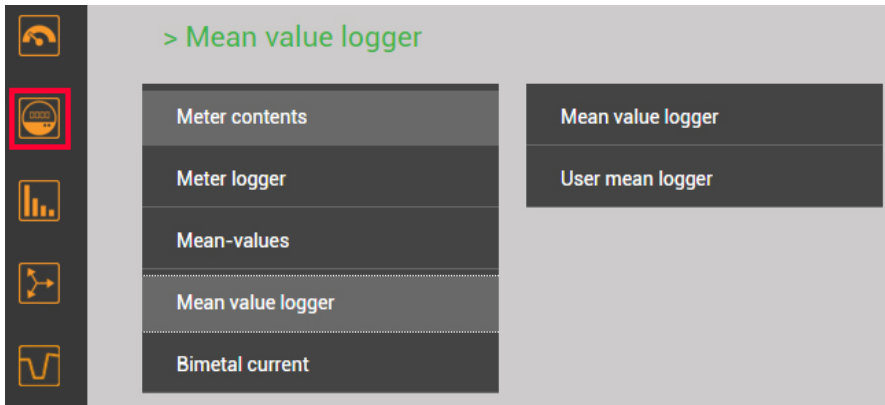

Selection of the mean values group



The selection of the mean-value quantity to display can be performed via choosing the corresponding register. Three different kind of displays are supported:

- Daily profile: Hourly mean-values will be shown, independently of the real averaging time
- Weekly profile
- Table: Listing of all acquired mean-values in the sequence of the real averaging interval

The graphical representation allows to compare directly the values of the previous day or week.



By selecting the bars you may read the associated values:

- Mean-value
- Min. RMS value within the interval
- Max. RMS value within the interval



Weekly display



Weekly display: Reading

> Mean value logger

Log P (I+IV) | Log P (II+III) | Log Q (I+II) | Log Q (III+IV) | Log S

Day | Week | Table

«Previous 1 2 3 4 5 Next» Results per page 25

| # | time | mean | min(Interval) | max(Interval) |
|----|--------------------------|----------|---------------|---------------|
| 1 | 14.06.2016, 14:33:00.000 | 78.89 kW | 65.75 kW | 109.42 kW |
| 2 | 14.06.2016, 14:32:00.000 | 93.65 kW | 74.96 kW | 125.97 kW |
| 3 | 14.06.2016, 14:31:00.000 | 86.42 kW | 74.48 kW | 104.89 kW |
| 4 | 14.06.2016, 14:30:00.000 | 80.17 kW | 67.36 kW | 106.59 kW |
| 5 | 14.06.2016, 14:29:00.000 | 88.62 kW | 75.01 kW | 111.77 kW |
| 6 | 14.06.2016, 14:28:00.000 | 80.96 kW | 69.96 kW | 116.12 kW |
| 7 | 14.06.2016, 14:27:00.000 | 87.96 kW | 68.81 kW | 108.47 kW |
| 8 | 14.06.2016, 14:26:00.000 | 80.98 kW | 69.05 kW | 102.54 kW |
| 9 | 14.06.2016, 14:25:00.000 | 88.52 kW | 68.12 kW | 123.43 kW |
| 10 | 14.06.2016, 14:24:00.000 | 87.96 kW | 70.60 kW | 104.98 kW |

Mean values in table format

Displaying the chronology of meter contents

The chronology of meters is available via the menu **Energy** and is divided in two groups:

- Pre-defined meters
- User-defined meters

From the difference of two successive meter readings the energy consumption for the dedicated time range can be determined.

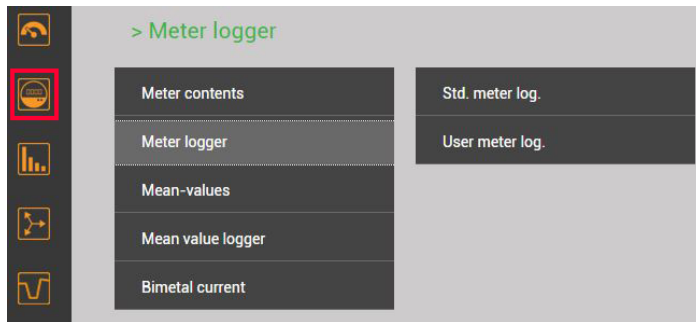

Selection of the meter logger group

> Std. meter log.

Log ΣP(I+IV) | Log ΣP(II+III) | Log ΣQ(I+II) | Log ΣQ(III+IV)

«Previous 1 2 3 4 5 Next» Results per page 25

| # | time | ΣP(I+IV), ΣII | ΣP(I+IV), ΣIII |
|----|--------------------------|---------------|----------------|
| 1 | 15.06.2016, 14:00:00.000 | 0 kWh | 33276.80 kWh |
| 2 | 15.06.2016, 13:00:00.000 | 0 kWh | 33203.10 kWh |
| 3 | 15.06.2016, 12:00:00.000 | 0 kWh | 33137.40 kWh |
| 4 | 15.06.2016, 11:00:00.000 | 0 kWh | 33069.10 kWh |
| 5 | 15.06.2016, 10:00:00.000 | 0 kWh | 32996 kWh |
| 6 | 15.06.2016, 09:00:00.000 | 0 kWh | 32919.70 kWh |
| 7 | 15.06.2016, 08:00:00.000 | 0 kWh | 32849.90 kWh |
| 8 | 15.06.2016, 07:00:00.000 | 0 kWh | 32784 kWh |
| 9 | 15.06.2016, 06:00:00.000 | 0 kWh | 32735.30 kWh |
| 10 | 15.06.2016, 05:00:00.000 | 0 kWh | 32719.10 kWh |
| 11 | 15.06.2016, 04:00:00.000 | 0 kWh | 32687.10 kWh |

Meter content readings in table form

Displaying data locally

The selection works in principle in the same way as with the WEB-GUI. There are the following differences:

- The individual measured quantities are arranged in a display matrix and can be selected via navigation.
- The number of displayable meter readings is limited to 25
- The time range of the mean values is limited to the present day or the present week. There is no possibility for navigation.

Data export as CSV file



Via  the time range of the data to export can be selected. A CSV (Comma separated value) file will be generated. This can be imported as a text file to Excel, with comma as a separator.

The same file contains data for all quantities of the respective group.

7.7.2 User-defined events

Configuration of events

Events of the (optional) fault-current and temperature channels are automatically entered into the appropriate lists. The limit values to be monitored can be defined via the items Temperature and Fault current in the settings menu.

- Event list: Each violation of the pre-warning level of the (optional) fault current channels
- Alarm list: Each violation of the alarm limits of the (optional) fault current channels
- Temperature alarm list: Each violation of the limit values of the (optional) temperature channels

Displaying of event entries

Event lists are a kind of logbook. Every state transition of monitored events is recorded in the appropriate list with the time of its occurrence.

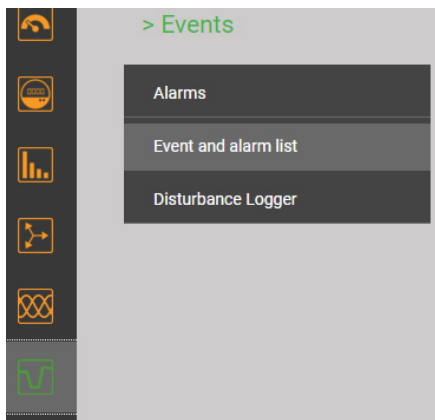

| # | time | text | state |
|---|--------------------------|-----------------|-------|
| 1 | 18.03.2020, 10:48:52,485 | RCM 1.2 Warning | ↘ |
| 2 | 18.03.2020, 10:48:52,385 | RCM 1.2 Warning | ↘ |
| 3 | 18.03.2020, 10:47:50,727 | RCM 1.1 Warning | ↘ |
| 4 | 18.03.2020, 10:47:50,326 | RCM 1.1 Warning | ↘ |

Example of an event list

Displaying data locally

The selection works in principle in the same way as with the WEB-GUI. There is the following difference:

- The number of displayable events is limited to 25

7.7.3 Disturbance recorder

Configuration of the events to record

The device monitors the events voltage dip, swell and interruption. The user can define the threshold levels for these events in the menu **Settings | Disturbance Logger**.

Display of disturbance recordings (locally)

Recorded disturbances are available in the form of a logbook. Each detected disturbance is entered into the disturbance recorder list with the time of its occurrence. By selecting a list entry the graphical display of the measured values during this event is entered. The following presentations are available:

- Half cycle RMS curves of all voltages, all currents, all voltages and currents
- Wave shapes of all voltages, all currents, all voltages and currents

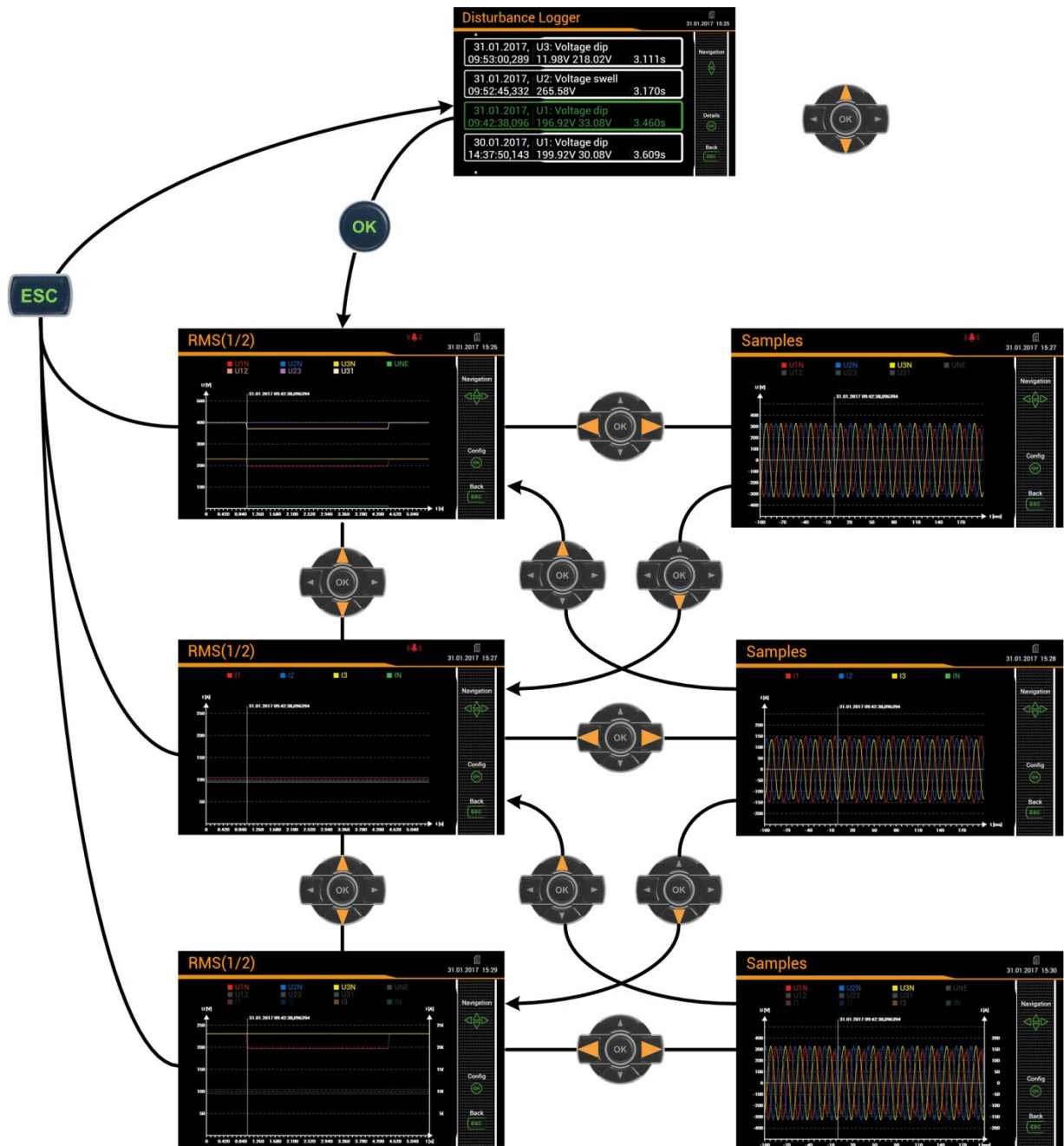

Display matrix on the local display

Restriction of the quantities to display on the local display

The user can adapt the displayed information to its needs. Once the graphic is displayed, the setting window for the selection of the quantities to display is entered by pressing <OK>.

Spannungsanzeige

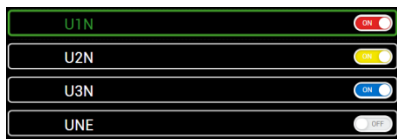

Stromanzeige

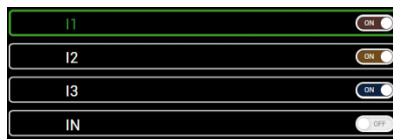

Gemischte Anzeige

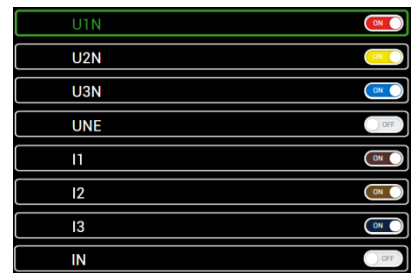

Display of disturbance recordings (WEB-GUI)

As with the local GUI, recorded disturbances are available in the form of a logbook. By selecting a list entry the graphical display of the measured values during this event is entered. By selecting a time range via left mouse key, the graphical event display may be zoomed.

Disturbance Logger

Navigation: < < 1 > >> Results per page: 25

| # | time | Trigger channel | Event type | Event value | Event value | Duration [s] |
|---|--------------------------|-----------------|---------------|------------------------------|------------------|--------------|
| 1 | 22.09.2020, 13:59:13,574 | U3 | Voltage dip | Residual voltage: 0.003 kV | Depth: 11.497 kV | 3.531 |
| 2 | 22.09.2020, 13:59:07,587 | U2 | Voltage swell | Maximum magnitude: 13.558 kV | | 3.320 |
| 3 | 22.09.2020, 13:58:55,068 | U1 | Voltage dip | Residual voltage: 6.007 kV | Depth: 5.493 kV | 5.261 |
| 4 | 22.09.2020, 13:57:24,138 | U2, U3 | Voltage dip | Residual voltage: 6.920 kV | Depth: 4.580 kV | 0.033 |
| 5 | 22.09.2020, 13:57:23,898 | U2, U3 | Voltage dip | Residual voltage: 4.388 kV | Depth: 7.112 kV | 0.035 |

List of disturbance recordings



Graphical display of a disturbance recording



Zoomed disturbance recording

7.7.4 Micro SD card (CU3000 only)

Devices with data logger are supplied with a micro SD-Card, which provides long recording times.

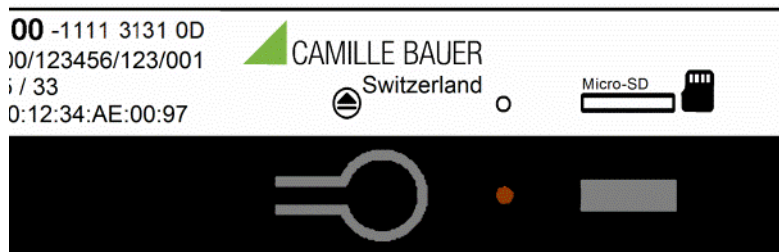

Activity

The red LED located next to the SD card signals the logger activity. When data is written to the SD card the LED becomes shortly dark.

Exchanging the card

For exchanging the SD card the removal key needs to be pressed. Once the LED becomes green the card is logged off and can be removed. To remove the card, press it slightly into the device to release the locking mechanism: The card is pushed out of the device.

If the SD card is not removed within 20s the exchanging procedure is cancelled and the card will be mounted to the system again.

Data cannot be temporarily stored in the device. If there is no SD card in the device no recordings can be done.



Data stored on the SD card can be accessed only as long as the card is in the device. Stored data may be read and analyzed via the webpage of the device or in reduced manner via display only. The content of the SD card cannot be read using a Windows PC.

Thus before removing the SD card from the device, all data need to be read via Ethernet interface.

7.8 Measurement information in file format

Using the data export scheduler, measurement information may be provided also in file format. Such files can then:

- periodically being sent to an SFTP server
- locally stored in the device and downloaded via webpage

7.8.1 Creating periodic file data

A periodic generation of CSV files can be setup using the Data export scheduler via the menu Settings | Data export. For this tasks may be defined for creating data files with a specific content at regular intervals. These files may be stored locally and / or pushed to a SFTP server.

By selecting “Add task” new schedules can be set-up. An example is shown below:

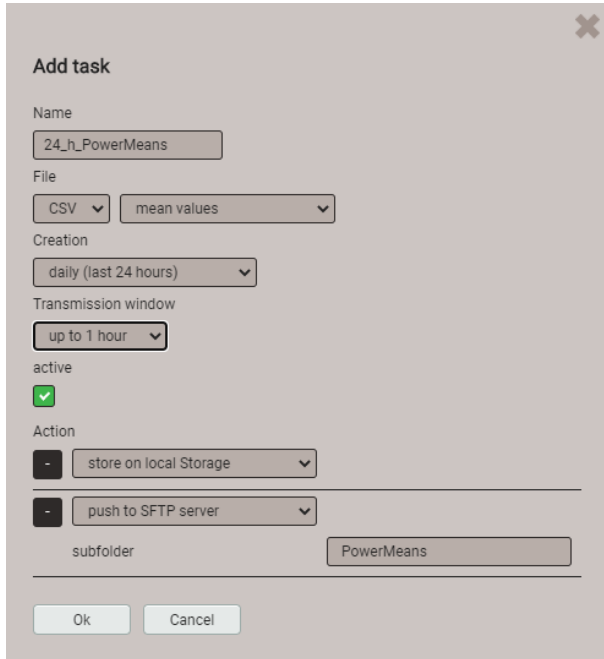

The new task “24_h_PowerMeans” will generate daily CSV files containing standard mean-values for the past 24 hours.

The files will be both stored locally and pushed to the subfolder PowerMeans of a SFTP server. The [settings](#) of the SFTP server to be used can be defined via Communication | SFTP in the Settings menu.

The transmission window selected here causes a random transmission of the file to the SFTP server within one hour since creation.

At any time the newly created task “24_h_PowerMeans” can be fully modified, deactivated or deleted.

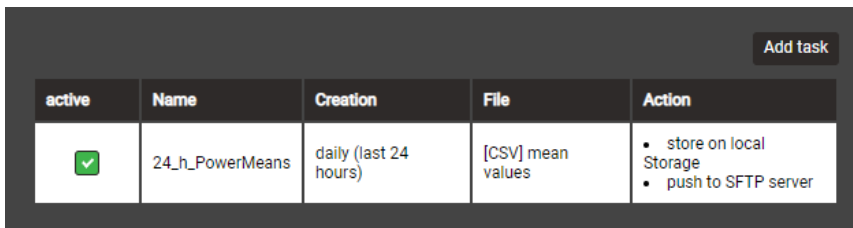

| active | Name | Creation | File | Action |
|-------------------------------------|-----------------|-----------------------|-------------------|--|
| <input checked="" type="checkbox"/> | 24_h_PowerMeans | daily (last 24 hours) | [CSV] mean values | <ul style="list-style-type: none">• store on local Storage• push to SFTP server |

Via the menu Settings | Data export | Data export scheduler on the local display tasks can only be activated or deactivated.

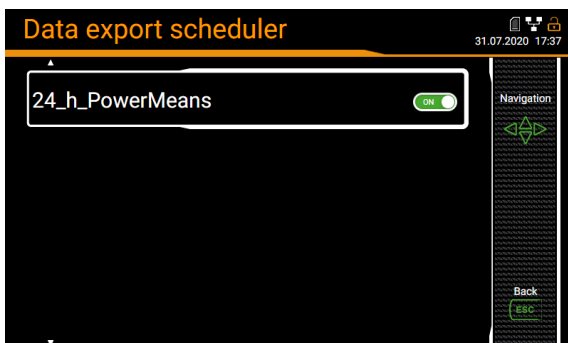

CSV settings

CSV files are intended for transmitting statistics of mean values. You may adjust the below parameters to adapt the file format and the content of the created files to your requirements.

| | |
|----------------------------|----------------|
| Separator | Semicolon |
| Decimal separator | Dot |
| Time format | Local time +AB |
| include min/max values | Yes |
| Scaled to... | Nominal values |
| Digits after decimal point | 3 |

- The **Separator** separates the individual entries on a text line for later display in table form.
- The **Decimal separator** defines how numbers or measured values are written to the file. The decimal separator must correspond to the country-specific number format of the operating system so that the CSV file can be opened directly in Excel without an import process. Common separators are periods (123.45) or commas (123,45).
- **Time format** defines the time format to be written. With the “local time + AB” time format, the double entries between 2 and 3 AM are supplemented with the letters A and B when switching back from daylight saving time.
- **Include min/max values** defines whether mean values with / without minimum and maximum values are written to the CSV file.
- **Scaled to** specifies whether the numerical value is based on the basic unit (e.g. 1087.65W) or on the units specified according to the nominal values (e.g. 1.0876kW), which are also used in the web interface.
- **Digits after decimal point** defines the number of digits after the decimal separator with which the numbers are written to the file.

7.8.2 Accessing file information via webpage

You can access files stored in the device using the service menu **Local data storage | Download data**.

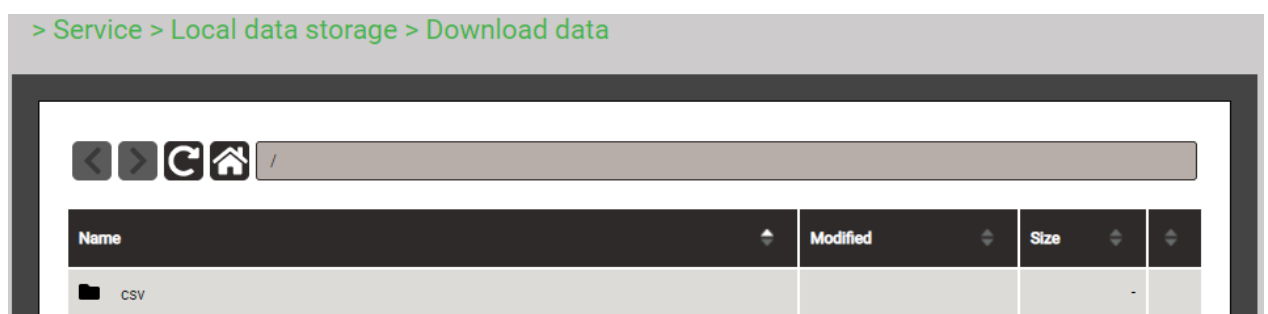

7.8.3 Periodical sending to a SFTP Server

If in the data export scheduler the sending to an SFTP server was selected as action, the appropriate files will be sent periodically to the SFTP server defined in the settings of the communication.

| | |
|------------------------------|----------------------------|
| Host | tenserv.camillebauer.intra |
| Port | 22 |
| Username | sftpuser |
| Password | copy |
| Base directory | data |
| Only connect to trusted host | No |

For improving security you may select that the device connects to trusted hosts only. When activating this setting the host must be present and sends a public key back to the device. If you accept this key the associated host will be added to the list of trusted servers.

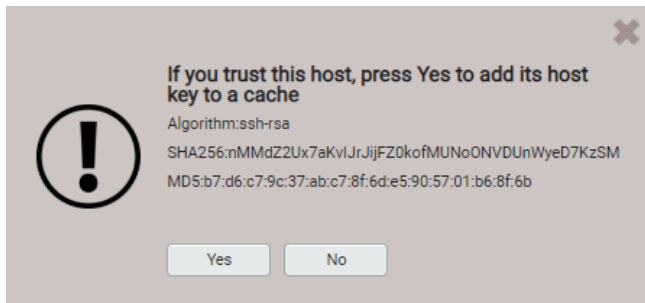

7.9 Timeouts

Devices with display are designed for displaying measurements. So, any other procedure will be terminated after a certain time without user interaction and the last active measurement image will be shown again.

Menu timeout

A menu timeout takes effect after 2 min. without changing the present menu selection. It doesn't matter if the currently displayed menu is the main menu or a sub-menu: The menu is closed and the last active measurement image is displayed again.

Configuration timeout

After 5 min. without interaction in a parameter selection or during entering a value in the settings menu, the active configuration step is closed and the associated parameter remains unchanged. The next step depends on what you have done before:

- If the user did not change configuration parameters before the aborted step, the main menu will be displayed and the device starts to monitor a possible menu timeout.
- If the user changed configuration parameters before the aborted step, the query "Store configuration changes?" is shown. If the user does not answer this query within 2 min. this dialogue is closed: The changed configuration will be stored and activated and then the last active measurement image is displayed again.

8. CODESYS Quick Start

CODESYS is a hardware independent developing environment which can be used to create control applications on a target system (here CENTRAX CUx000). For creating the application any of the programming languages according IEC 61131-3 can be used.

A detailed description of CODESYS is available via the help menu inside the developing environment. The following information is a brief introduction to the operation of CODESYS.

8.1 CODESYS development environment

In order to be able to use the control functionality of the devices of the CENTRAX series the CODESYS development environment is required. This can be downloaded free of charge from our homepage

<https://www.camillebauer.com/cu3000-en> or <https://www.camillebauer.com/cu5000-en>

in a version tested with the devices. All necessary licenses are stored in the hardware and are therefore included in the scope of supply.

- **Install the CODESYS development environment on your PC**

8.2 CENTRAX device description

For CENTRAX devices to be used in the development environment as a hardware resource or target platform, it is necessary to install a corresponding device description file. This file describes the possibilities of the device. Once it is installed, CENTRAX devices are available in the device list and their functionality can be used.

The device description can directly be downloaded from the device using its webpage. To do so, enter the IP address of the device in your browser, e.g. 192.168.62.214 as shown below. The device description can be downloaded via the service menu using **CODESYS → Download**. The file is stored in the folder **package/**. Alternatively the file can also be downloaded from our website

<https://www.camillebauer.com/cu3000-en> or <https://www.camillebauer.com/cu5000-en>.

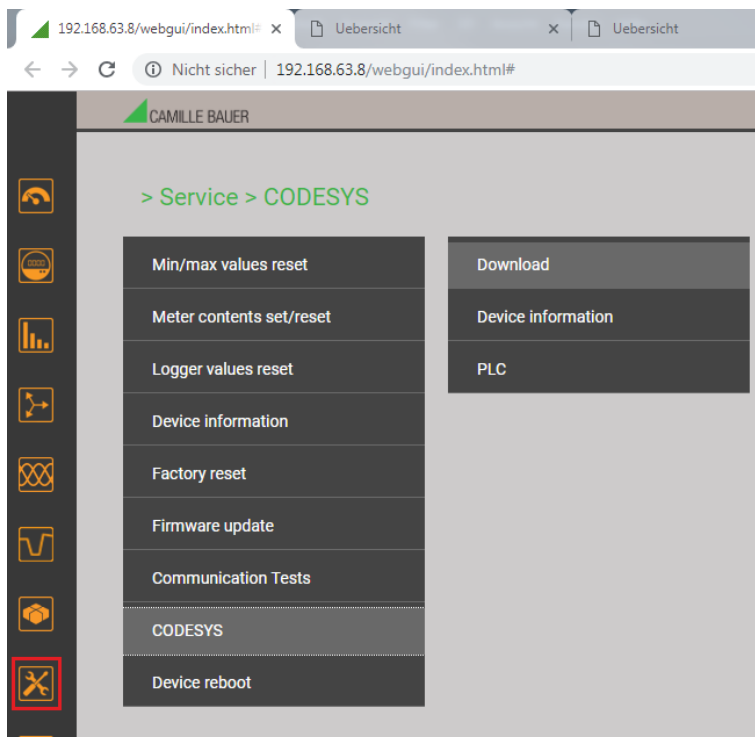

The device description can then be installed in two ways.

- Double click on the device description file CENTRAX_CUx000_<version>.package
The prerequisite is the installed CODESYS development environment and sufficient user rights.
- Via Tools | Package Manager in the CODESYS development environment
You may need to run the CODESYS development environment with administrative privileges.

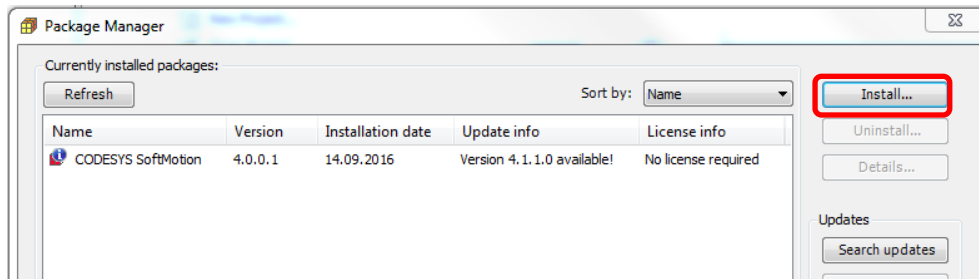

8.3 Create a project

a) File | New Project →

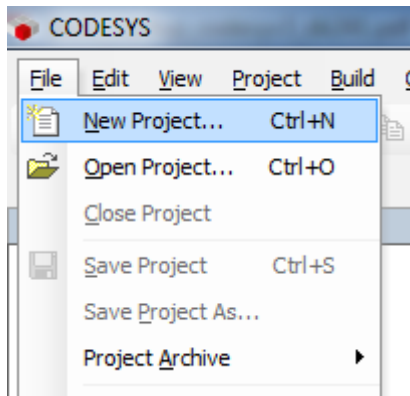

Standard project

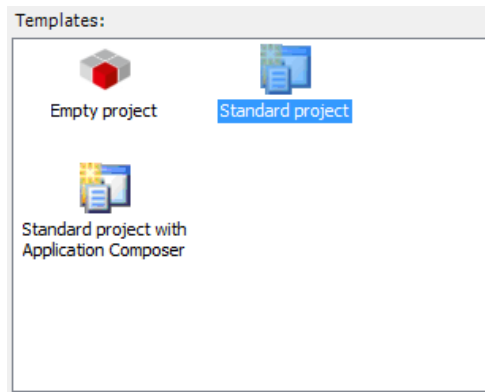

- b) Next to **Device** select the performance class (Basic, Advanced, Professional) of the target device, e.g. CU3000/CU5000 Basic, at **PLC_PRG** select the programming language to be used for creating the application.

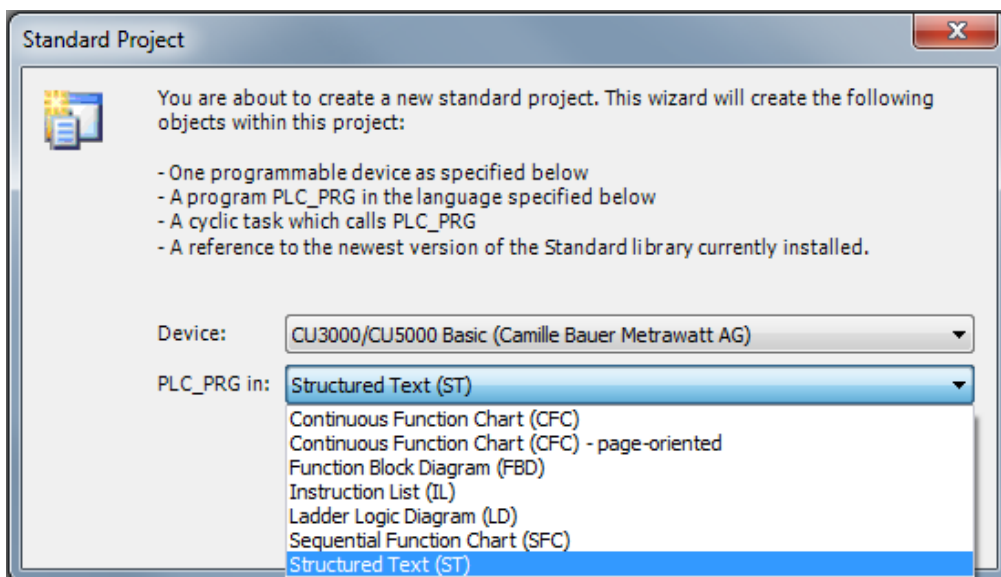

8.4 CU3000/CU5000 Device tree

The new created project is now visible on the left side of the main window. The device tree contains the application **1**, the measurement image **2**, the input and outputs **3** and an additional Modbus image **4**.

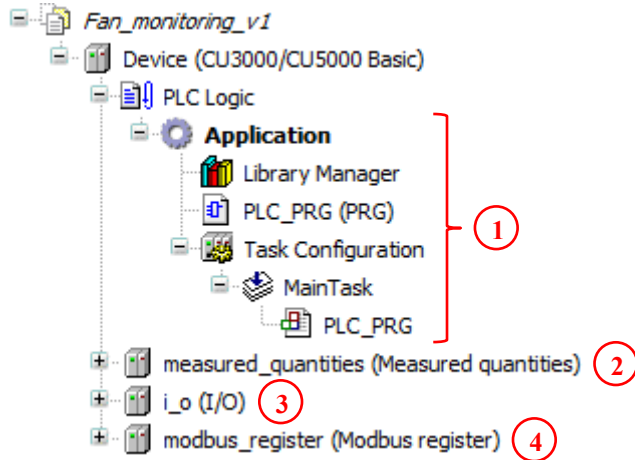

8.5 Selection of the I/O extension modules

The I/O options can vary depending on the device version ordered. So, before the corresponding I/O channels can be used by the control application they have to be selected.

The options need to be configured in the device tree of the project via **I/O → option x**. For a CU3000 all I/O options may be assigned, for a CU5000 option 1 and 2 only. Right click on the field **<Empty>** and select **Plug Device** to open the appropriate configuration window.

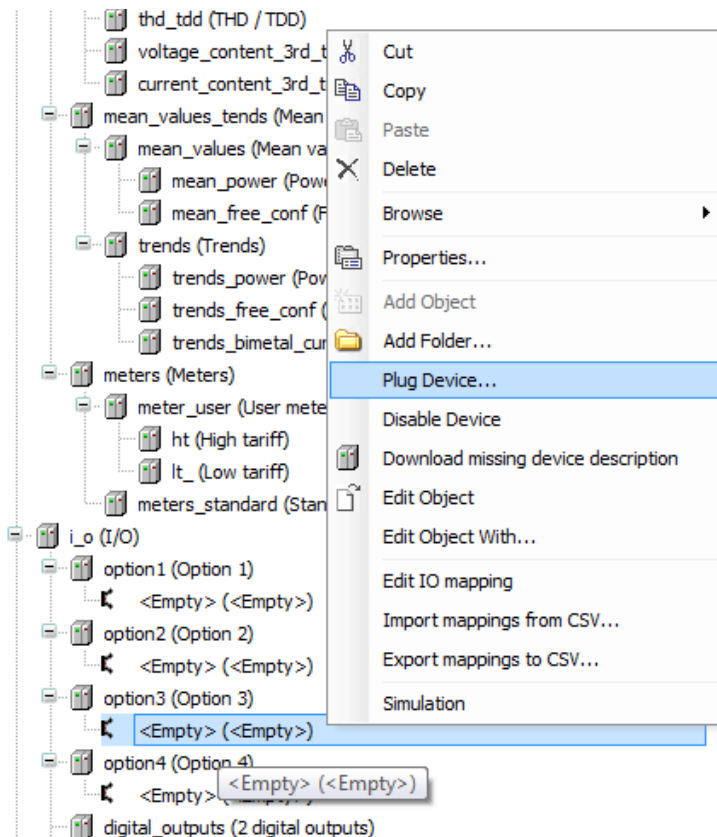

Select the correct module and confirm via „Plug Device“.

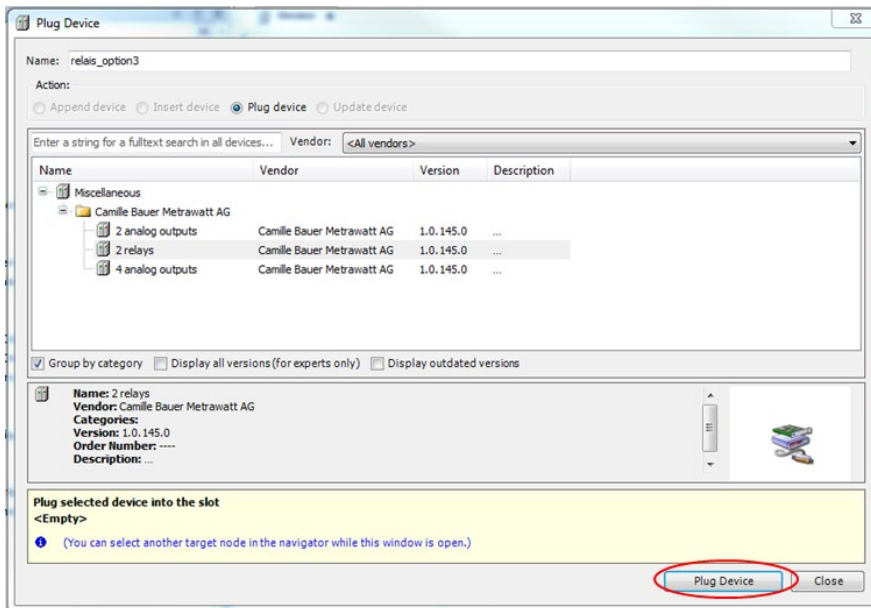

Repeat this procedure until all used options have been plugged in. Leave all unused modules or not control relevant modules such as UPS empty.

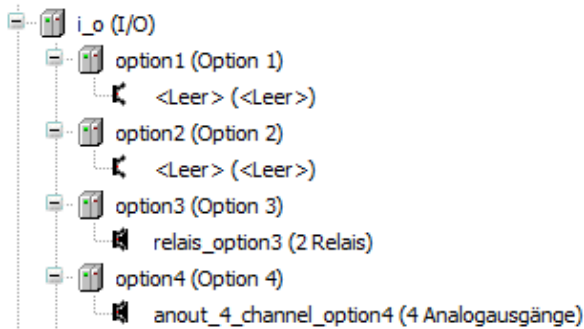

8.6 Using the Modbus master functionality

For the performance classes ADVANCED and PROFESSIONAL Modbus interfaces can also be used to read measurement data from other devices. For the Ethernet interface this master functionality can be used in parallel to the existing Modbus/TCP server functionality.



For the Modbus/RTU interface via RS485 the slave mode is deactivated as soon as the master functionality is used.

Building-up a master/server or master/slave structure is done in four steps:

- Add a field-bus (Ethernet or Modbus RS-485)
- Add the corresponding Master functionality
- Parametrization of the Master
- Add devices to the Master. You may choose from different measurement devices of Camille Bauer and Gossen Metrawatt with a predefined Modbus image respectively direct selectable measurements. For third party products a generic device is available, for which measurements can be added manually.

The principle is shown on the following pages.

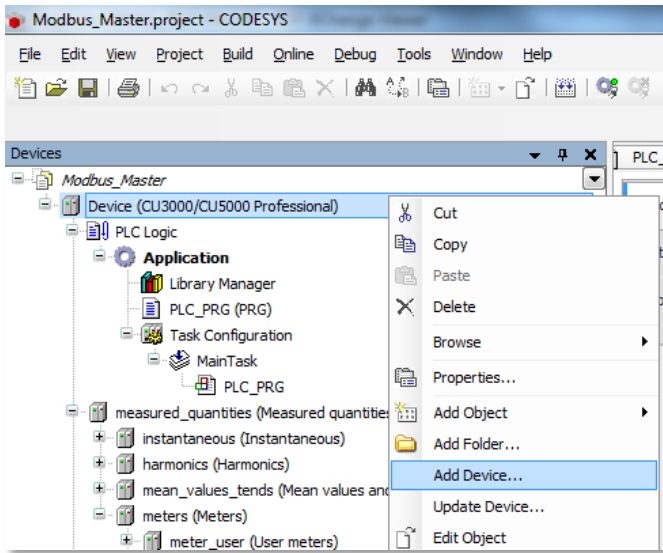

Add device to CUx000

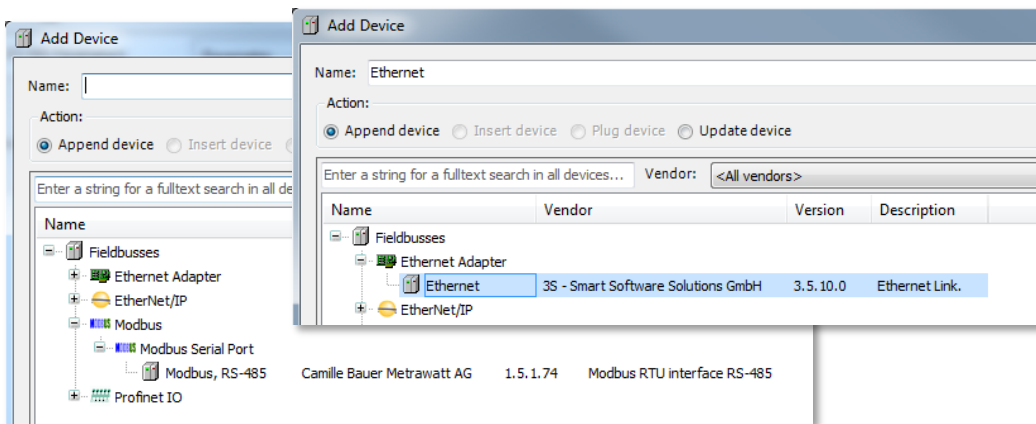

Select interface: Modbus RS-485 or Ethernet

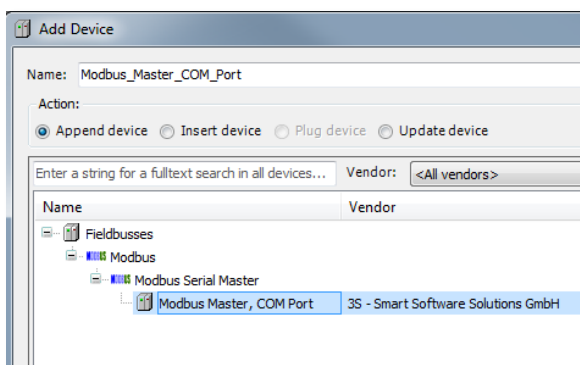
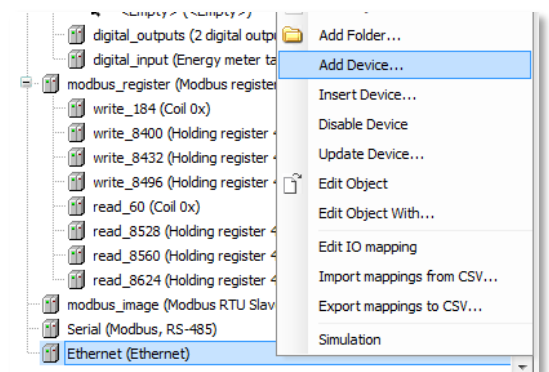
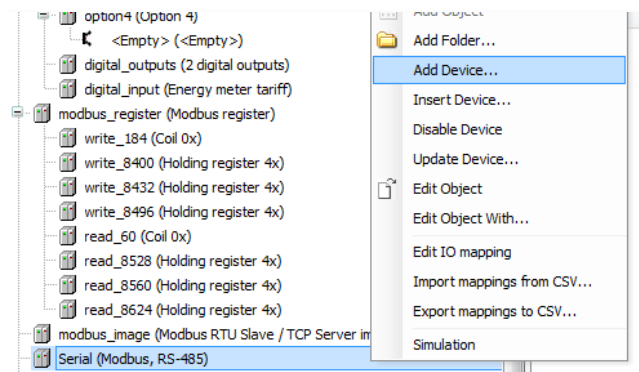

Add Modbus RTU Master to RS-485

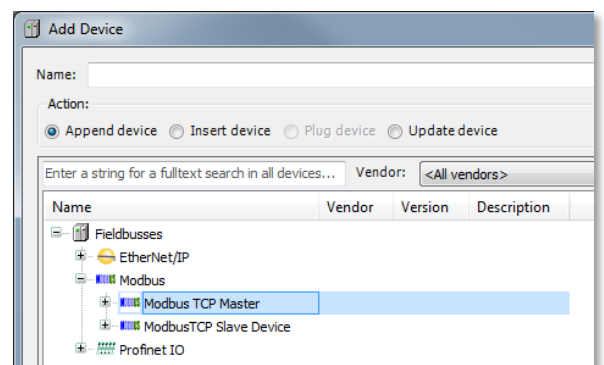

Add Modbus TCP to Ethernet

| Parameter | Type | Value | Default Value | Unit | Description |
|------------|-----------------------|--------|---------------|------|---|
| Baudrate | Enumeration of UDINT | 19200 | 19200 | | Baudrate of the serial port. |
| Parity | Enumeration of STRING | 'NONE' | | | Parity for messages on the serial port. |
| DataBits | USINT | 8 | 8 | | Number of data bits |
| StopBits | USINT | 2 | 2 | | Number of stop bits |
| SerialPort | Enumeration of USINT | RS-485 | RS-485 | | COM port number to use for the serial communication |

Parametrization of the Modbus RTU interface

As the RS-485 Modbus / RTU slave interface is deactivated when the master is activated, the device settings of this communication interface are no longer active. The transmission parameters of the RS-485 must therefore be set here.

The Ethernet interface does not require separate settings. The network parameters of the device settings are applied. To prevent warnings in the CODESYS environment the interface can be set to **eth0**, which corresponds to the Ethernet settings of the device.

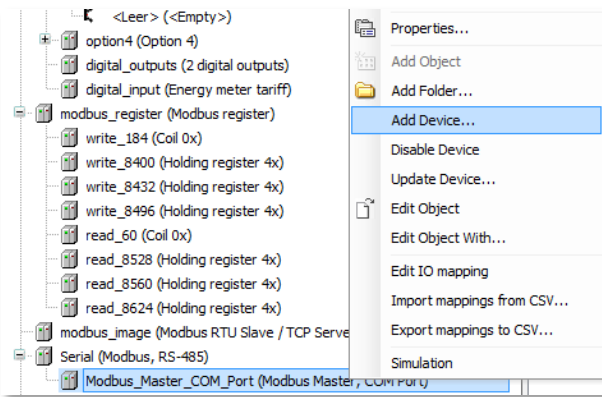
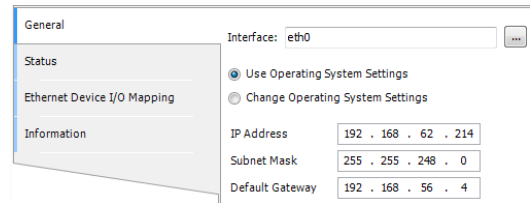

Connect a device to the master (here to Modbus RTU)

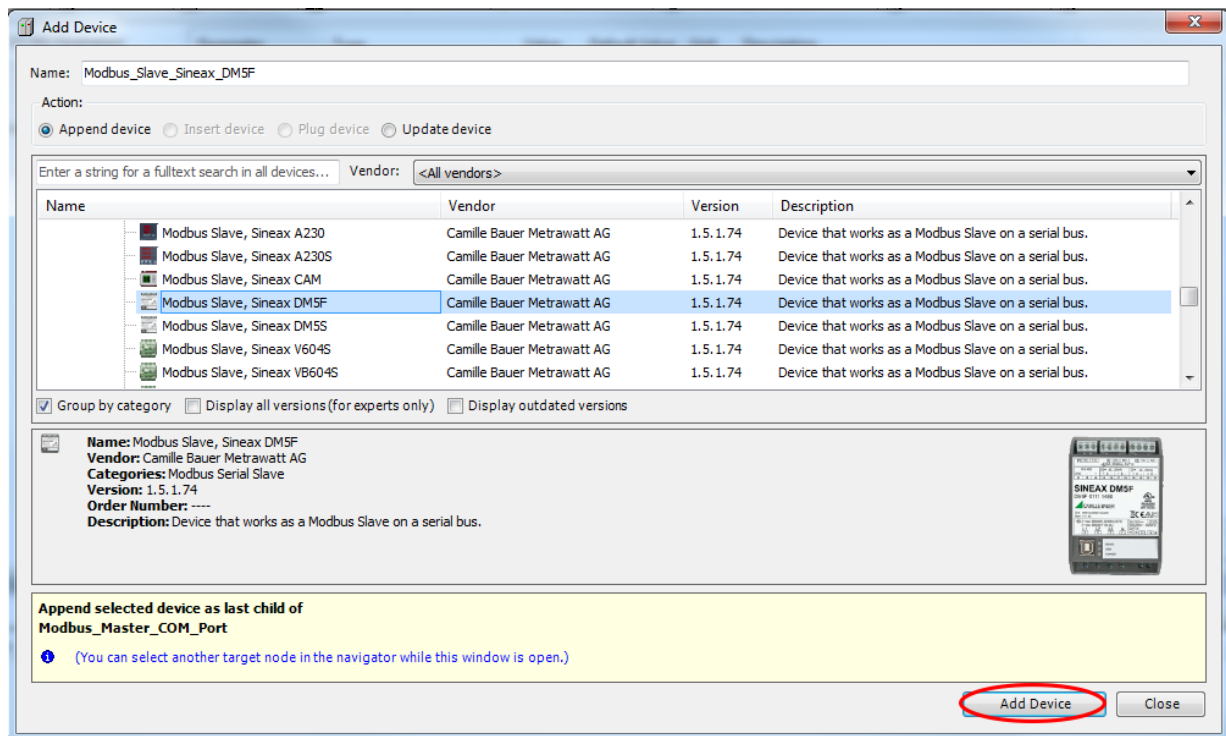

Example: Connecting a SINEAX DM5F

As long as the above window is displayed further devices can be selected and connected to the master using "Add device".

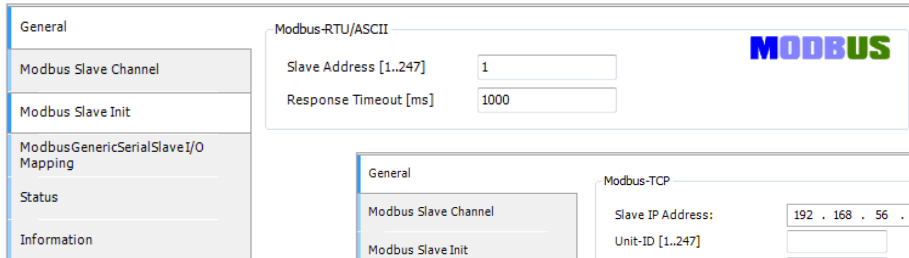

Device address Modbus/RTU

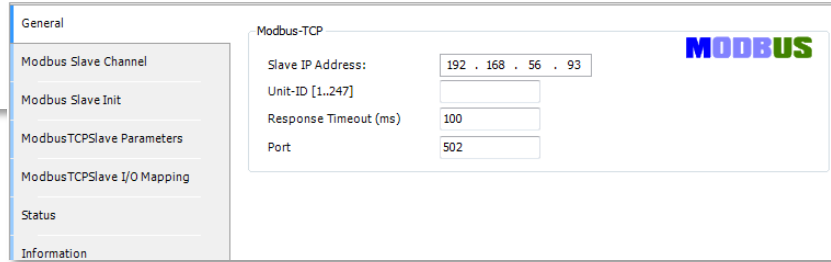

IP address and TCP port for Modbus TCP Slave

| Name | Access Type | Trigger | READ Offset | Length | Error Handling | W |
|-------------|---|-----------------|-------------|--------|-----------------|---|
| 0 DMSF_U1N | Read Holding Registers (Function Code 03) | Cyclic, t#500ms | 16#0065 | 2 | Keep last Value | |
| 1 DMSF_U2N | Read Holding Registers (Function Code 03) | Cyclic, t#500ms | 16#0067 | 2 | Keep last Value | |
| 2 DMSF_U3N | Read Holding Registers (Function Code 03) | Cyclic, t#500ms | 16#0069 | 2 | Keep last Value | |
| 3 Channel 3 | Read Holding Registers (Function Code 03) | Cyclic, t#500ms | 16#0065 | 6 | Keep last Value | |

Add the measurements to be read from the device

The Modbus interface allows reading single words or a multiple of them. The data type is determined by the assignment to a variable or a variable group.

Measurements can be queried individually or several at the same time. Individual readings typically have a length of 2 words, shown above for the queries 0 ... 2 (U1N, U2N, U3N). Each value can be selected directly from the list of available measurements using the opposite mask. The trigger can be used to define whether the value is to be polled cyclically or dependent on the state of a logical variable. The available measured quantities result from the selected access type.

With only one query also several measurements can be read simultaneously, shown above for the query 3, which provides the values U1N, U2N and U3N. In contrast to the queries 0 ... 2, where a direct assignment to one REAL variable is possible, the result of query 3 is assigned to a structure consisting of 3 REAL variables.

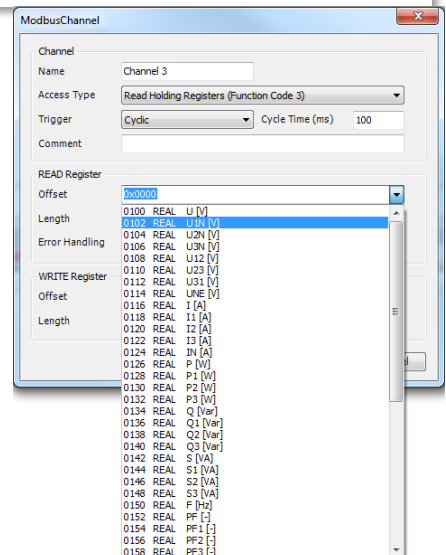

| Variable | Mapping | Channel | Address | Type | Unit | Description |
|--------------------------|---------|--------------|---------|----------------------|------|------------------------|
| Application.PLC_PRG.d... | | DMSF_U1N | %IW1885 | ARRAY [0..1] OF WORD | | Read Holding Registers |
| | | DMSF_U1N[0] | %IW1885 | WORD | | 0102 REAL U1N [V] |
| | | DMSF_U1N[1] | %IW1886 | WORD | | 0102 |
| Application.PLC_PRG.d... | | DMSF_U2N | %IW1887 | ARRAY [0..1] OF WORD | | Read Holding Registers |
| | | DMSF_U2N[0] | %IW1887 | WORD | | 0104 REAL U2N [V] |
| | | DMSF_U2N[1] | %IW1888 | WORD | | 0104 |
| Application.PLC_PRG.d... | | DMSF_U3N | %IW1889 | ARRAY [0..1] OF WORD | | Read Holding Registers |
| | | DMSF_U3N[0] | %IW1889 | WORD | | 0106 REAL U3N [V] |
| | | DMSF_U3N[1] | %IW1890 | WORD | | 0106 |
| Application.PLC_PRG.d... | | Channel 3 | %IW1891 | ARRAY [0..5] OF WORD | | Read Holding Registers |
| | | Channel 3[0] | %IW1891 | WORD | | 0102 REAL U1N [V] |
| | | Channel 3[1] | %IW1892 | WORD | | 0102 |
| | | Channel 3[2] | %IW1893 | WORD | | 0104 REAL U2N [V] |
| | | Channel 3[3] | %IW1894 | WORD | | 0104 |
| | | Channel 3[4] | %IW1895 | WORD | | 0106 REAL U3N [V] |
| | | Channel 3[5] | %IW1896 | WORD | | 0106 |

Assignment of the acquired measurement to variables

8.7 Creating the CODESYS application

At this stage in the project the control application needs to be created. For that a POU (Programmable Organisation Unit) with name **PLC_PRG** was generated during project creation. Double click on this item to open the editor view.

In the declaration part **1** variables and other POU's may be declared, which will be needed in this PLC_PRG. In the bottom part **2** the program code will be written. On the right side **3** a ToolBox is located, from where objects may be included into the program via Drag & Drop. The tool box depends on the programming language selected.

The further process for creating an application is not part of these brief instructions.



8.7.1 Using remanent variables

The device stores remanent variables in such a way that their contents remains unchanged even if the device is restarted or after a power-down.

The declaration of remanent variables is done by means of VAR RETAIN. The memory area for RETAIN variables is limited to 1000 bytes.

The content of remanent variables is reset under two conditions:

- Reset cold: All VAR and VAR RETAIN variables are reset
- Reset origin: When the PLC is reset to its original state, the application is deleted and thus all associated variables

The various reset options are described in a [separate chapter](#).

8.7.2 Using the data logger

Exclusively for devices with performance class PROFESSIONAL a facility is provided to record data or messages via CODESYS over a longer period of time.

To be able to use recording functions, the CENTRAX library must be added, which is part of the device description. This is done using the library manager.

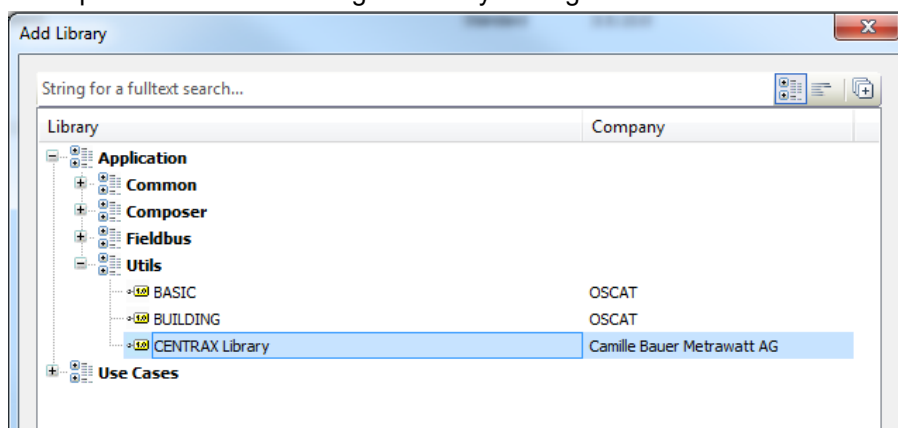

Recording capability

Associated function

| | |
|---|---|
| 20 channels REAL (32-bit floating point) | stat := LogAdd_REAL(channel, value, timestamp) |
| 20 channels LREAL (64-bit floating point) | stat := LogAdd_LREAL(channel, value, timestamp) |
| 20 channels BOOL, e.g. for events | stat := LogAdd_BOOL(channel, value, timestamp) |

with: *stat*: return value, TRUE if executed successfully

channel: recording channel 1...20

value: value to store

timestamp: [ms] since 1.1.1970 00:00:00; set it to 0 to use the present system time

Amount of time per time unit

With more than approx. 17 function calls per second, functional failures (return value FALSE) can occur.

Channel description / unit

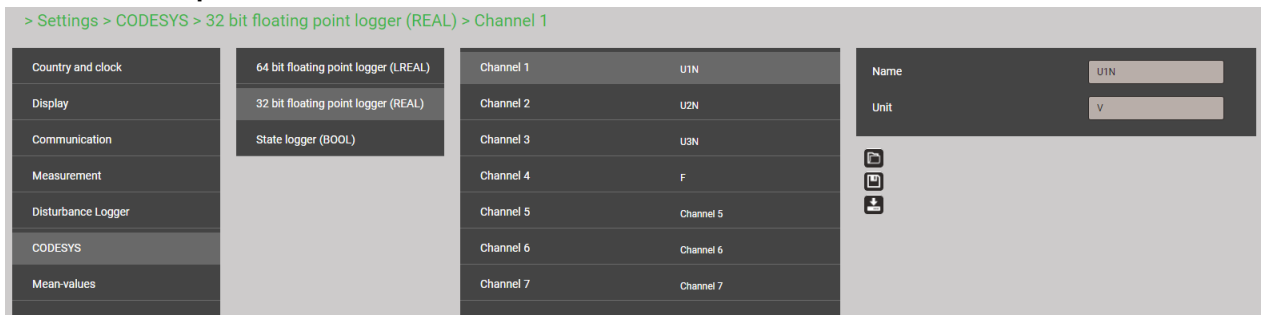

REAL / LREAL: Per recording channel a description and a unit can be defined

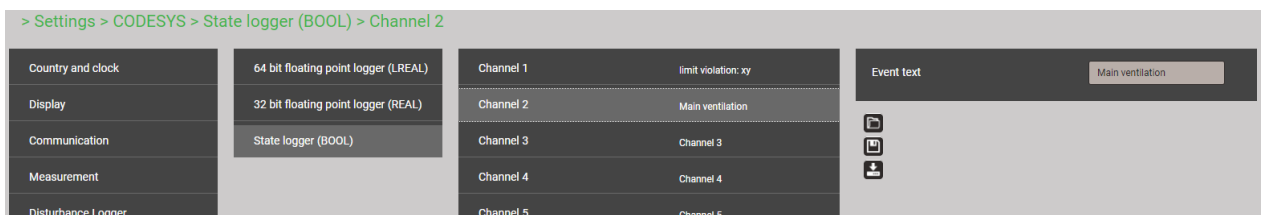

BOOL: Per recording channel an event text can be associated

Displaying CODESYS recordings

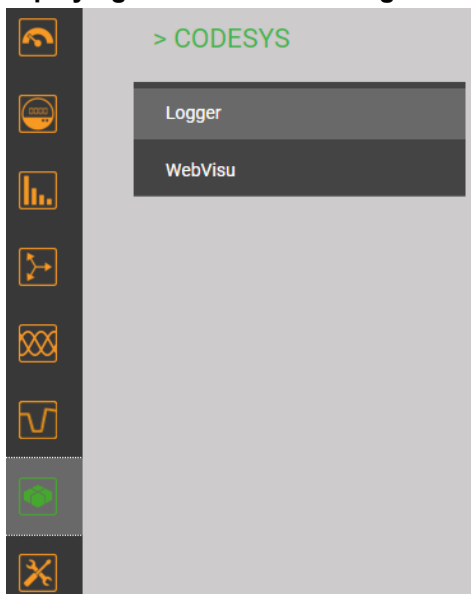

- Data is either available as a value table or event list
- Data can be exported [exported in CSV format](#)

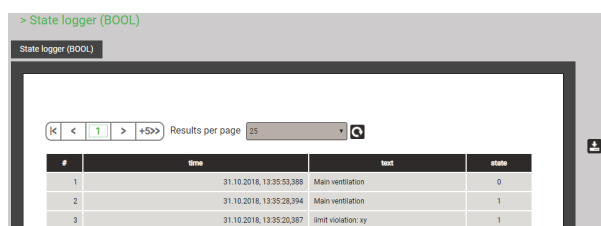
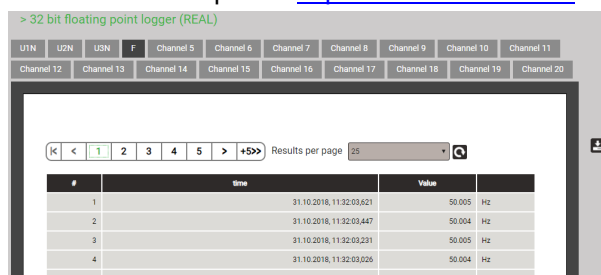

8.8 Creating own visualizations

Exclusively for devices with performance class PROFESSIONAL, it is possible to create own visualizations by means of CODESYS, both for the local display as well as for WEB access.

8.8.1 Adding a visualization to the project

In the CODESYS project right-click on *Application*, *Add object* and then select *Visualization*. In the Window *Add visualization* assign a name to the visualization.

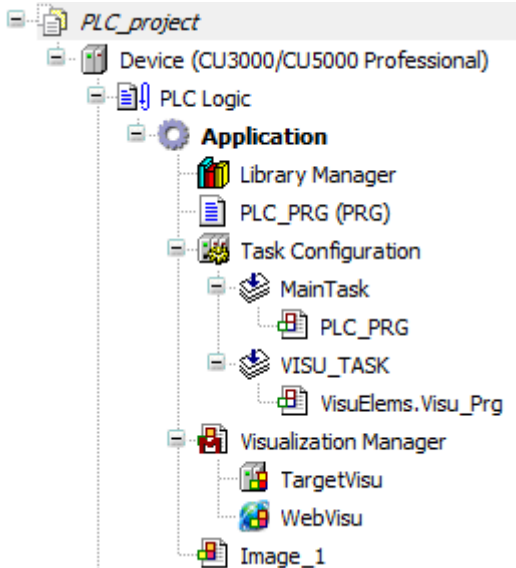

Via **[VISU_TASK]** the features of the visualization application can be defined

Using the **[Visualization Manager]** the features of the target or WEB visualization can be modified

[Image_1] is the area for creating the visualization

8.8.2 Target visualization (TargetVisu)

If the device is equipped with a local display, user-defined images can be used to display process data.

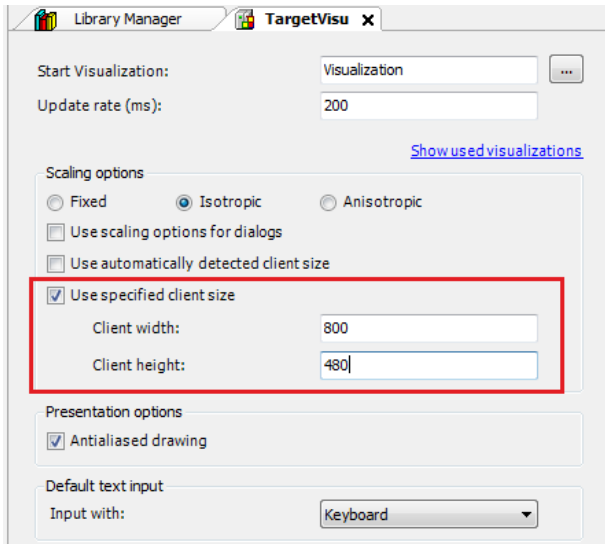

Usable resolution

- CU3000: 800 x 480 px
- CU5000: 320 x 240 px

The device keys (ESC, Up, Down, Left, Right) can be freely used for switching the displayed image, for selections or control purposes.

Via device settings you can define if the standard images or the user-defined images of the device have to be displayed. A direct switching during operation is not possible.

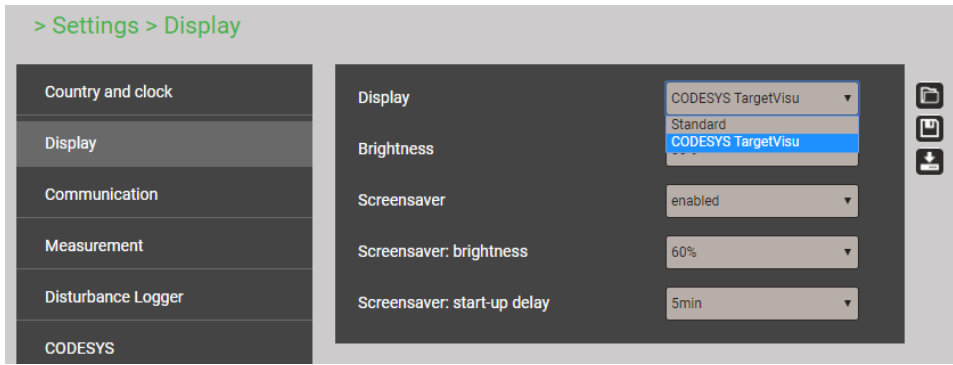

8.8.3 WEB visualizations (WebVisu)

The user can define multiple web pages with any mechanism for changing the displayed image. The visualization begins with a definable start visualization. The starting page can be viewed in two ways:

- a) http://<IP_ADDR>:8080/<NAME>.htm

<IP_ADDR>: IP address of the device, e.g. 192.168.1.101

<NAME>: Name of the .htm file used as start page, z.B. webvisu (see below)

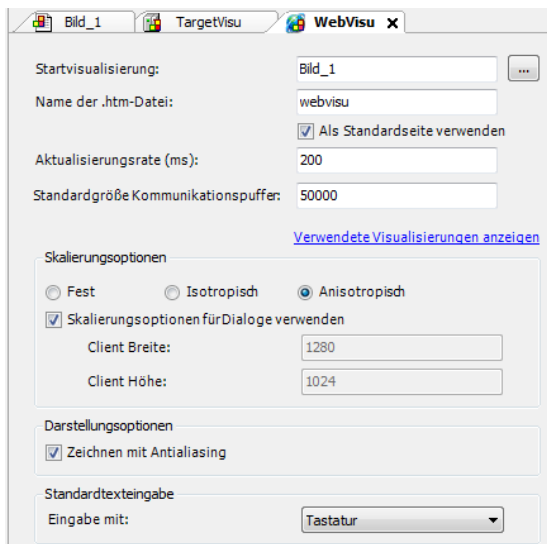

- b) Direct call via device website

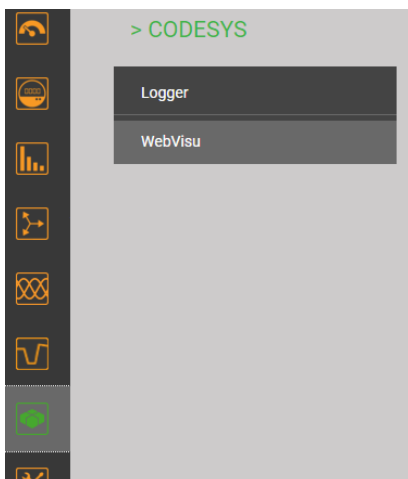

Hint

This call works only if the name of the start visualization is left at the default **webvisu.htm**.

8.9 Establishing a connection to the device

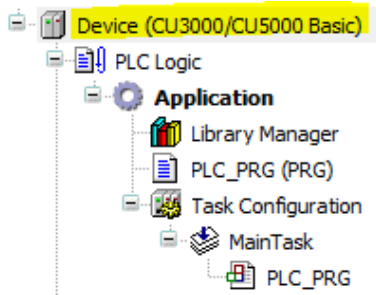

Double click on **Device (CU3000/CU5000 Basic)** in the device tree. The below shown view will be opened.

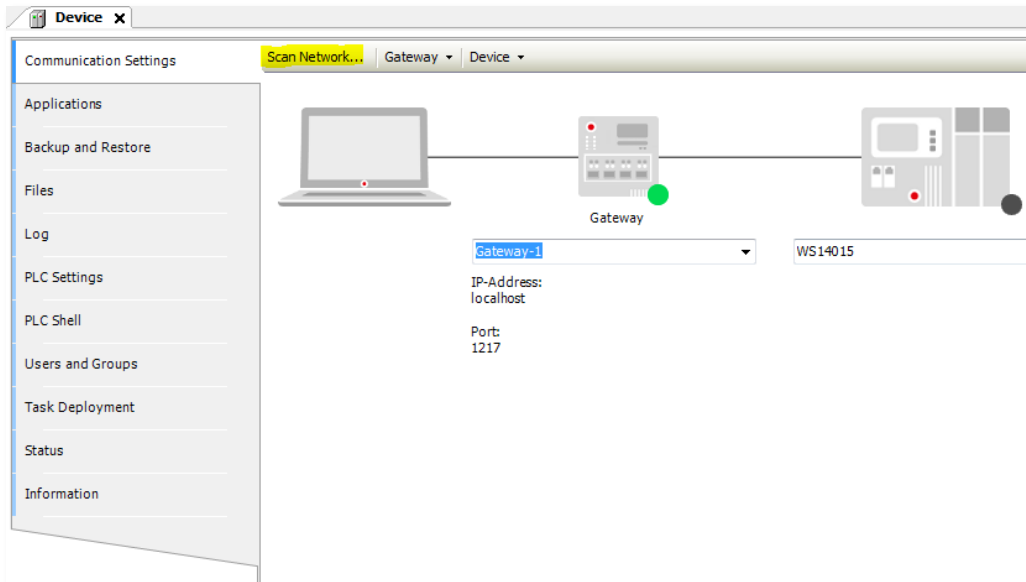

In the communication settings click on **Scan Network**. A list will be shown with all the devices visible from your PC.

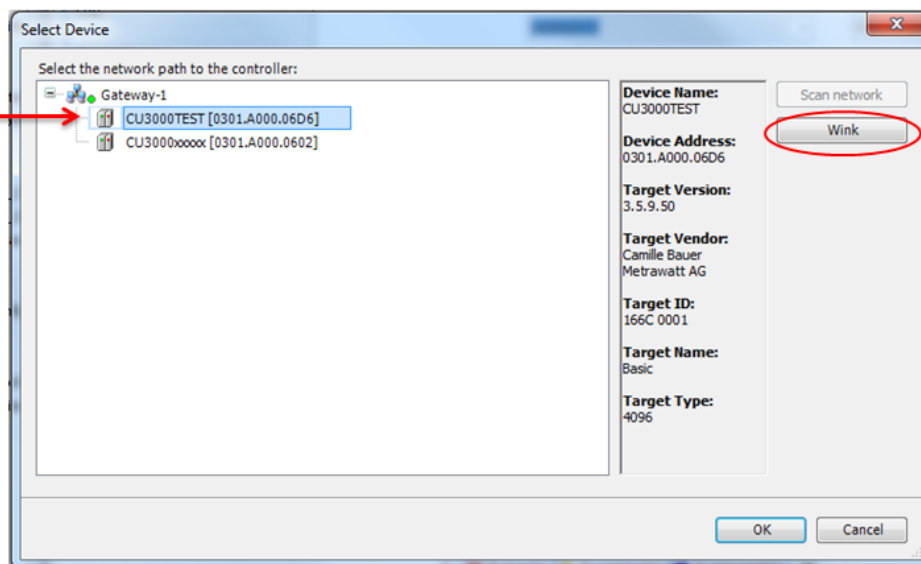

The device is best identified by its hostname, defined in the Ethernet communication settings. In the above example the hostname **CU3000TEST** was assigned, the other device still has the initial setting CU3000xxxxx.

To be sure that you are communicating with the right device, select the device and click on **Wink**: The display of the associated device will start blinking for a few seconds.

Use **OK** to confirm your device selection. If OK is greyed out, even if "Wink" works fine, there may be a mismatch in the performance class used in the project (e.g. BASIC) and the type of the device (e.g. ADVANCED).

Identification is possible as well via the device address, in the above example 0301.A000.06D6. This address may be verified via the device webpage.

In the service menu go to **CODESYS | Device information**:

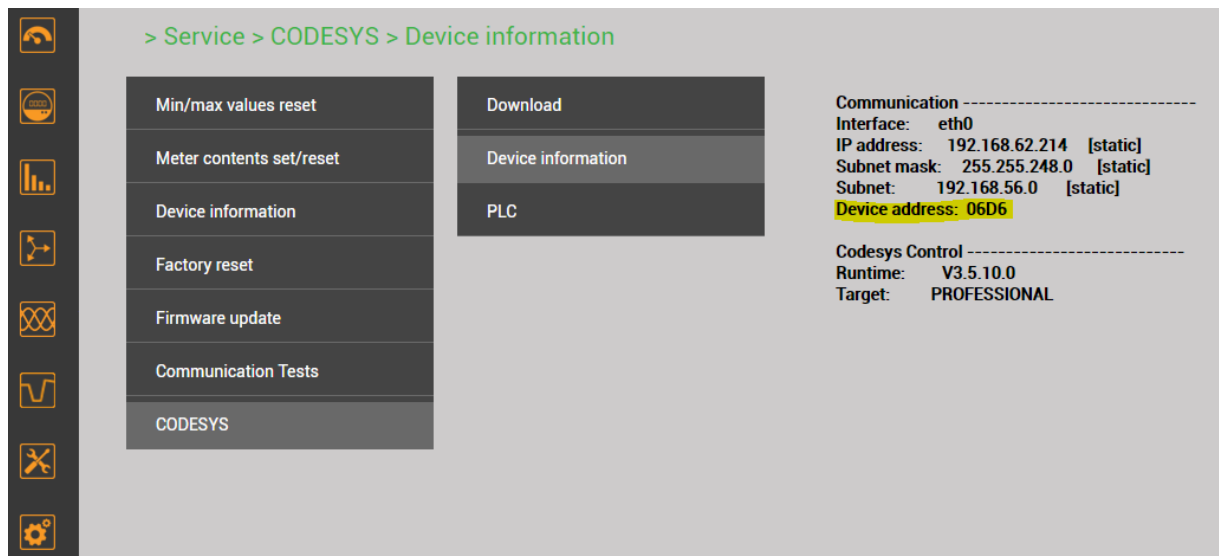

8.10 Loading the application to the device

- Load the application to the device by going online with a click 
- If the device description in the device does not correspond to the version used in the CODESYS-IDE for example the following warning message is displayed:

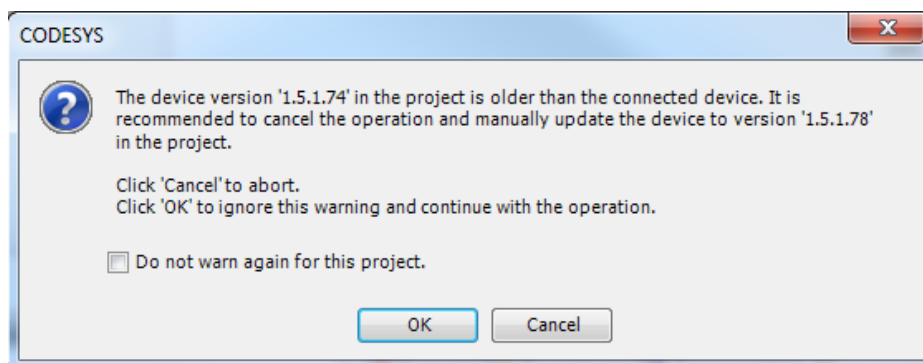

In this case the device description of the project can be updated. For that it needs to be installed in the CODESYS-IDE (see [chapter 8.2](#)). Then the project can be updated:

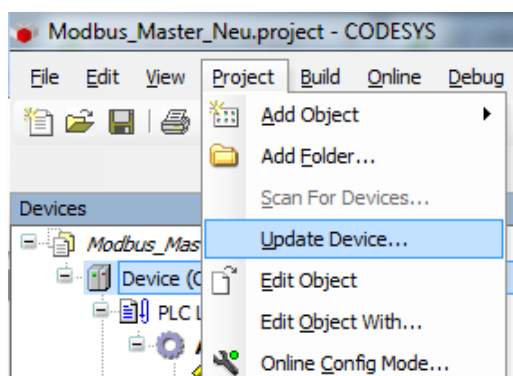

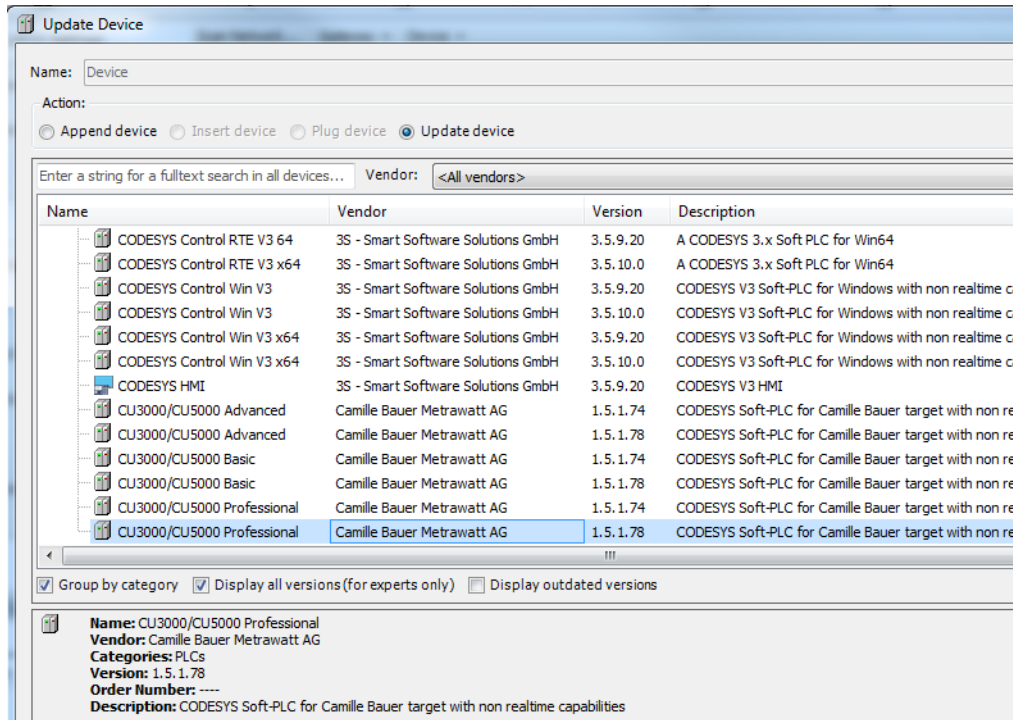

If the initial situation is reversed, i.e. the version of the device description used in the project is higher than the one of the device, either the firmware of the device must be updated or an older version of the device description must be used in the project. New firmware versions can be downloaded free of charge from our website

<https://www.camillebauer.com/cu3000-en> or <https://www.camillebauer.com/cu5000-en>.

- If there is no application on the device, you will be asked to proceed with the download. Confirm with **Yes**.



- The program will be loaded to the device.



The present state of the application can also be seen via webpage: Service | CODESYS | PLC

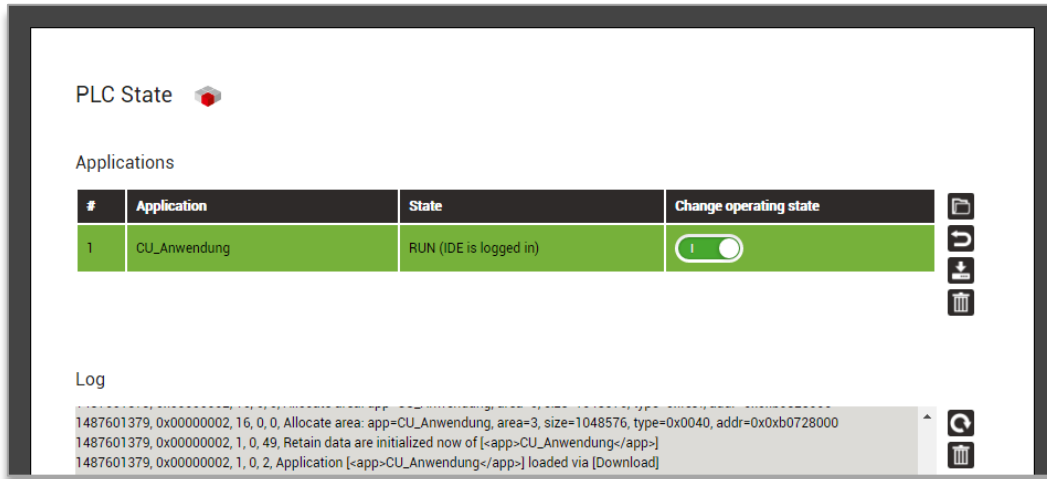

Using the switch in the column „Change operating state“ the application may be stopped and started again at any time.

For devices with display the state of the application may be checked and changed also locally at the device: Service | CODESYS | PLC

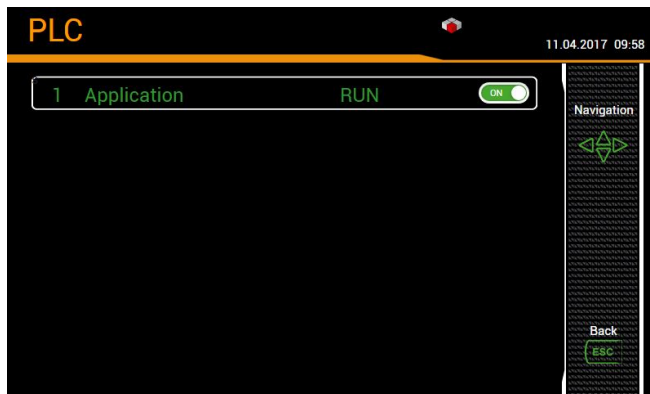

8.11 Loading the application on-site

8.11.1 Creating a boot application

For on-site loading of the control application into the device, first you have to create a boot application in the CODESYS development environment.

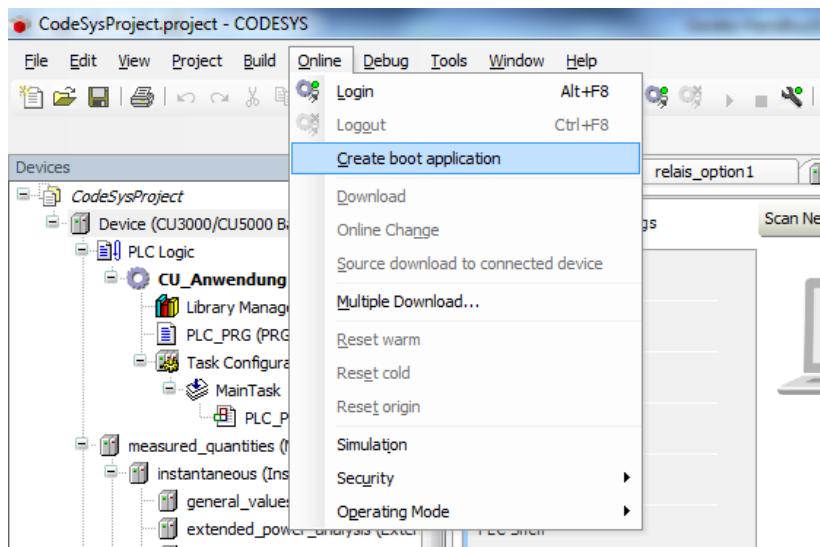

Two files will be created: <appl_name>.app und <appl_name>.crc. The user has to pack them in a ZIP file.

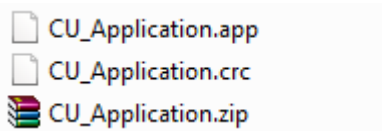

8.11.2 Deleting the active application

An application already running must to be deleted.

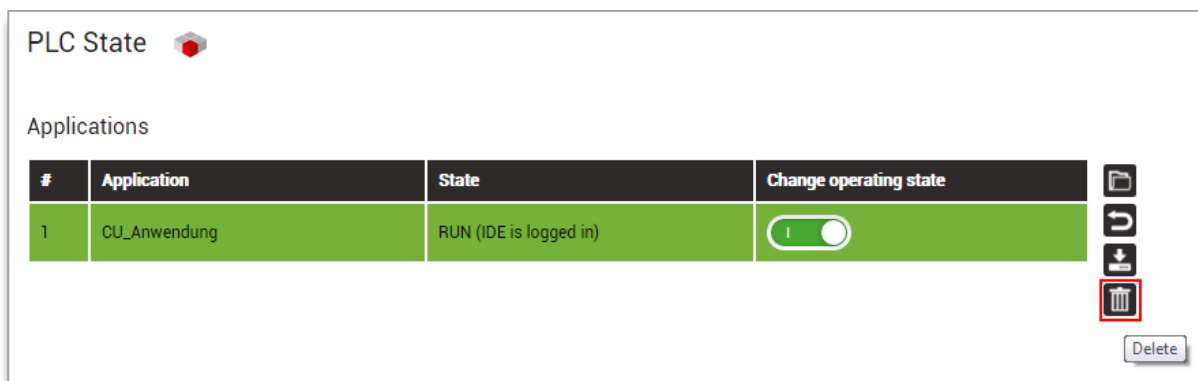

8.11.3 Loading the application

When loading the application the previously created ZIP file must be uploaded.

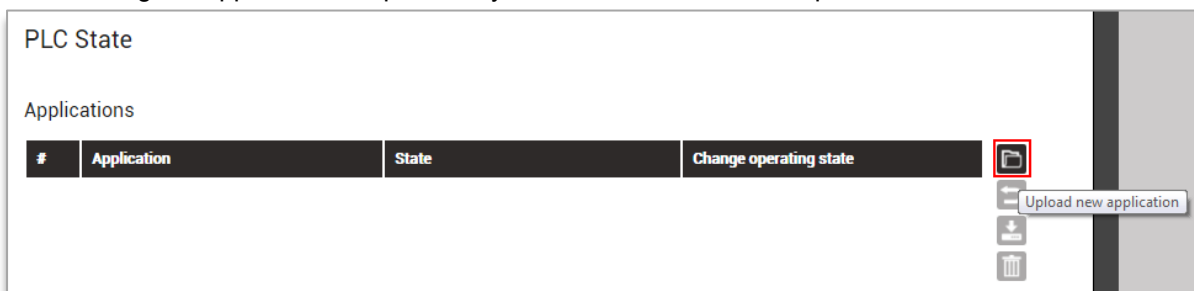

8.11.4 Starting the application

The uploaded application is not automatically started. Use the switch in the column „Change operating state“ to start the application.

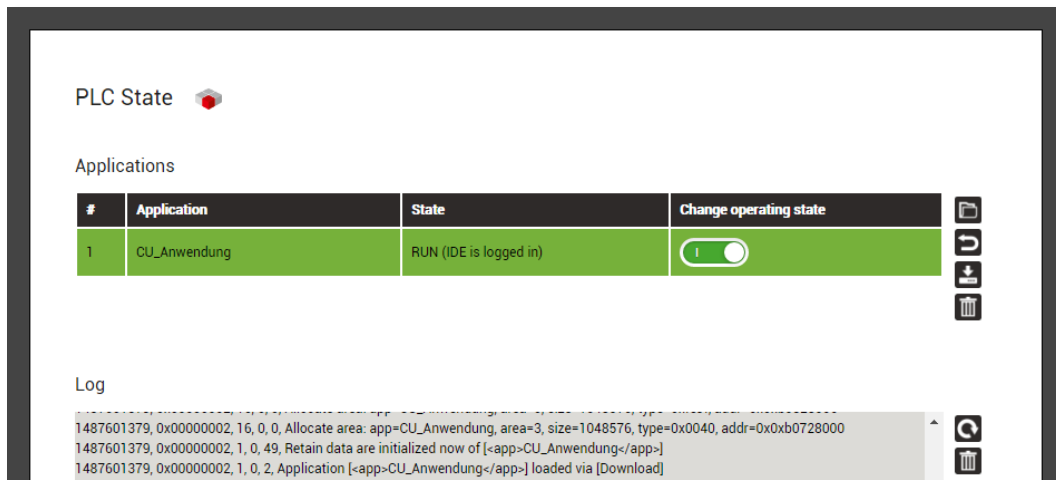

Only applications which have been uploaded to the device via ZIP file can be downloaded to a PC again. The originally uploaded ZIP file will be exported.

8.11.5 Resetting the active application

The active application may be reset ([Reset warm](#)).

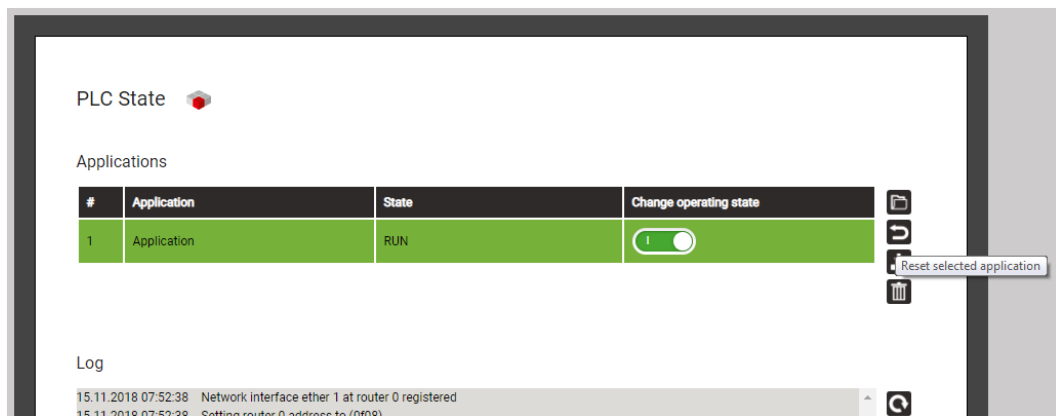

8.12 Reset

The PLC supports the reset operations described below.

| Version | Execution | System behavior |
|--------------|--|---|
| Reset warm | <ul style="list-style-type: none"> • Reset via webpage • <i>Reset warm</i> via CODESYS | <ul style="list-style-type: none"> • Application is stopped • Standard variables (VAR) are initialized • Remanent variables (VAR RETAIN) keep their values |
| Reset cold | <ul style="list-style-type: none"> • Download application to the device via IDE • Loading the application via webpage • <i>Reset cold</i> via CODESYS | <ul style="list-style-type: none"> • Application is stopped • All variables (VAR, VAR RETAIN) are initialized |
| Reset origin | <ul style="list-style-type: none"> • Deleting the application via webpage • <i>Reset origin</i> via CODESYS | <p>Reset PLC to ist origin</p> <ul style="list-style-type: none"> • Application is stopped and deleted from the device • All variables (VAR, VAR RETAIN) are initialized |

Reset via CODESYS-IDE

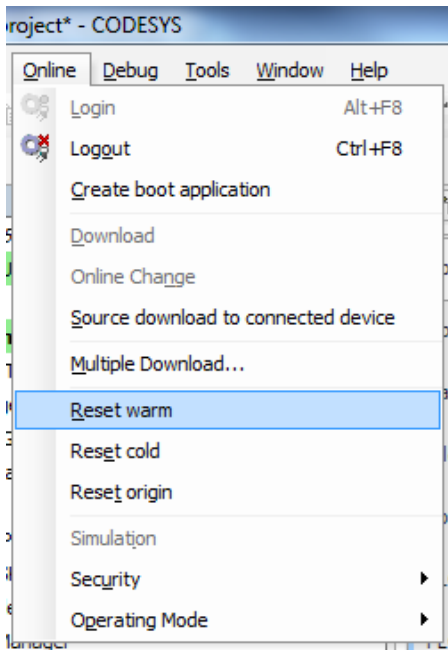

8.13 Project management

Source download to the device

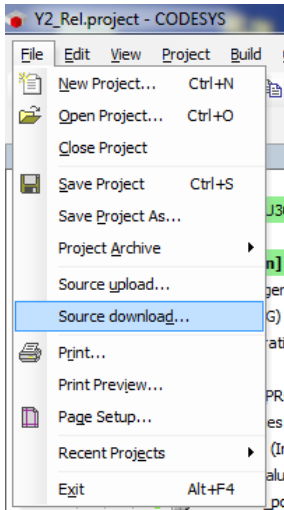

Source download to the device

The project created via CODESYS-IDE can be saved in the device. This simplifies the modification of the application on-site.

Hint: Initially the source code is not protected, but CODESYS supports a user management system and data encryption via certificates.

Source upload from the device

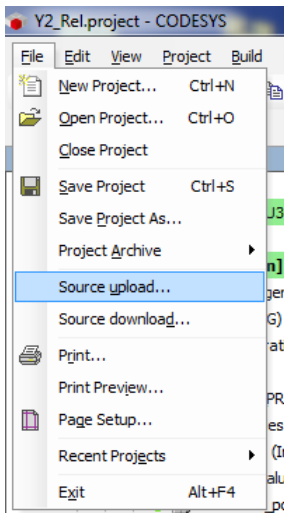

If the source code has been saved in the device, it may be uploaded again using the CODESYS development environment. This simplifies the modification of the application on-site.

Hint: Initially the source code is not protected, but CODESYS supports a user management system and data encryption via certificates.

8.14 Services

Unless otherwise agreed, the creation of the control application is the responsibility of the user. Thus, the user is solely responsible for the application he has created. Camille Bauer Metrawatt AG cannot guarantee that these applications will work properly and will not provide free support for error analysis.

In addition to the product CENTRAX CUx000 itself, Camille Bauer Metrawatt AG (and selected distributors) offers the following services:

- Creating the control application according to a customer specification
- Support Package when the control application is created by the customer

For more details on the services offered, please contact your local sales organization.

8.13 Example projects

For an easy beginning you may find example projects for a few control applications on our website:

<https://www.camillebauer.com/cu3000-en> or <https://www.camillebauer.com/cu5000-en>.

9. Service, maintenance and disposal

9.1 Calibration and new adjustment

Each device is adjusted and checked before delivery. The condition as supplied to the customer is measured and stored in electronic form.

The uncertainty of measurement devices may be altered during normal operation if, for example, the specified ambient conditions are not met. If desired, in our factory a calibration can be performed, including a new adjustment if necessary, to assure the accuracy of the device.

9.2 Cleaning

The display and the operating keys should be cleaned in regular intervals. Use a dry or slightly moist cloth for this.



Damage due to detergents

Detergents may not only affect the clearness of the display but also can damage the device. Therefore, do not use detergents.

9.3 Battery

The device contains a battery for buffering the internal clock. It cannot be changed by the user. The replacement can be done at the factory only.

If the UPS option is implemented, the associated battery pack needs to be exchanged regularly. For more information see [chapter 5.13](#).

9.4 Disposal

The product must be disposed in compliance with local regulations. This particularly applies to the built-in battery for the RTC and the battery pack of the UPS option.

10. Technical data

Inputs

| | |
|-------------------------|--|
| Nominal current: | adjustable 1...5 A; max. 7.5 A (sinusoidal) |
| Measurement category: | 300V CAT III |
| Consumption: | $\leq I^2 \times 0.01 \Omega$ per phase |
| Overload capacity: | 10 A continuous 100 A, 5 x 1 s, interval 300 s |
| Nominal voltage: | 57.7...400 V _{LN} (UL: 347V _{LN}), 100...693 V _{LL} (UL: 600V _{LL}); |
| Measurement max.: | CU3000: 480 V _{LN} , 832 V _{LL} (sinusoidal); CU5000: 520 V _{LN} , 900 V _{LL} (sinusoidal) |
| Measurement category: | 600V CAT III |
| Consumption: | $\leq U^2 / 1.54 M\Omega$ per phase |
| Impedance: | 1.54 M Ω per phase |
| Overload capacity: | continuous: 480 V _{LN} , 832 V _{LL} (CU3000); 520 V _{LN} , 900 V _{LL} (CU5000) 10 x 1 s, Intervall 10s: 800 V _{LN} , 1386 V _{LL} |
| Systems: | Single phase Split phase (2-phase system) 3-wire, balanced load 3-wire, balanced load, phase shift (2xU, 1xI) 3-wire, unbalanced load 3-wire, unbalanced load, Aron connection 4-wire, balanced load 4-wire, unbalanced load 4-wire, unbalanced load, Open-Y |
| Nominal frequency: | 42... <u>50</u> ...58Hz or 50.5... <u>60</u> ...69.5Hz, configurable |
| Sampling rate: | 18 kHz |

Measurement uncertainty

Reference conditions: Acc. IEC/EN 60688, ambient 15...30°C, sinusoidal input signals (form factor 1.1107), no fixed frequency for sampling, measurement time 200ms (10 cycles at 50Hz, 12 cycles at 60Hz)

| | |
|-------------------|---|
| Voltage, current: | $\pm 0.1\%$ ^{1) 2)} |
| Neutral current: | $\pm 0.2\%$ ¹⁾ (if calculated) |
| Power: | $\pm 0.2\%$ ^{1) 2)} |
| Power factor: | $\pm 0.2^\circ$ |
| Frequency: | ± 0.01 Hz |
| Imbalance U, I: | $\pm 0.5\%$ |
| Harmonics: | $\pm 0.5\%$ |
| THD U, I: | $\pm 0.5\%$ |
| Active energy: | Class 0.2S, EN 62053-22 |
| Reactive energy: | Class 0.5S, EN 62053-24 |

Measurement with fixed system frequency:

| | |
|-------------|---|
| General | \pm Basic uncertainty x (F _{config} -F _{actual}) [Hz] x 10 |
| Imbalance U | $\pm 2\%$ up to ± 0.5 Hz |
| Harmonics | $\pm 2\%$ up to ± 0.5 Hz |
| THD, TDD | $\pm 3.0\%$ up to ± 0.5 Hz |

¹⁾ Related to the nominal value of the basic quantity

²⁾ Additional uncertainty if neutral wire not connected (3-wire connections)

- Voltage, power: 0.1% of measured value; load factor: 0.1°
- Energy: Voltage influence x 2, angle influence x 2

Zero suppression, range limitations

The measurement of specific quantities is related to a pre-condition which must be fulfilled, that the corresponding value can be determined and sent via interface or displayed. If this condition is not fulfilled, a default value is used for the measurement.

| Quantity | Condition | Default |
|--------------------|--|-------------------|
| Voltage | $U_x < 1\% U_{Xnom}$ | 0.00 |
| Current | $I_x < 0,1\% I_{Xnom}$ | 0.00 |
| PF | $S_x < 1\% S_{Xnom}$ | 1.00 |
| QF, LF, $\tan\phi$ | $S_x < 1\% S_{Xnom}$ | 0.00 |
| Frequency | voltage and/or current input too low ¹⁾ | Nominal frequency |
| Voltage unbalance | $U_x < 5\% U_{Xnom}$ | 0.00 |
| Current unbalance | mean value of phase currents $< 5\% I_{Xnom}$ | 0.00 |
| Phase angle U | at least one voltage $U_x < 5\% U_{Xnom}$ | 120° |
| Harmonics U, THD-U | fundamental $< 5\% U_{Xnom}$ | 0.00 |

¹⁾ Specific levels depend on the device configuration

Power supply via terminals 13-14

| CU3000 (see nameplate) | OVC ¹⁾ | Consumption ²⁾ |
|--|-------------------|---------------------------|
| V1: 110...230V AC 50/60Hz / 130...230V DC $\pm 15\%$ | III (UL: II) | ≤ 30 VA, ≤ 13 W |
| V2: 24...48V DC $\pm 15\%$ | - | ≤ 13 W |
| V3: 110...200V AC 50/60Hz / 110...200V DC $\pm 15\%$ | III (UL: II) | ≤ 30 VA, ≤ 13 W |
| CU5000 (see nameplate) | OVC ¹⁾ | Consumption ²⁾ |
| V1: 100...230V AC 50/60Hz / DC $\pm 15\%$ | III | ≤ 27 VA, ≤ 12 W |
| V2: 24...48V DC $\pm 15\%$ | - | ≤ 12 W |

¹⁾ Overvoltage category (OVC); ²⁾ depends on the device hardware used

Available inputs / outputs and functional extensions

| | |
|-------------------|---|
| Basic unit | <ul style="list-style-type: none"> • 1 digital input • 2 digital outputs |
| Extensions | Optional modules <ul style="list-style-type: none"> • 2 relay outputs with changeover contacts • 2 bipolar analog outputs • 4 bipolar analog outputs • 4 passive digital inputs • 4 active digital inputs • GPS connection module • 2 failure current channels (residual or earth current) • IEC61850 interface • 2 temperature inputs |

- CU3000: Up to 4 I/O extensions may be present in the device. Only one module can be equipped with analog outputs.
- CU5000: Up to 2 I/O extensions may be present in the device.

I/O interface

Relays

via plug-in terminals
 Contact: changeover contact
 Load capacity: 250 V AC, 2 A, 500 VA
 30 V DC, 2 A, 60 W

| | |
|---|---|
| <u>Analog outputs</u> | via plug-in terminals |
| Linearization: | Linear, kinked |
| Range: | ± 20 mA (24 mA max.), bipolar |
| Uncertainty: | $\pm 0.2\%$ of 20 mA |
| Burden: | $\leq 500 \Omega$ (max. 10 V / 20 mA) |
| Burden influence: | $\leq 0.2\%$ |
| Residual ripple: | $\leq 0.4\%$ |
| Response time: | 220...420 ms |
| <u>Passive digital inputs</u> | via plug-in terminals |
| Nominal voltage | 12 / 24 V DC (30 V max.) |
| Input current | < 7 mA |
| Logical ZERO | - 3 up to + 5 V |
| Logical ONE | 8 up to 30 V |
| Minimum pulse width | 70...250ms |
| <u>Active digital inputs</u> | via plug-in terminals |
| Open circuit voltage | ≤ 15 V |
| Short circuit current | < 15 mA |
| Current at $R_{ON}=800\Omega$ | ≥ 2 mA |
| Minimum pulse width | 70...250ms |
| <u>Digital outputs</u> | via plug-in terminals |
| Nominal voltage | 12 / 24 V DC (30 V max.) |
| Nominal current | 50 mA (60 mA max.) |
| <u>Fault current detection</u> | via plug-in terminals |
| Number of channels | 2; each channel provides two measurement ranges (2mA, 1A) |
| Zero suppression | Measurement $< 0.2\%$ of measurement range |
| Measurement range 1A | |
| Application: | Direct measurement of a fault or earth wire current |
| Measurement transformer: | Current transformer 1/1 up to 1000/1A Instrument security factor FS5 Rated output 0.2 up to 1.5 VA |
| Measurement range: | $I_{Rated} = 1.0$ A (max. 1.2A; crest factor 3) |
| Overload: | 2A continuous; 20A, 5 x 1s, interval 300s |
| Self-consumption: | $\leq I_2 \times 0.1 \Omega$ |
| Monitoring: | Alarm limit 0.03 ... 1000 A (2 up to 100% of primary measurement range) |
| Measurement range 2mA | |
| Application: | Residual current monitoring (RCM) |
| Measurement transformer: | Residual current transformer 500/1 up to 1000/1A Rated burden 100 Ω / 0.025 VA up to 200 Ω / 0.06 VA |
| Measurement range: | $I_{Rated} = 2$ mA (max. 2.4mA; crest factor 3) |
| Overload: | 40mA continuous; 200mA, 5 x 1s, interval 300s |
| Self-consumption: | $\leq I_2 \times 64 \Omega$ |
| Monitoring: | Alarm limit 0.03 ... 1 A |
| Further settings | |
| Alarm limit for OFF AUS: | $I_{OFF} = 90...75\%$ *) |
| Pre-warning limit: | $I_{WARN} = 50%...(I_{OFF}-1%)$ *) |
| Pre-warning OFF: | $I_{WARN} - (10...25%)$ *) |
| Response delay: | 1...10s, separately for alarm and pre-warning |
| Dropout delay: | 1...300s, separately for alarm and pre-warning |
| *) All percent values are related to the alarm limit (100%) | |

Temperature inputs via plug-in terminals
Number of channels: 2
Measurement current: <1.0mA
Connection: 2-wire
Input protection: Voltage limitation via protective diode

Used for Pt100 measurement

Measurement range: -50 up to 250°C / -58 up to 482°F
Uncertainty: ±1.0 % of measurement ±1 K
Connection monitoring: Short-circuit (<20 Ω), wire / sensor breakage (>1000 Ω)
Alarm limits: 2
Response delay: 0...999 s, separately for each alarm limit
Dropout delay: 0...999 s, separately for each alarm limit

Used for PTC monitoring

Alarm active: >3.6 ... 4.0 kΩ
Alarm fall-back: <1.5 ... 1.65 kΩ
Number of sensors: 1...6 single sensors (acc. DIN 44081) in series
1...2 triplet sensors (acc. DIN 44082) in series
Connection monitoring: Short-circuit (<15 Ω ON, >18 Ω OFF)
Application restriction: Ambient temperature of sensor ≥-20°C
Response delay: 0...999 s
Dropout delay: 0...999 s

Interfaces

Ethernet via RJ45 socket
Protocol: Modbus/TCP, NTP, http, https
Physics: Ethernet 100BaseTX
Mode: 10/100 Mbit/s, full/half duplex, auto-negotiation

IEC61850 via RJ45 sockets, 2 equivalent ports
Protocol: IEC61850, NTP
Physics: Ethernet 100BaseTX
Mode: 10/100 Mbit/s, full/half duplex, auto-negotiation

Modbus/RTU via plug-in terminal (A, B, C/X)
Protocol: Modbus/RTU
Physics: RS-485, max. 1200m (4000 ft)
Baud rate: 9'600, 19'200, 38'400, 57'600, 115'200 Baud
Number of participants: ≤ 32

Internal clock (RTC)

Uncertainty: ± 2 minutes / month (15 up to 30°C)
Synchronization: none, via Ethernet ([NTP protocol](#)) or [GPS](#)
Running reserve: > 10 years

Uninterruptible power supply (UPS)

Type: VARTA Easy Pack EZPAckL, UL listed MH16707
Nominal voltage: 3.7V
Capacity: 1150 mAh min., 4.5 Wh
Operating duration: 5 times 3 minutes
Life time: 3 up to 5 years, depending on operating and ambient conditions

Ambient conditions, general information

| | |
|--------------------------------|--|
| Operating temperature: | <ul style="list-style-type: none">• Device without UPS: -10 up to <u>15 up to 30</u> up to + 55°C• Device with UPS: 0 up to <u>15 up to 30</u> up to + 35°C |
| Storage temperature: | Base device: -25 up to + 70°C; Battery pack UPS: -20...60°C (<1 month); -20°...45°C (< 3 months); -20...30°C (< 1 year) |
| Temperature influence: | 0.5 x measurement uncertainty per 10 K |
| Long term drift: | 0.5 x measurement uncertainty per year |
| Others: | Usage group II (EN 60 688) |
| Relative humidity: | < 95% no condensation |
| Altitude: | ≤ 2000 m max. |
| Device to be used indoor only! | |

Mechanical attributes

| | |
|---------------------|--|
| Housing material: | Polycarbonate (Makrolon) |
| Flammability class: | V-0 acc. UL94, non-dripping, free of halogen |
| Weight: | 800 g (CU3000), 600g (CU5000) |
| Dimensions: | Dimensional drawings |

Vibration withstand (test according to DIN EN 60 068-2-6)

| | |
|-------------------|---|
| Acceleration: | <ul style="list-style-type: none">• Device with display: ± 0.25 g (operating); 1.20 g (storage)• Device without display: ± 2 g |
| Frequency range: | 10 ... 150 ... 10 Hz, rate of frequency sweep: 1 octave/minute |
| Number of cycles: | 10 in each of the 3 axes |

Safety

The current inputs are galvanically isolated from each other

Protection class: II (protective insulation, voltage inputs via protective impedance)

Pollution degree: 2

Protection: Front: IP40, IP54 (CU3000 with sealing joint); Housing: IP30; Terminals: IP20

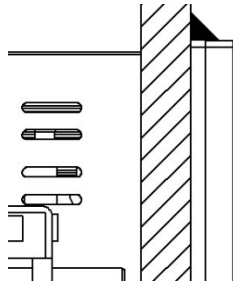

IP54 remark

Sealing joint must be applied on the entire circumference of the housing; tested for CE compliance only.

Rated voltage (versus earth): Power supply V1: 100...230V AC / DC (CU3000) or 100...230V AC / DC (CU5000)
Power supply V2: 24...48V DC $\pm 15\%$
Power supply V3: 110...200V AC / 110...200V DC (CU3000)
Relay: 250 V AC (OVC III)
I/O's: 24 V DC

Test voltages: Test time 60s, acc. IEC/EN 61010-1 (2011)

- power supply versus inputs U ¹⁾: 3600V AC
- power supply versus inputs I: 3000V AC
- power supply V1 versus bus, I/O's: 3000V AC
- inputs U versus inputs I: 1800V AC
- inputs U versus bus, I/O's ¹⁾: 3600V AC
- inputs I versus bus, I/O's: 3000V AC
- inputs I versus inputs I: 1500V AC

¹⁾ During type test only, with all protective impedances removed

The device uses the principle of protective impedance for the voltage inputs to ensure protection against electric shock. All circuits of the device are tested during final inspection.



Prior to performing high voltage or isolation tests involving the voltage inputs, all output connections of the device, especially analog outputs, digital and relay outputs as well as Modbus and Ethernet interface, must be removed. A possible high-voltage test between input and output circuits must be limited to 500V DC, otherwise electronic components can be damaged.

Applied regulations, standards and directives

| | |
|------------------------------------|--|
| IEC/EN 61010-1 | Safety regulations for electrical measuring, control and laboratory equipment |
| IEC/EN 61000-4-30 Ed.3 | Power quality measurement methods |
| IEC/EN 61000-4-7 | General guide on harmonics and interharmonics measurements |
| EN 50160 | Voltage characteristics of electricity supplied by public distribution systems |
| IEC/EN 60688 | Electrical measuring transducers for converting AC electrical variables into analog or digital signals |
| DIN 40110 | AC quantities |
| IEC/EN 60068-2-1/ -2/-3/-6/-27: | Ambient tests -1 Cold, -2 Dry heat, -3 Damp heat, -6 Vibration, -27 Shock |
| IEC/EN 61000-6-2 61000-6-4 | Electromagnetic compatibility (EMC) Generic standards for industrial environment |
| IEC/EN 61131-2 | Programmable controllers - equipment, requirements and tests (digital inputs/outputs 12/24V DC) |
| IEC/EN 61326 | Electrical equipment for measurement, control and laboratory use - EMC requirements |
| IEC/EN 62053-22 | Static meters for AC active energy (classes 0,1S, 0,2S and 0,5S) |
| IEC/EN 62053-24 | Static meters for reactive energy at fundamental frequency (classes 0,5S, 1S, 1, 2 and 3) |
| IEC/EN 62053-31 | Pulse output devices for electromechanical and electronic meters (S0 output) |
| IEC/EN 60529 | Protection type by case |
| UL94 | Tests for flammability of plastic materials for parts in devices and appliances |
| 2011/65/EU (RoHS) | EU directive on the restriction of the use of certain hazardous substances |

Warning

This is a class A product. In a domestic environment this product may cause radio interference in which case the user may be required to take adequate measures.

This device complies with part 15 of the FCC:

Operation is subject to the following two conditions: (1) This device may not cause harmful interference, and (2) this device must accept any interference received, including interference that may cause undesired operation.

This Class A digital apparatus complies with Canadian ICES-0003.

11. Dimensional drawings

CENTRAX CU3000

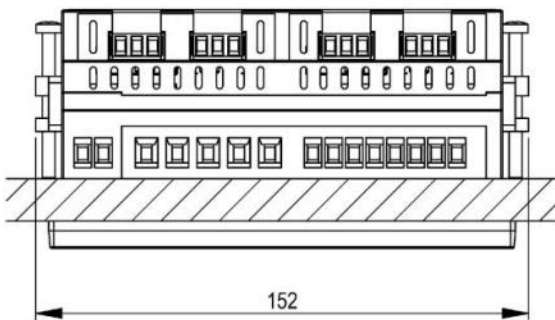
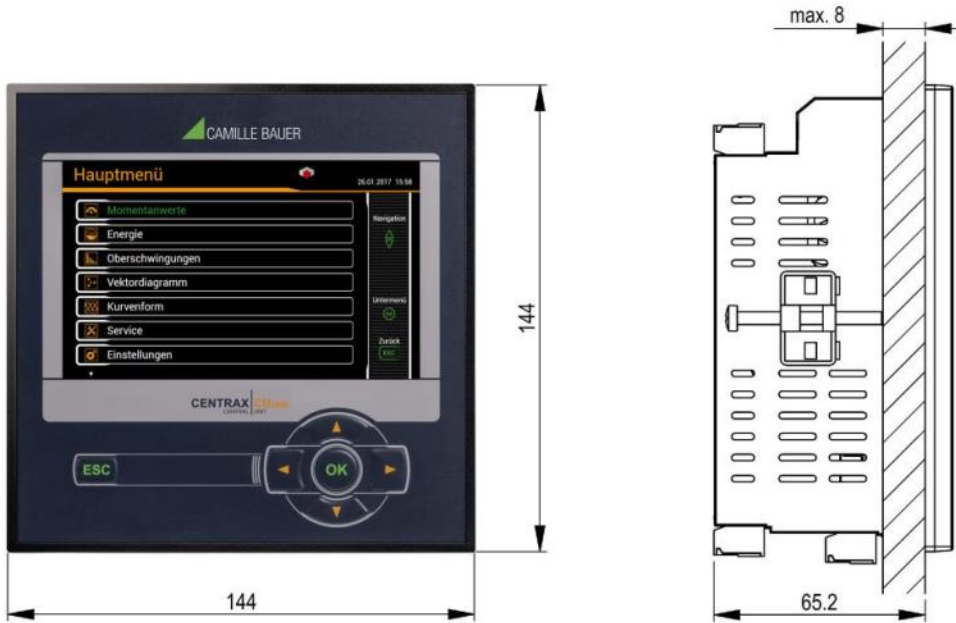

CENTRAX CU5000

Dimensions



All dimensions in [mm]

Annex

A Description of measured quantities

Used abbreviations

- 1L Single phase system
- 2L Split phase; system with 2 phases and center tap
- 3Lb 3-wire system with balanced load
- 3Lb.P 3-wire system with balanced load, phase shift (only 2 voltages connected)
- 3Lu 3-wire system with unbalanced load
- 3Lu.A 3-wire system with unbalanced load, Aron connection (only 2 currents connected)
- 4Lb 4-wire system with balanced load
- 4Lu 4-wire system with unbalanced load
- 4Lu.O 4-wire system with unbalanced load, Open-Y (reduced voltage connection)

A1 Basic measurements

The basic measured quantities are calculated each 200ms by determining an average over 10 cycles at 50Hz or 12 cycles at 60Hz. If a measurement is available depends on the selected system.

Depending on the measured quantity also minimum and maximum values are determined and non-volatile stored with timestamp. These values may be reset by the user via display, see [resetting of measurements](#).

| Measurement | present | max | min | 1L | 2L | 3Lb | 3Lb.P | 3Lu | 3Lu.A | 4Lb | 4Lu.O | 4Lu |
|--|---------|-----|-----|----|----|-----|-------|-----|-------|-----|-------|-----|
| Voltage U | • | • | • | √ | √ | | √ | | | √ | | |
| Voltage U _{1N} | • | • | • | | √ | | | | | | √ | √ |
| Voltage U _{2N} | • | • | • | | √ | | | | | | √ | √ |
| Voltage U _{3N} | • | • | • | | | | | | | | √ | √ |
| Voltage U ₁₂ | • | • | • | | | √ | | √ | √ | | √ | √ |
| Voltage U ₂₃ | • | • | • | | | √ | | √ | √ | | √ | √ |
| Voltage U ₃₁ | • | • | • | | | √ | | √ | √ | | √ | √ |
| Voltage U _{NE} ³⁾⁴⁾ | • | • | | √ | √ | √ | | √ | √ | √ | √ | √ |
| Current I | • | • | | √ | | √ | √ | | | √ | | |
| Current I ₁ | • | • | | | √ | | | √ | √ | | √ | √ |
| Current I ₂ | • | • | | | √ | | | √ | √ | | √ | √ |
| Current I ₃ | • | • | | | | | | √ | √ | | √ | √ |
| Neutral current I _N | • | • | | √ | √ | | | | | √ | √ | √ |
| Earth current I _{PE} (calculated) ³⁾ | • | • | | | | | | | | | √ | √ |
| Active power P | • | • | | √ | √ | √ | √ | √ | √ | √ | √ | √ |
| Active power P ₁ | • | • | | | √ | | | | | | √ | √ |
| Active power P ₂ | • | • | | | √ | | | | | | √ | √ |
| Active power P ₃ | • | • | | | | | | | | | √ | √ |
| Fundamental active power P(H1) | • | • | | √ | √ | √ | √ | √ | √ | √ | √ | √ |
| Fundamental active power P ₁ (H1) | • | • | | | √ | | | | | | √ | √ |
| Fundamental active power P ₂ (H1) | • | • | | | √ | | | | | | √ | √ |
| Fundamental active power P ₃ (H1) | • | • | | | | | | | | | √ | √ |
| Total reactive power Q | • | • | | √ | √ | √ | √ | √ | √ | √ | √ | √ |
| Total reactive power Q ₁ | • | • | | | √ | | | | | | √ | √ |
| Total reactive power Q ₂ | • | • | | | √ | | | | | | √ | √ |
| Total reactive power Q ₃ | • | • | | | | | | | | | √ | √ |
| Distortion reactive power D | • | • | | √ | √ | √ | √ | √ | √ | √ | √ | √ |
| Distortion reactive power D ₁ | • | • | | | √ | | | | | | √ | √ |
| Distortion reactive power D ₂ | • | • | | | √ | | | | | | √ | √ |
| Distortion reactive power D ₃ | • | • | | | | | | | | | √ | √ |
| Fundamental reactive power Q(H1) | • | • | | √ | √ | √ | √ | √ | √ | √ | √ | √ |
| Fundamental reactive power Q ₁ (H1) | • | • | | | √ | | | | | | √ | √ |
| Fundamental reactive power Q ₂ (H1) | • | • | | | √ | | | | | | √ | √ |
| Fundamental reactive power Q ₃ (H1) | • | • | | | | | | | | | √ | √ |

| Measurement | present | max | min | 1L | 2L | 3Lb | 3Lb.P | 3Lu | 3Lu.A | 4Lb | 4Lu.O | 4Lu |
|-------------------------------------|---------|-----|-----|----|----|-----|-------|-----|-------|-----|-------|-----|
| Apparent power S | • | • | | √ | √ | √ | √ | √ | √ | √ | √ | √ |
| Apparent power S1 | • | • | | | √ | | | | | | √ | √ |
| Apparent power S2 | • | • | | | √ | | | | | | √ | √ |
| Apparent power S3 | • | • | | | | | | | | | √ | √ |
| Fundamental apparent power S(H1) | • | • | | √ | √ | √ | √ | √ | √ | √ | √ | √ |
| Fundamental apparent power S1(H1) | • | • | | | √ | | | | | | √ | √ |
| Fundamental apparent power S2(H1) | • | • | | | √ | | | | | | √ | √ |
| Fundamental apparent power S3(H1) | • | • | | | | | | | | | √ | √ |
| Frequency F | • | • | • | √ | √ | √ | √ | √ | √ | √ | √ | √ |
| Power factor PF | • | | | √ | √ | √ | √ | √ | √ | √ | √ | √ |
| Power factor PF1 | • | | | | √ | | | | | | √ | √ |
| Power factor PF2 | • | | | | √ | | | | | | √ | √ |
| Power factor PF3 | • | | | | | | | | | | √ | √ |
| PF quadrant I | | | • | √ | √ | √ | √ | √ | √ | √ | √ | √ |
| PF quadrant II | | | • | √ | √ | √ | √ | √ | √ | √ | √ | √ |
| PF quadrant III | | | • | √ | √ | √ | √ | √ | √ | √ | √ | √ |
| PF quadrant IV | | | • | √ | √ | √ | √ | √ | √ | √ | √ | √ |
| Reactive power factor QF | • | | | √ | √ | √ | √ | √ | √ | √ | √ | √ |
| Reactive power factor QF1 | • | | | | √ | | | | | | √ | √ |
| Reactive power factor QF2 | • | | | | √ | | | | | | √ | √ |
| Reactive power factor QF3 | • | | | | | | | | | | √ | √ |
| Load factor LF | • | | | √ | √ | √ | √ | √ | √ | √ | √ | √ |
| Load factor LF1 | • | | | | √ | | | | | | √ | √ |
| Load factor LF2 | • | | | | √ | | | | | | √ | √ |
| Load factor LF3 | • | | | | | | | | | | √ | √ |
| cosφ (H1) | • | | | √ | √ | √ | √ | √ | √ | √ | √ | √ |
| cosφ L1 (H1) | • | | | | √ | | | | | | √ | √ |
| cosφ L2 (H1) | • | | | | √ | | | | | | √ | √ |
| cosφ L3 (H1) | • | | | | | | | | | | √ | √ |
| cosφ (H1) quadrant I | | | • | √ | √ | √ | √ | √ | √ | √ | √ | √ |
| cosφ (H1) quadrant II | | | • | √ | √ | √ | √ | √ | √ | √ | √ | √ |
| cosφ (H1) quadrant III | | | • | √ | √ | √ | √ | √ | √ | √ | √ | √ |
| cosφ (H1) quadrant IV | | | • | √ | √ | √ | √ | √ | √ | √ | √ | √ |
| tanφ (H1) | • | | | √ | √ | √ | √ | √ | √ | √ | √ | √ |
| tanφ L1 (H1) | • | | | | √ | | | | | | √ | √ |
| tanφ L2 (H1) | • | | | | √ | | | | | | √ | √ |
| tanφ L3 (H1) | • | | | | | | | | | | √ | √ |
| $U_{mean}=(U1N+U2N)/2$ | • | | | | √ | | | | | | | |
| $U_{mean}=(U1N+U2N+U3N)/3$ | • | | | | | | | | | | | √ |
| $U_{mean}=(U12+U23+U31)/3$ | • | | | | | √ | | √ | √ | | | |
| $I_{mean}=(I1+I2)/2$ | • | | | | √ | | | | | | | |
| $I_{mean}=(I1+I2+I3)/3$ | • | | | | | | | √ | | | √ | √ |
| IMS, Average current with sign of P | • | | | √ | √ | √ | √ | √ | √ | √ | √ | √ |
| Phase angle between U1 and U2 | • | | | | | √ | | √ | √ | | √ | √ |
| Phase angle between U2 and U3 | • | | | | | √ | | √ | √ | | √ | √ |
| Phase angle between U3 and U1 | • | | | | | √ | | √ | √ | | √ | √ |
| Angle between U and I | • | | | √ | | √ | √ | √ | √ | √ | | |
| Angle between U1 and I1 | • | | | | √ | | | | | | √ | √ |
| Angle between U2 and I2 | • | | | | √ | | | | | | √ | √ |
| Angle between U3 and I3 | • | | | | | | | | | | √ | √ |
| Maximum ΔU <> Um ¹⁾ | • | • | | | √ | √ | | √ | √ | | | √ |
| Maximum ΔI <> Im ²⁾ | • | • | | | √ | | | √ | | | √ | √ |

¹⁾ maximum deviation from the mean value of all voltages (see A3)

²⁾ maximum deviation from the mean value of all currents (see A3)

³⁾ AM3000 only

⁴⁾ For 3-wire systems: Homopolar voltage, only if its measurement has been activated

• Available via communication interface only

Reactive power

Most of the loads consume a combination of ohmic and inductive current from the power system. Reactive power arises by means of the inductive load. But the number of non-linear loads, such as RPM regulated drives, rectifiers, thyristor controlled systems or fluorescent lamps, is increasing. They cause non-sinusoidal AC currents, which may be represented as a sum of harmonics. Thus the reactive power to transmit increases and leads to higher transmission losses and higher energy costs. This part of the reactive power is called distortion reactive power.

Normally reactive power is unwanted, because there is no usable active component in it. Because the transmission of reactive power over long distances is uneconomic, it makes sense to install compensation systems close to the consumers. So transmission capacities may be used better and losses and voltage drops by means of harmonic currents can be avoided.

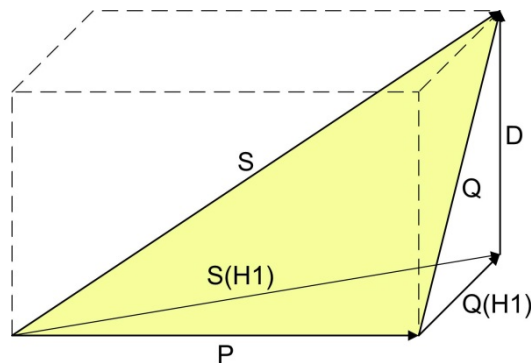

- P: Active power
- S: Apparent power including harmonic components
- S1: Fundamental apparent power
- Q: Total reactive power
- Q(H1): Fundamental reactive power
- D: Distortion reactive power

The reactive power may be divided in a fundamental and a distortion component. Only the fundamental reactive power may be compensated directly by means of the classical capacitive method. The distortion components have to be combated using inductors or active harmonic conditioners.

The **load factor PF** is the relation between active power P and apparent power S, including all possibly existing harmonic parts. This factor is often called $\cos\varphi$, which is only partly correct. The PF corresponds to the **cos φ** only, if there is no harmonic content present in the system. So the **cos φ** represents the relation between the active power P and the fundamental apparent power S(H1).

The **tan φ** is often used as a target quantity for the capacitive reactive power compensation. It corresponds to the relation of the fundamental reactive power Q(H1) and the active power P.

Power factors

The **power factor PF** gives the relation between active and apparent power. If there are no harmonics present in the system, it corresponds to the $\cos\varphi$. The PF has a range of -1...0...+1, where the sign gives the direction of energy flow.

The **load factor LF** is a quantity derived from the PF, which allows making a statement about the load type. Only this way it's possible to measure a range like 0.5 capacitive ... 1 ... 0.5 inductive in a non-ambiguous way.

The **reactive power factor QF** gives the relation between reactive and apparent power.

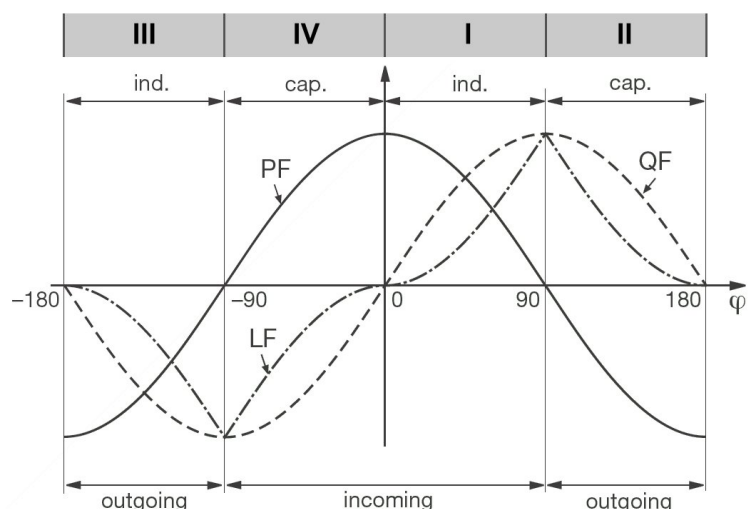

Example from the perspective of an energy consumer

Zero displacement voltage U_{NE}

Starting from the generating system with star point E (which is normally earthed), the star point (N) on load side is shifted in case of unbalanced load. The zero displacement voltage between E and N may be determined by a vectorial addition of the voltage vectors of the three phases:

$$\underline{U}_{NE} = - (\underline{U}_{1N} + \underline{U}_{2N} + \underline{U}_{3N}) / 3$$

A displacement voltage may also occur due to harmonics of order 3, 9, 15, 21 etc., because the dedicated currents add in the neutral wire.

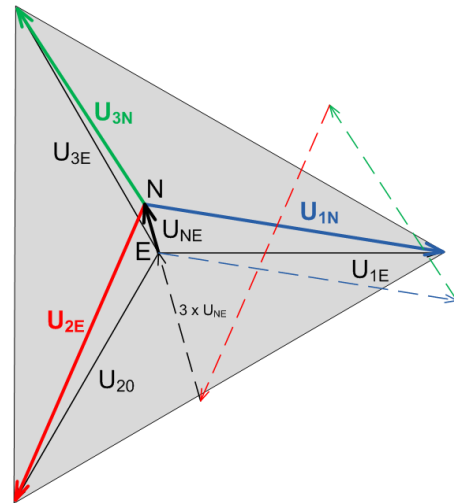

Earth fault monitoring in IT systems

Via the determination of the zero displacement voltage it's possible to detect a first earth fault in an unearthed IT system. To do so, the device is configured for measurement in a 4-wire system with unbalanced load and the neutral connector is connected to earth. In case of a single phase earth fault there is a resulting zero displacement voltage of $U_{LL} / \sqrt{3}$. The alarming may be done e.g. by means of a relay output.

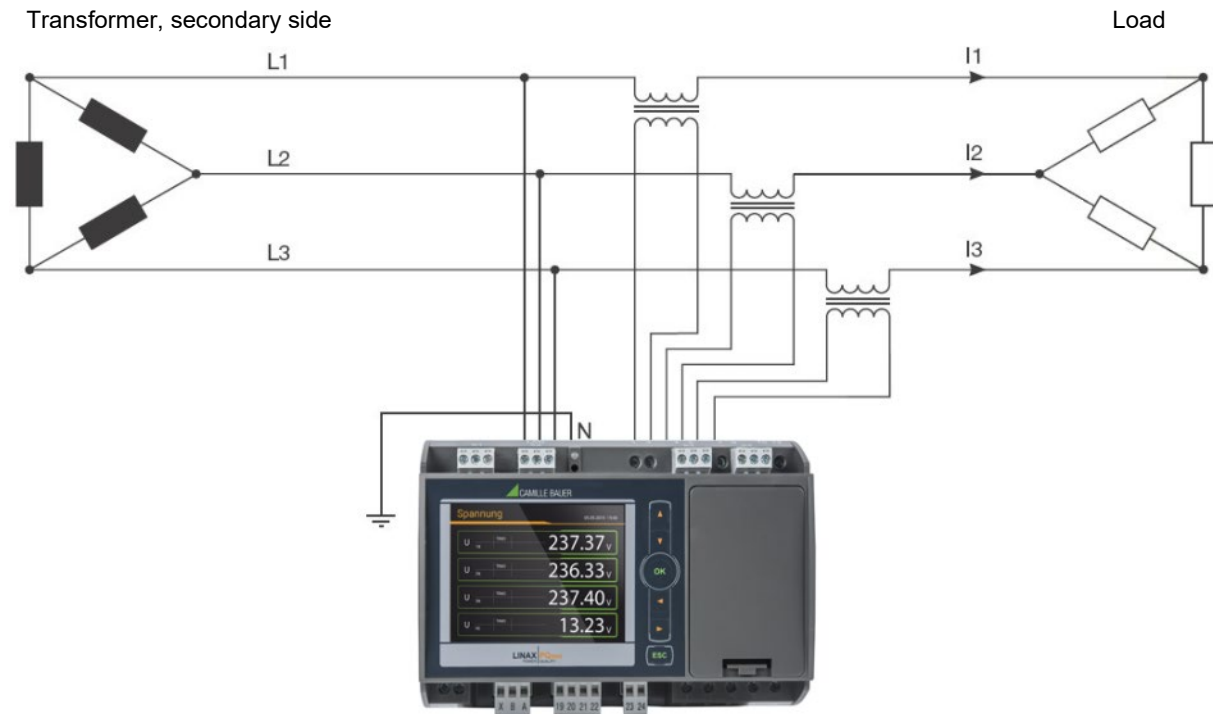

Because in case of a fault the voltage triangle formed by the three phases does not change, the voltage and current measurements as well as the system power values will still be measured and displayed correctly. Also the meters carry on to work as expected.

The method is suited to detect a fault condition during normal operation. A declination of the isolation resistance may not be detected this way. This should be measured during a periodic control of the system using a mobile system.

Another possibility to analyze fault conditions in a grid offers the method of the [symmetrical components](#) as described in A3.

A2 Harmonic analysis

The harmonic analysis is performed according IEC 61000-4-7 over 10 cycles at 50Hz or 12 cycles at 60Hz. If a measured quantity is available depends on the selected system.

| Measurement | present | max | 1L | 2L | 3Lb | 3Lb.P | 3Lu | 3Lu.A | 4Lb | 4Lu.O | 4Lu |
|---|---------|-----|----|----|-----|-------|-----|-------|-----|-------|-----|
| THD Voltage U1N/U | • | • | √ | √ | | √ | | | √ | √ | √ |
| THD Voltage U2N | • | • | | √ | | | | | | √ | √ |
| THD Voltage U3N | • | • | | | | | | | | √ | √ |
| THD Voltage U12 | • | • | | | √ | | √ | √ | | | |
| THD Voltage U23 | • | • | | | √ | | √ | √ | | | |
| THD Voltage U31 | • | • | | | √ | | √ | √ | | | |
| THD Current I1/I | • | • | √ | √ | √ | √ | √ | √ | √ | √ | √ |
| THD Current I2 | • | • | | √ | | | √ | √ | | √ | √ |
| THD Current I3 | • | • | | | | | √ | √ | | √ | √ |
| TDD Current I1/I | • | • | √ | √ | √ | √ | √ | √ | √ | √ | √ |
| TDD Current I2 | • | • | | √ | | | √ | √ | | √ | √ |
| TDD Current I3 | • | • | | | | | √ | √ | | √ | √ |
| Harmonic contents 2 nd ...50 th U1N/U | • | • | √ | √ | | √ | | | √ | √ | √ |
| Harmonic contents 2 nd ...50 th U2N | • | • | | √ | | | | | | √ | √ |
| Harmonic contents 2 nd ...50 th U3N | • | • | | | | | | | | √ | √ |
| Harmonic contents 2 nd ...50 th U12 | • | • | | | √ | | √ | √ | | | |
| Harmonic contents 2 nd ...50 th U23 | • | • | | | √ | | √ | √ | | | |
| Harmonic contents 2 nd ...50 th U31 | • | • | | | √ | | √ | √ | | | |
| Harmonic contents 2 nd ...50 th I1/I | • | • | √ | √ | √ | √ | √ | √ | √ | √ | √ |
| Harmonic contents 2 nd ...50 th I2 | • | • | | √ | | | √ | √ | | √ | √ |
| Harmonic contents 2 nd ...50 th I3 | • | • | | | | | √ | √ | | √ | √ |

Harmonic contents are available up to the 89th (50Hz) or 75th (60Hz) on the Modbus interface

• Available via communication interface only

Harmonics

Harmonics are multiples of the fundamental or system frequency. They arise if non-linear loads, such as RPM regulated drives, rectifiers, thyristor controlled systems or fluorescent lamps are present in the power system. Thus undesired side effects occur, such as additional thermal stress to operational resources or electrical mains, which lead to an advanced aging or even damage. Also the reliability of sensitive loads can be affected and unexplainable disturbances may occur. In industrial networks the image of the harmonics gives good information about the kind of loads connected. See also:

► [Increase of reactive power due to harmonic currents](#)

TDD (Total Demand Distortion)

The complete harmonic content of the currents is calculated additionally as Total Demand Distortion, briefly TDD. This value is scaled to the rated current or rated power. Only this way it's possible to estimate the influence of the current harmonics on the connected equipment correctly.

Maximum values

The maximum values of the harmonic analysis arise from the monitoring of THD and TDD. The maximum values of individual harmonics are not monitored separately, but are stored if a maximum value of THD or TDD is detected. The image of the maximum harmonics therefore always corresponds to the dedicated THD or TDD.



The accuracy of the harmonic analysis strongly depends on the quality of the current and voltage transformers possibly used. In the harmonics range transformers normally change both, the amplitude and the phase of the signals to measure. It's valid: The higher the frequency of the harmonic, the higher its damping or phase shift.

A3 System imbalance

| Measured quantity | present | max | 1L | 2L | 3Lb | 3Lb.P | 3Lu | 3Lu.A | 4Lb | 4Lu.O | 4Lu |
|----------------------------|---------|-----|----|----|-----|-------|-----|-------|-----|-------|-----|
| UR1: Positive sequence [V] | • | | | | √ | | √ | √ | | | √ |
| UR2: Negative sequence [V] | • | | | | √ | | √ | √ | | | √ |
| U0: Zero sequence [V] | • | | | | | | | | | | √ |
| U: Imbalance UR2/UR1 | • | • | | | √ | | √ | √ | | | √ |
| U: Imbalance U0/UR1 | • | • | | | | | | | | | √ |
| IR1: Positive sequence [A] | • | | | | | | √ | | | √ | √ |
| IR2: Negative sequence [A] | • | | | | | | √ | | | √ | √ |
| I0: Zero sequence [A] | • | | | | | | | | | √ | √ |
| I: Imbalance IR2/IR1 | • | • | | | | | √ | | | √ | √ |
| I: Imbalance I0/IR1 | • | • | | | | | | | | √ | √ |

• Available via communication interface only

Imbalance in three-phase systems may occur due to single-phase loads, but also due to failures, such as e.g. the blowing of a fuse, an earth fault, a phase failure or an isolation defect. Also harmonics of the 3rd, 9th, 15th, 21st etc. order, which add in the neutral wire, may lead to imbalance. Operating resources dimensioned to rated values, such as three-phase generators, transformers or motors on load side, may be excessively stressed by imbalance. So a shorter life cycle, a damage or failure due to thermal stress can result. Therefore monitoring imbalance helps to reduce the costs for maintenance and extends the undisturbed operating time of the used resources.

Imbalance or unbalanced load relays use different measurement principles. One of them is the approach of the symmetrical components, the other one calculates the maximum deviation from the mean-value of the three phase values. The results of these methods are not equal and don't have the same intention. Both of these principles are implemented in the device.

Symmetrical components (acc. Fortescue)

The imbalance calculation method by means of the symmetrical components is ambitious and intensive to calculate. The results may be used for disturbance analysis and for protection purposes in three-phase systems. The real existing system is divided in symmetrical system parts: A positive sequence, a negative sequence and (for systems with neutral conductor) a zero sequence system. The approach is easiest to understand for rotating machines. The positive sequence represents a positive rotating field, the negative sequence a negative (braking) rotating field with opposite sense of direction. Therefore the negative sequence prevents that the machine can generate the full turning moment. For e.g. generators the maximum permissible current imbalance is typically limited to a value of 8...12%.

Maximum deviation from the mean value

The calculation of the maximum deviation from the mean value of the phase currents or phase voltages gives the information if a grid or substation is imbalanced loaded. The results are independent of rated values and the present load situation. So a more symmetrical system can be aspired, e.g. by changing loads from one phase to another.

Also failure detection is possible. The capacitors used in compensation systems are wear parts, which fail quite often and then have to be replaced. When using three phase power capacitors all phases will be compensated equally which leads to almost identical currents flowing through the capacitors, if the system load is comparable. By monitoring the current imbalance it's then possible to estimate if a capacitor failure is present.

The maximum deviations are calculated in the same steps as the instantaneous values and therefore are arranged there ([see A1](#)).

A4 Mean values and trend

| Measured quantity | | Present | Trend | max | min | History |
|------------------------|----------------------------|---------|-------|-----|-----|---------|
| Active power I+IV | 10s...60min. ¹⁾ | • | • | • | • | 5 |
| Active power II+III | 10s...60min. ¹⁾ | • | • | • | • | 5 |
| Reactive power I+II | 10s...60min. ¹⁾ | • | • | • | • | 5 |
| Reactive power III+IV | 10s...60min. ¹⁾ | • | • | • | • | 5 |
| Apparent power | 10s...60min. ¹⁾ | • | • | • | • | 5 |
| Mean value quantity 1 | 10s...60min. ²⁾ | • | • | • | • | 1 |
| | | | | | | |
| Mean value quantity 12 | 10s...60min. ²⁾ | • | • | • | • | 1 |

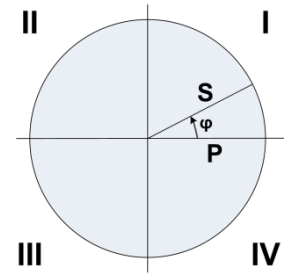

¹⁾ Interval time t1 ²⁾ Interval time t2

The device calculates automatically the mean values of all system power quantities. In addition up to 12 further mean value quantities can be freely selected.

Calculating the mean-values

The mean value calculation is performed via integration of the measured instantaneous values over a configurable averaging interval. The interval time may be selected in the range from 10 seconds up to one hour. Possible interim values are set the way that a multiple of it is equal to a minute or an hour. Mean values of power quantities (interval time t1) and free quantities (interval time t2) may have different averaging intervals.

Synchronization

For the synchronization of the averaging intervals the internal clock or an external signal via digital input may be used. In case of an external synchronization the interval should be within the given range of one second up to one hour. The synchronization is important for making e.g. the mean value of power quantities on generating and demand side comparable.

Trend

The estimated final value (trend) of mean values is determined by weighted addition of measurements of the past and the present interval. It serves for early detection of a possible exceeding of a given maximum value. This can then be avoided, e.g. by switching off an active load.

History

For mean values of system powers the last 5 interval values may be displayed on the device or read via interface. For configurable quantities the value of the last interval is provided via communication interface.

Bimetal current

This measured quantity serves for measuring the long-term effect of the current, e.g. for monitoring the warming of a current-carrying line. To do so, an exponential function is used, similar to the charging curve of a capacitor. The response time of the bimetal function can be freely selected, but normally it corresponds to the interval for determining the power mean-values.

| Measured quantity | | Present | max | 1L | 2L | 3Lb | 3Lb.P | 3Lu | 3Lu.A | 4Lb | 4Lu.O | 4Lu |
|----------------------|--------------------------|---------|-----|----|----|-----|-------|-----|-------|-----|-------|-----|
| Bimetal current IB, | 1...60min. ³⁾ | • | • | √ | | √ | √ | | | √ | | |
| Bimetal current IB1, | 1...60min. ³⁾ | • | • | | √ | | | √ | √ | | √ | √ |
| Bimetal current IB2, | 1...60min. ³⁾ | • | • | | √ | | | √ | √ | | √ | √ |
| Bimetal current IB3, | 1...60min. ³⁾ | • | • | | | | | √ | √ | | √ | √ |

³⁾ Interval time t3

A5 Meters

| Measured quantity | 1L | 2L | 3Lb | 3Lb.P | 3Lu | 3Lu.A | 4Lb | 4Lu.O | 4Lu |
|-------------------------------------|--|----|-----|-------|-----|-------|-----|-------|-----|
| Active energy I+IV, high tariff | • | • | • | • | • | • | • | • | • |
| Active energy II+III, high tariff | • | • | • | • | • | • | • | • | • |
| Reactive energy I+II, high tariff | • | • | • | • | • | • | • | • | • |
| Reactive energy III+IV, high tariff | • | • | • | • | • | • | • | • | • |
| Active energy I+IV, low tariff | • | • | • | • | • | • | • | • | • |
| Active energy II+III, low tariff | • | • | • | • | • | • | • | • | • |
| Reactive energy I+II, low tariff | • | • | • | • | • | • | • | • | • |
| Reactive energy III+IV, low tariff | • | • | • | • | • | • | • | • | • |
| User configured meter 1 | Only basic quantities can be selected which are supported in the present system. | | | | | | | | |
| User configured meter 2 | | | | | | | | | |
| User configured meter 3 | | | | | | | | | |
| User configured meter 4 | | | | | | | | | |
| User configured meter 5 | | | | | | | | | |
| User configured meter 6 | | | | | | | | | |
| User configured meter 7 | | | | | | | | | |
| User configured meter 8 | | | | | | | | | |
| User configured meter 9 | | | | | | | | | |
| User configured meter 10 | | | | | | | | | |
| User configured meter 11 | | | | | | | | | |
| User configured meter 12 | | | | | | | | | |

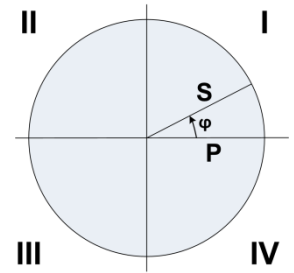

Standard meters

The meters for active and reactive energy of the system are always active.

User configured meters

To each of these meters the user can freely assign a basic quantity.

Programmable meter resolution



For all meters the resolution (displayed unit) can be selected almost freely. This way, applications with short measurement times, e.g. energy consumption of a working day or shift, can be realized. The smaller the basic unit is selected, the faster the meter overflow is reached.

B Display matrices

B0 Used abbreviations for the measurements

Instantaneous values















| Name | Measurement identification | Unit | Description |
|-------|--|------|--|
| U | U TRMS | V | Voltage system |
| U1N | U 1N TRMS | V | Voltage between phase L1 and neutral |
| U2N | U 2N TRMS | V | Voltage between phase L2 and neutral |
| U3N | U 3N TRMS | V | Voltage between phase L3 and neutral |
| U12 | U 12 TRMS | V | Voltage between phases L1 and L2 |
| U23 | U 23 TRMS | V | Voltage between phases L2 and L3 |
| U31 | U 31 TRMS | V | Voltage between phases L3 and L1 |
| UNE | U NE TRMS | V | Zero displacement voltage 4-wire systems |
| I | I TRMS | A | Current system |
| I1 | I 1 TRMS | A | Current phase L1 |
| I2 | I 2 TRMS | A | Current phase L2 |
| I3 | I 3 TRMS | A | Current phase L3 |
| IN | I N TRMS | A | Neutral current |
| IPE | I PE TRMS | | Earth current |
| P | P TRMS | W | Active power system (P=P1+P2+P3) |
| P1 | P 1 TRMS | W | Active power phase L1 |
| P2 | P 2 TRMS | W | Active power phase L2 |
| P3 | P 3 TRMS | W | Active power phase L3 |
| Q | Q TRMS | var | Reactive power system (Q=Q1+Q2+Q3) |
| Q1 | Q 1 TRMS | var | Reactive power phase L1 |
| Q2 | Q 2 TRMS | var | Reactive power phase L2 |
| Q3 | Q 3 TRMS | var | Reactive power phase L3 |
| S | S TRMS | VA | Apparent power system |
| S1 | S 1 TRMS | VA | Apparent power phase L1 |
| S2 | S 2 TRMS | VA | Apparent power phase L2 |
| S3 | S 3 TRMS | VA | Apparent power phase L3 |
| F | F TRMS | Hz | System frequency |
| PF | PF TRMS | | Active power factor P/S |
| PF1 | PF 1 TRMS | | Active power factor P1/S1 |
| PF2 | PF 2 TRMS | | Active power factor P2/S2 |
| PF3 | PF 3 TRMS | | Active power factor P3/S3 |
| QF | QF TRMS | | Reactive power factor Q / S |
| QF1 | QF 1 TRMS | | Reactive power factor Q1 / S1 |
| QF2 | QF 2 TRMS | | Reactive power factor Q2 / S2 |
| QF3 | QF 3 TRMS | | Reactive power factor Q3 / S3 |
| LF | LF TRMS | | Load factor system |
| LF1 | LF 1 TRMS | | Load factor phase L1 |
| LF2 | LF 2 TRMS | | Load factor phase L2 |
| LF3 | LF 3 TRMS | | Load factor phase L3 |
| UR1 | U pos SEQ | V | Positive sequence voltage |
| UR2 | U neg SEQ | V | Negative sequence voltage |
| U0 | U zero SEQ | V | Zero sequence voltage |
| IR1 | I pos SEQ | A | Positive sequence current |
| IR2 | I neg SEQ | A | Negative sequence current |
| I0 | I zero SEQ | A | Zero sequence current |
| UR2R1 | U neg/pos UNB | % | Unbalance factor voltage UR2/UR1 |
| IR2R1 | I neg/pos UNB | % | Unbalance factor current IR2/IR1 |
| U0R1 | U zero/pos UNB | % | Unbalance factor voltage U0/UR1 |
| I0R1 | I zero/pos UNB | % | Unbalance factor current I0/IR1 |
| IMS | I  TRMS | A | Average current with sign of P |

Minimum and maximum of instantaneous values









| Name | Measurement identification | Unit | Description |
|-------------|----------------------------|------|---------------------------------------|
| U_MM | U TRMS ▲TS ▼TS | V | Minimum and maximum value of U |
| U1N_MM | U 1N TRMS ▲TS ▼TS | V | Minimum and maximum value of U1N |
| U2N_MM | U 2N TRMS ▲TS ▼TS | V | Minimum and maximum value of U2N |
| U3N_MM | U 3N TRMS ▲TS ▼TS | V | Minimum and maximum value of U3N |
| U12_MM | U 12 TRMS ▲TS ▼TS | V | Minimum and maximum value of U12 |
| U23_MM | U 23 TRMS ▲TS ▼TS | V | Minimum and maximum value of U23 |
| U31_MM | U 31 TRMS ▲TS ▼TS | V | Minimum and maximum value of U31 |
| UNE_MAX | U NE TRMS ▲TS ▼TS | V | Maximum value of UNE |
| I_MAX | I TRMS ▲TS | A | Maximum value of I |
| I1_MAX | I 1 TRMS ▲TS | A | Maximum value of I1 |
| I2_MAX | I 2 TRMS ▲TS | A | Maximum value of I2 |
| I3_MAX | I 3 TRMS ▲TS | A | Maximum value of I3 |
| IN_MAX | I N TRMS ▲TS | A | Maximum value of IN |
| IPE_MAX | I PE TRMS ▲TS | A | Maximum value of IPE |
| P_MAX | P TRMS ▲TS | W | Maximum value of P |
| P1_MAX | P 1 TRMS ▲TS | W | Maximum value of P1 |
| P2_MAX | P 2 TRMS ▲TS | W | Maximum value of P2 |
| P3_MAX | P 3 TRMS ▲TS | W | Maximum value of P3 |
| Q_MAX | Q TRMS ▲TS | var | Maximum value of Q |
| Q1_MAX | Q 1 TRMS ▲TS | var | Maximum value of Q1 |
| Q2_MAX | Q 2 TRMS ▲TS | var | Maximum value of Q2 |
| Q3_MAX | Q 3 TRMS ▲TS | var | Maximum value of Q3 |
| S_MAX | S TRMS ▲TS | VA | Maximum value of S |
| S1_MAX | S 1 TRMS ▲TS | VA | Maximum value of S1 |
| S2_MAX | S 2 TRMS ▲TS | VA | Maximum value of S2 |
| S3_MAX | S 3 TRMS ▲TS | VA | Maximum value of S3 |
| F_MM | F TRMS ▲TS | Hz | Minimum and maximum value of F |
| UR21_MAX | U neg/pos UNB ▲TS | % | Maximum value of UR2/UR1 |
| IR21_MAX | I neg/pos UNB ▲TS | % | Maximum value of IR2/IR1 |
| THD_U_MAX | U THD ▲TS | % | Max. Total Harmonic Distortion of U |
| THD_U1N_MAX | U 1N THD ▲TS | % | Max. Total Harmonic Distortion of U1N |
| THD_U2N_MAX | U 2N THD ▲TS | % | Max. Total Harmonic Distortion of U2N |
| THD_U3N_MAX | U 3N THD ▲TS | % | Max. Total Harmonic Distortion of U3N |
| THD_U12_MAX | U 12 THD ▲TS | % | Max. Total Harmonic Distortion of U12 |
| THD_U23_MAX | U 23 THD ▲TS | % | Max. Total Harmonic Distortion of U23 |
| THD_U31_MAX | U 31 THD ▲TS | % | Max. Total Harmonic Distortion of U31 |
| TDD_I_MAX | I TDD ▲TS | % | Max. Total Demand Distortion of I |
| TDD_I1_MAX | I 1 TDD ▲TS | % | Max. Total Demand Distortion of I1 |
| TDD_I2_MAX | I 2 TDD ▲TS | % | Max. Total Demand Distortion of I2 |
| TDD_I3_MAX | I 3 TDD ▲TS | % | Max. Total Demand Distortion of I3 |

TS: Timestamp of occurrence, e.g. 2014/09/17 11:12:03









Mean-values, trend and bimetal current

| Name | Measurement identification | Unit | Description |
|--------|--|------|---------------------------|
| M1 | (m) (p) (q)  (t2) | (mu) | Mean-value 1 |
| M2 | (m) (p) (q)  (t2) | (mu) | Mean-value 2 |
| | (m) (p) (q)  (t2) | (mu) | |
| M11 | (m) (p) (q)  (t2) | (mu) | Mean-value 11 |
| M12 | (m) (p) (q)  (t2) | (mu) | Mean-value 12 |
| TR_M1 | (m) (p) (q)  (t2) | (mu) | Trend mean-value 1 |
| TR_M2 | (m) (p) (q)  (t2) | (mu) | Trend mean-value 2 |
| | (m) (p) (q)  (t2) | (mu) | |
| TR_M11 | (m) (p) (q)  (t2) | (mu) | Trend mean-value 11 |
| TR_M12 | (m) (p) (q)  (t2) | (mu) | Trend mean-value 12 |
| IB | IB  (t3) | A | Bimetal current, system |
| IB1 | IB 1  (t3) | A | Bimetal current, phase L1 |
| IB2 | IB 2  (t3) | A | Bimetal current, phase L2 |
| IB3 | IB 3  (t3) | A | Bimetal current, phase L3 |

Minimum and maximum of mean-values and bimetal-current

| Name | Measurement identification | Unit | Description |
|---------|---|------|-----------------------------------|
| M1_MM | (m) (p) (q)  (t2) ▲ TS ▼ TS | .. | Min/Max mean-value 1 |
| M2_MM | (m) (p) (q)  (t2) ▲ TS ▼ TS | .. | Min/Max mean-value 2 |
| | (m) (p) (q)  (t2) ▲ TS ▼ TS | .. | |
| M11_MM | (m) (p) (q)  (t2) ▲ TS ▼ TS | .. | Min/Max mean-value 11 |
| M12_MM | (m) (p) (q)  (t2) ▲ TS ▼ TS | .. | Min/Max mean-value 12 |
| IB_MAX | IB  (t3) ▲ TS | A | Maximum bimetal current, system |
| IB1_MAX | IB 1  (t3) ▲ TS | A | Maximum Bimetal current, phase L1 |
| IB2_MAX | IB 2  (t3) ▲ TS | A | Maximum Bimetal current, phase L2 |
| IB3_MAX | IB 3  (t3) ▲ TS | A | Maximum Bimetal current, phase L3 |

Meters

| Name | Measurement identification | Unit | Description |
|--------------|---|------|--------------------------------|
| ΣP_I_IV_HT | P  ΣHT | Wh | Meter P I+IV, high tariff |
| ΣP_II_III_HT | P  ΣHT | Wh | Meter P II+III, high tariff |
| ΣQ_I_II_HT | Q  ΣHT | varh | Meter Q I+II, high tariff |
| ΣQ_III_IV_HT | Q  ΣHT | varh | Meter Q III+IV, high tariff |
| ΣP_I_IV_LT | P  ΣLT | Wh | Meter P I+IV, low tariff |
| ΣP_II_III_LT | P  ΣLT | Wh | Meter P II+III, low tariff |
| ΣQ_I_II_LT | Q  ΣLT | varh | Meter Q I+II, low tariff |
| ΣQ_III_IV_LT | Q  ΣLT | varh | Meter Q III+IV, low tariff |
| ΣMETER1 | (m) (p) (qg) Σ(T) | (mu) | User meter 1, tariff HT or LT |
| ΣMETER2 | (m) (p) (qg) Σ(T) | (mu) | User meter 2, tariff HT or LT |
| | (m) (p) (qg) Σ(T) | (mu) | |
| ΣMETER11 | (m) (p) (qg) Σ(T) | (mu) | User meter 11, tariff HT or LT |
| ΣMETER12 | (m) (p) (qg) Σ(T) | (mu) | User meter 12, tariff HT or LT |

(m): Short description of basic quantity, e.g. „P“

(p): Phase reference of the selected quantity, e.g. „1“

(q): Quadrant information, e.g. „I+IV“

(qg): Graphical quadrant information, e.g. 

(T): Associated tariff, e.g. „HT“ or „LT“





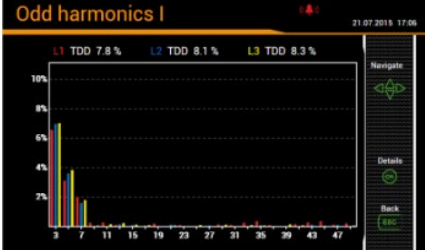
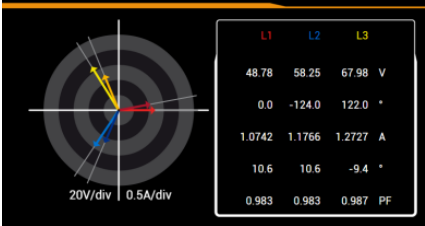

(mu): Unit of basic quantity

Graphical measurement displays







| Name | Presentation | Description |
|---------------|----------------|---|
| Px_TRIANGLE | | <p>Graphic of the power triangle consisting of:</p> <ul style="list-style-type: none"> Active, reactive and apparent power P_x, Q_x, S_x Distortion reactive power D_x Fundamental reactive power $Q_x(H1)$ $\cos(\varphi)$ of fundamental Active power factor PF_x |
| PF_MIN | | Graphic: Minimum active power factor PF in all 4 quadrants |
| Cφ_MIN | (as PF_MIN) | Graphic: Minimum $\cos(\varphi)$ in all 4 quadrants |
| I > m.1 / m.2 | | <p>Graphic: Present measurements and states of fault-current monitoring</p> <p><i>Data available only, if the device is equipped with at least one optional fault-current module.</i></p> |
| θ m.1 / m.2 | | <p>Graphic: Present measurements and states of temperature monitoring</p> <p><i>Data available only, if the device is equipped with at least one temperature module.</i></p> |
| MT_P_I_IV | | <p>Graphic mean-value P (I+IV)</p> <p>Trend, last 5 interval values, minimum and maximum</p> |
| MT_P_II_III | (as MT_P_I_IV) | Graphic mean-value P (II+III) Trend, last 5 interval values, minimum and maximum |
| MT_Q_I_II | (as MT_P_I_IV) | Graphic mean-value Q (I+II) Trend, last 5 interval values, minimum and maximum |
| MT_Q_III_IV | (as MT_P_I_IV) | Graphic mean-value Q (III+IV) Trend, last 5 interval values, minimum and maximum |
| MT_S | (as MT_P_I_IV) | Graphic mean-value S: Trend, last 5 interval values, minimum and maximum |

| | | |
|-----------|--|---|
| HO_IX |  | Graphic: Odd harmonics 3 rd up to 49 th + Total Harmonic Distortion of all currents |
| HO_UX | (as HO_IX) | Graphic: Odd harmonics 3 rd up to 49 th + Total Harmonic Distortion of all voltages |
| HE_IX | (as HO_IX) | Graphic: Even harmonics 2 nd up to 50 th + Total Harmonic Distortion of all currents |
| HE_UX | (as HO_IX) | Graphic: Even harmonics 2 nd up to 50 th + Total Harmonic Distortion of all voltages |
| HO_UX_MAX | (as HO_IX) | Graphic: Maximum values odd harmonics 3 rd up to 49 th + Total Harmonic Distortion of all voltages |
| HO_IX_MAX | (as HO_IX) | Graphic: Maximum values odd harmonics 3 rd up to 49 th + Total Harmonic Distortion of all currents |
| HE_UX_MAX | (as HO_IX) | Graphic: Maximum values even harmonics 2 nd up to 50 th + Total Harmonic Distortion of all voltages |
| HE_IX_MAX | (as HO_IX) | Graphic: Maximum values even harmonics 2 nd up to 50 th + Total Harmonic Distortion of all currents |
| PHASOR |  | Graphic: All current and voltage phasors with present load situation |







B1 Display matrices for single phase system

| Display menu | Corresponding matrix | | | | | | | | | | | | | | | | | | | | | | | | | | | | |
|--|--|---|-------------------------|---|-------------|----------------|-----------------|-------|------------|-------------------|-------------------------|-------|------------|------------|------------|-------|------------|--------|------------|-------|--------------|--------------|--------------|--------------|--------------|--------------|--------------|--------------|--------------|
|  Instantaneous values | <table border="1"> <tr> <td>U UNE F</td> <td>U_MM UNE_MAX F_MM</td> <td></td> <td></td> </tr> <tr> <td>I IN IMS</td> <td>I_MAX IN_MAX</td> <td></td> <td></td> </tr> <tr> <td>P Q S PF</td> <td>P_MAX Q_MAX S_MAX</td> <td></td> <td></td> </tr> <tr> <td>P_TRIANGLE</td> <td></td> <td></td> <td></td> </tr> <tr> <td>PF_MIN</td> <td>Cφ_MIN</td> <td></td> <td></td> </tr> <tr> <td>I> 1.1 / 1.2</td> <td>I> 2.1 / 2.2</td> <td>I> 3.1 / 3.2</td> <td>I> 4.1 / 4.2</td> </tr> <tr> <td>I∅ 1.1 / 1.2</td> <td>I∅ 2.1 / 2.2</td> <td>I∅ 3.1 / 3.2</td> <td>I∅ 4.1 / 4.2</td> </tr> </table> | U UNE F | U_MM UNE_MAX F_MM | | | I IN IMS | I_MAX IN_MAX | | | P Q S PF | P_MAX Q_MAX S_MAX | | | P_TRIANGLE | | | | PF_MIN | Cφ_MIN | | | I> 1.1 / 1.2 | I> 2.1 / 2.2 | I> 3.1 / 3.2 | I> 4.1 / 4.2 | I∅ 1.1 / 1.2 | I∅ 2.1 / 2.2 | I∅ 3.1 / 3.2 | I∅ 4.1 / 4.2 |
| U UNE F | U_MM UNE_MAX F_MM | | | | | | | | | | | | | | | | | | | | | | | | | | | | |
| I IN IMS | I_MAX IN_MAX | | | | | | | | | | | | | | | | | | | | | | | | | | | | |
| P Q S PF | P_MAX Q_MAX S_MAX | | | | | | | | | | | | | | | | | | | | | | | | | | | | |
| P_TRIANGLE | | | | | | | | | | | | | | | | | | | | | | | | | | | | | |
| PF_MIN | Cφ_MIN | | | | | | | | | | | | | | | | | | | | | | | | | | | | |
| I> 1.1 / 1.2 | I> 2.1 / 2.2 | I> 3.1 / 3.2 | I> 4.1 / 4.2 | | | | | | | | | | | | | | | | | | | | | | | | | | |
| I∅ 1.1 / 1.2 | I∅ 2.1 / 2.2 | I∅ 3.1 / 3.2 | I∅ 4.1 / 4.2 | | | | | | | | | | | | | | | | | | | | | | | | | | |
|  Energy Meter contents Standard meters | <table border="1"> <tr> <td>ΣP_I_IV_HT ΣP_I_IV_NT ΣP_II_III_NT ΣP_II_III_HT ΣQ_I_II_HT ΣQ_I_II_NT ΣQ_III_IV_HT ΣQ_I_II_NT</td> </tr> </table> | ΣP_I_IV_HT ΣP_I_IV_NT ΣP_II_III_NT ΣP_II_III_HT ΣQ_I_II_HT ΣQ_I_II_NT ΣQ_III_IV_HT ΣQ_I_II_NT | | | | | | | | | | | | | | | | | | | | | | | | | | | |
| ΣP_I_IV_HT ΣP_I_IV_NT ΣP_II_III_NT ΣP_II_III_HT ΣQ_I_II_HT ΣQ_I_II_NT ΣQ_III_IV_HT ΣQ_I_II_NT | | | | | | | | | | | | | | | | | | | | | | | | | | | | | |
|  Energy Meter contents User meters | <table border="1"> <tr> <td>ΣMETER1 ΣMETER2 ΣMETER3 ΣMETER4 ΣMETER5 ΣMETER6 ΣMETER7 ΣMETER8 ΣMETER9 ΣMETER10 ΣMETER11 ΣMETER12</td> </tr> </table> | ΣMETER1 ΣMETER2 ΣMETER3 ΣMETER4 ΣMETER5 ΣMETER6 ΣMETER7 ΣMETER8 ΣMETER9 ΣMETER10 ΣMETER11 ΣMETER12 | | | | | | | | | | | | | | | | | | | | | | | | | | | |
| ΣMETER1 ΣMETER2 ΣMETER3 ΣMETER4 ΣMETER5 ΣMETER6 ΣMETER7 ΣMETER8 ΣMETER9 ΣMETER10 ΣMETER11 ΣMETER12 | | | | | | | | | | | | | | | | | | | | | | | | | | | | | |
|  Energy Mean-values Power mean-values + trend | <table border="1"> <tr> <td>MT_P_I_IV</td> <td>MT_P_II_III</td> <td>MT_Q_I_II</td> <td>MT_Q_III_IV</td> <td>MT_S</td> </tr> </table> | MT_P_I_IV | MT_P_II_III | MT_Q_I_II | MT_Q_III_IV | MT_S | | | | | | | | | | | | | | | | | | | | | | | |
| MT_P_I_IV | MT_P_II_III | MT_Q_I_II | MT_Q_III_IV | MT_S | | | | | | | | | | | | | | | | | | | | | | | | | |
|  Energy Mean-values User mean-values + trend | <table border="1"> <tr> <td>M1 / TR_M1</td> <td>M1_MM</td> <td rowspan="12">For CU5000 divided into 2 images each</td> </tr> <tr> <td>M2 / TR_M2</td> <td>M2_MM</td> </tr> <tr> <td>M3 / TR_M3</td> <td>M3_MM</td> </tr> <tr> <td>M4 / TR_M4</td> <td>M4_MM</td> </tr> <tr> <td>M5 / TR_M5</td> <td>M5_MM</td> </tr> <tr> <td>M6 / TR_M6</td> <td>M6_MM</td> </tr> <tr> <td>M7 / TR_M7</td> <td>M7_MM</td> </tr> <tr> <td>M8 / TR_M8</td> <td>M8_MM</td> </tr> <tr> <td>M9 / TR_M9</td> <td>M9_MM</td> </tr> <tr> <td>M10 / TR_M10</td> <td>M10_MM</td> </tr> <tr> <td>M11 / TR_M11</td> <td>M11_MM</td> </tr> <tr> <td>M12 / TR_M12</td> <td>M12_MM</td> </tr> </table> | M1 / TR_M1 | M1_MM | For CU5000 divided into 2 images each | M2 / TR_M2 | M2_MM | M3 / TR_M3 | M3_MM | M4 / TR_M4 | M4_MM | M5 / TR_M5 | M5_MM | M6 / TR_M6 | M6_MM | M7 / TR_M7 | M7_MM | M8 / TR_M8 | M8_MM | M9 / TR_M9 | M9_MM | M10 / TR_M10 | M10_MM | M11 / TR_M11 | M11_MM | M12 / TR_M12 | M12_MM | | | |
| M1 / TR_M1 | M1_MM | For CU5000 divided into 2 images each | | | | | | | | | | | | | | | | | | | | | | | | | | | |
| M2 / TR_M2 | M2_MM | | | | | | | | | | | | | | | | | | | | | | | | | | | | |
| M3 / TR_M3 | M3_MM | | | | | | | | | | | | | | | | | | | | | | | | | | | | |
| M4 / TR_M4 | M4_MM | | | | | | | | | | | | | | | | | | | | | | | | | | | | |
| M5 / TR_M5 | M5_MM | | | | | | | | | | | | | | | | | | | | | | | | | | | | |
| M6 / TR_M6 | M6_MM | | | | | | | | | | | | | | | | | | | | | | | | | | | | |
| M7 / TR_M7 | M7_MM | | | | | | | | | | | | | | | | | | | | | | | | | | | | |
| M8 / TR_M8 | M8_MM | | | | | | | | | | | | | | | | | | | | | | | | | | | | |
| M9 / TR_M9 | M9_MM | | | | | | | | | | | | | | | | | | | | | | | | | | | | |
| M10 / TR_M10 | M10_MM | | | | | | | | | | | | | | | | | | | | | | | | | | | | |
| M11 / TR_M11 | M11_MM | | | | | | | | | | | | | | | | | | | | | | | | | | | | |
| M12 / TR_M12 | M12_MM | | | | | | | | | | | | | | | | | | | | | | | | | | | | |
|  Energy Bimetal current | <table border="1"> <tr> <td>IB1 IB2 IB1_MAX IB2_MAX</td> </tr> </table> | IB1 IB2 IB1_MAX IB2_MAX | | | | | | | | | | | | | | | | | | | | | | | | | | | |
| IB1 IB2 IB1_MAX IB2_MAX | | | | | | | | | | | | | | | | | | | | | | | | | | | | | |







B2 Display matrices for split-phase (two-phase) systems

| Display menu | Corresponding matrix | | | | | | | | | | | | | | | | | | | | | | | | | | | | | | | | | | | | | | | | | | | | | | | | | | | | | | | | | | | | | |
|--|--|---|--|---|--------------|------------|------------|--------------|------------|---------|------------|----------|------------|-------|------------|-------|------------|-------|------------|-------|--------------|--------|--------------|--------|--------------|--------|--------|--|--|-----|---------|--|--|---|----|----------------|--|---|----|----------------|---|----|----------------|----|----|---------------|------------|-------------|-------------|--|--------|--------|--|--|-------------|-------------|-------------|-------------|-------------|-------------|-------------|-------------|
|  Instantaneous values | <table border="1"> <tr> <td>U1N</td> <td>U1N_MM</td> <td></td> <td></td> </tr> <tr> <td>U2N</td> <td>U2N_MM</td> <td></td> <td></td> </tr> <tr> <td>U</td> <td>U_MM</td> <td></td> <td></td> </tr> <tr> <td>UNE</td> <td>UNE_MAX</td> <td></td> <td></td> </tr> <tr> <td>I1</td> <td>I1_MAX</td> <td></td> <td></td> </tr> <tr> <td>I2</td> <td>I2_MAX</td> <td></td> <td></td> </tr> <tr> <td>IN</td> <td>IN_MAX</td> <td></td> <td></td> </tr> <tr> <td>IPE</td> <td>IPE_MAX</td> <td></td> <td></td> </tr> <tr> <td>P</td> <td>P1</td> <td>P_MAX / P1_MAX</td> <td rowspan="4">For CU5000 divided into 2 images</td> </tr> <tr> <td>Q</td> <td>P2</td> <td>Q_MAX / P2_MAX</td> </tr> <tr> <td>F</td> <td>Q1</td> <td>S_MAX / Q1_MAX</td> </tr> <tr> <td>PF</td> <td>Q2</td> <td>F_MM / Q2_MAX</td> </tr> <tr> <td>P_TRIANGLE</td> <td>P1_TRIANGLE</td> <td>P2_TRIANGLE</td> <td></td> </tr> <tr> <td>PF_MIN</td> <td>Cφ_MIN</td> <td></td> <td></td> </tr> <tr> <td> > 1.1 / 1.2</td> <td> > 2.1 / 2.2</td> <td> > 3.1 / 3.2</td> <td> > 4.1 / 4.2</td> </tr> <tr> <td>∅ 1.1 / 1.2</td> <td>∅ 2.1 / 2.2</td> <td>∅ 3.1 / 3.2</td> <td>∅ 4.1 / 4.2</td> </tr> </table> | U1N | U1N_MM | | | U2N | U2N_MM | | | U | U_MM | | | UNE | UNE_MAX | | | I1 | I1_MAX | | | I2 | I2_MAX | | | IN | IN_MAX | | | IPE | IPE_MAX | | | P | P1 | P_MAX / P1_MAX | For CU5000 divided into 2 images | Q | P2 | Q_MAX / P2_MAX | F | Q1 | S_MAX / Q1_MAX | PF | Q2 | F_MM / Q2_MAX | P_TRIANGLE | P1_TRIANGLE | P2_TRIANGLE | | PF_MIN | Cφ_MIN | | | > 1.1 / 1.2 | > 2.1 / 2.2 | > 3.1 / 3.2 | > 4.1 / 4.2 | ∅ 1.1 / 1.2 | ∅ 2.1 / 2.2 | ∅ 3.1 / 3.2 | ∅ 4.1 / 4.2 |
| U1N | U1N_MM | | | | | | | | | | | | | | | | | | | | | | | | | | | | | | | | | | | | | | | | | | | | | | | | | | | | | | | | | | | | | |
| U2N | U2N_MM | | | | | | | | | | | | | | | | | | | | | | | | | | | | | | | | | | | | | | | | | | | | | | | | | | | | | | | | | | | | | |
| U | U_MM | | | | | | | | | | | | | | | | | | | | | | | | | | | | | | | | | | | | | | | | | | | | | | | | | | | | | | | | | | | | | |
| UNE | UNE_MAX | | | | | | | | | | | | | | | | | | | | | | | | | | | | | | | | | | | | | | | | | | | | | | | | | | | | | | | | | | | | | |
| I1 | I1_MAX | | | | | | | | | | | | | | | | | | | | | | | | | | | | | | | | | | | | | | | | | | | | | | | | | | | | | | | | | | | | | |
| I2 | I2_MAX | | | | | | | | | | | | | | | | | | | | | | | | | | | | | | | | | | | | | | | | | | | | | | | | | | | | | | | | | | | | | |
| IN | IN_MAX | | | | | | | | | | | | | | | | | | | | | | | | | | | | | | | | | | | | | | | | | | | | | | | | | | | | | | | | | | | | | |
| IPE | IPE_MAX | | | | | | | | | | | | | | | | | | | | | | | | | | | | | | | | | | | | | | | | | | | | | | | | | | | | | | | | | | | | | |
| P | P1 | P_MAX / P1_MAX | For CU5000 divided into 2 images | | | | | | | | | | | | | | | | | | | | | | | | | | | | | | | | | | | | | | | | | | | | | | | | | | | | | | | | | | | |
| Q | P2 | Q_MAX / P2_MAX | | | | | | | | | | | | | | | | | | | | | | | | | | | | | | | | | | | | | | | | | | | | | | | | | | | | | | | | | | | | |
| F | Q1 | S_MAX / Q1_MAX | | | | | | | | | | | | | | | | | | | | | | | | | | | | | | | | | | | | | | | | | | | | | | | | | | | | | | | | | | | | |
| PF | Q2 | F_MM / Q2_MAX | | | | | | | | | | | | | | | | | | | | | | | | | | | | | | | | | | | | | | | | | | | | | | | | | | | | | | | | | | | | |
| P_TRIANGLE | P1_TRIANGLE | P2_TRIANGLE | | | | | | | | | | | | | | | | | | | | | | | | | | | | | | | | | | | | | | | | | | | | | | | | | | | | | | | | | | | | |
| PF_MIN | Cφ_MIN | | | | | | | | | | | | | | | | | | | | | | | | | | | | | | | | | | | | | | | | | | | | | | | | | | | | | | | | | | | | | |
| > 1.1 / 1.2 | > 2.1 / 2.2 | > 3.1 / 3.2 | > 4.1 / 4.2 | | | | | | | | | | | | | | | | | | | | | | | | | | | | | | | | | | | | | | | | | | | | | | | | | | | | | | | | | | | |
| ∅ 1.1 / 1.2 | ∅ 2.1 / 2.2 | ∅ 3.1 / 3.2 | ∅ 4.1 / 4.2 | | | | | | | | | | | | | | | | | | | | | | | | | | | | | | | | | | | | | | | | | | | | | | | | | | | | | | | | | | | |
|  Energy Meter contents Standard meters | <table border="1"> <tr> <td>ΣP_I_IV_HT</td> </tr> <tr> <td>ΣP_I_IV_NT</td> </tr> <tr> <td>ΣP_II_III_NT</td> </tr> <tr> <td>ΣP_II_III_HT</td> </tr> <tr> <td>ΣQ_I_II_HT</td> </tr> <tr> <td>ΣQ_I_II_NT</td> </tr> <tr> <td>ΣQ_III_IV_HT</td> </tr> <tr> <td>ΣQ_I_II_NT</td> </tr> </table> | ΣP_I_IV_HT | ΣP_I_IV_NT | ΣP_II_III_NT | ΣP_II_III_HT | ΣQ_I_II_HT | ΣQ_I_II_NT | ΣQ_III_IV_HT | ΣQ_I_II_NT | | | | | | | | | | | | | | | | | | | | | | | | | | | | | | | | | | | | | | | | | | | | | | | | | | | | | |
| ΣP_I_IV_HT | | | | | | | | | | | | | | | | | | | | | | | | | | | | | | | | | | | | | | | | | | | | | | | | | | | | | | | | | | | | | | |
| ΣP_I_IV_NT | | | | | | | | | | | | | | | | | | | | | | | | | | | | | | | | | | | | | | | | | | | | | | | | | | | | | | | | | | | | | | |
| ΣP_II_III_NT | | | | | | | | | | | | | | | | | | | | | | | | | | | | | | | | | | | | | | | | | | | | | | | | | | | | | | | | | | | | | | |
| ΣP_II_III_HT | | | | | | | | | | | | | | | | | | | | | | | | | | | | | | | | | | | | | | | | | | | | | | | | | | | | | | | | | | | | | | |
| ΣQ_I_II_HT | | | | | | | | | | | | | | | | | | | | | | | | | | | | | | | | | | | | | | | | | | | | | | | | | | | | | | | | | | | | | | |
| ΣQ_I_II_NT | | | | | | | | | | | | | | | | | | | | | | | | | | | | | | | | | | | | | | | | | | | | | | | | | | | | | | | | | | | | | | |
| ΣQ_III_IV_HT | | | | | | | | | | | | | | | | | | | | | | | | | | | | | | | | | | | | | | | | | | | | | | | | | | | | | | | | | | | | | | |
| ΣQ_I_II_NT | | | | | | | | | | | | | | | | | | | | | | | | | | | | | | | | | | | | | | | | | | | | | | | | | | | | | | | | | | | | | | |
|  Energy Meter contents User meters | <table border="1"> <tr> <td>ΣMETER1</td> </tr> <tr> <td>ΣMETER2</td> </tr> <tr> <td>ΣMETER3</td> </tr> <tr> <td>ΣMETER4</td> </tr> <tr> <td>ΣMETER5</td> </tr> <tr> <td>ΣMETER6</td> </tr> <tr> <td>ΣMETER7</td> </tr> <tr> <td>ΣMETER8</td> </tr> <tr> <td>ΣMETER9</td> </tr> <tr> <td>ΣMETER10</td> </tr> <tr> <td>ΣMETER11</td> </tr> <tr> <td>ΣMETER12</td> </tr> </table> | ΣMETER1 | ΣMETER2 | ΣMETER3 | ΣMETER4 | ΣMETER5 | ΣMETER6 | ΣMETER7 | ΣMETER8 | ΣMETER9 | ΣMETER10 | ΣMETER11 | ΣMETER12 | | | | | | | | | | | | | | | | | | | | | | | | | | | | | | | | | | | | | | | | | | | | | | | | | |
| ΣMETER1 | | | | | | | | | | | | | | | | | | | | | | | | | | | | | | | | | | | | | | | | | | | | | | | | | | | | | | | | | | | | | | |
| ΣMETER2 | | | | | | | | | | | | | | | | | | | | | | | | | | | | | | | | | | | | | | | | | | | | | | | | | | | | | | | | | | | | | | |
| ΣMETER3 | | | | | | | | | | | | | | | | | | | | | | | | | | | | | | | | | | | | | | | | | | | | | | | | | | | | | | | | | | | | | | |
| ΣMETER4 | | | | | | | | | | | | | | | | | | | | | | | | | | | | | | | | | | | | | | | | | | | | | | | | | | | | | | | | | | | | | | |
| ΣMETER5 | | | | | | | | | | | | | | | | | | | | | | | | | | | | | | | | | | | | | | | | | | | | | | | | | | | | | | | | | | | | | | |
| ΣMETER6 | | | | | | | | | | | | | | | | | | | | | | | | | | | | | | | | | | | | | | | | | | | | | | | | | | | | | | | | | | | | | | |
| ΣMETER7 | | | | | | | | | | | | | | | | | | | | | | | | | | | | | | | | | | | | | | | | | | | | | | | | | | | | | | | | | | | | | | |
| ΣMETER8 | | | | | | | | | | | | | | | | | | | | | | | | | | | | | | | | | | | | | | | | | | | | | | | | | | | | | | | | | | | | | | |
| ΣMETER9 | | | | | | | | | | | | | | | | | | | | | | | | | | | | | | | | | | | | | | | | | | | | | | | | | | | | | | | | | | | | | | |
| ΣMETER10 | | | | | | | | | | | | | | | | | | | | | | | | | | | | | | | | | | | | | | | | | | | | | | | | | | | | | | | | | | | | | | |
| ΣMETER11 | | | | | | | | | | | | | | | | | | | | | | | | | | | | | | | | | | | | | | | | | | | | | | | | | | | | | | | | | | | | | | |
| ΣMETER12 | | | | | | | | | | | | | | | | | | | | | | | | | | | | | | | | | | | | | | | | | | | | | | | | | | | | | | | | | | | | | | |
|  Energy Mean-values Power mean-values + trend | <table border="1"> <tr> <td>MT_P_I_IV</td> <td>MT_P_II_III</td> <td>MT_Q_I_II</td> <td>MT_Q_III_IV</td> <td>MT_S</td> </tr> </table> | MT_P_I_IV | MT_P_II_III | MT_Q_I_II | MT_Q_III_IV | MT_S | | | | | | | | | | | | | | | | | | | | | | | | | | | | | | | | | | | | | | | | | | | | | | | | | | | | | | | | |
| MT_P_I_IV | MT_P_II_III | MT_Q_I_II | MT_Q_III_IV | MT_S | | | | | | | | | | | | | | | | | | | | | | | | | | | | | | | | | | | | | | | | | | | | | | | | | | | | | | | | | | |
|  Energy Mean-values User mean-values + trend | <table border="1"> <tr> <td>M1 / TR_M1</td> <td>M1_MM</td> <td rowspan="12">For CU5000 divided into 2 images each</td> </tr> <tr> <td>M2 / TR_M2</td> <td>M2_MM</td> </tr> <tr> <td>M3 / TR_M3</td> <td>M3_MM</td> </tr> <tr> <td>M4 / TR_M4</td> <td>M4_MM</td> </tr> <tr> <td>M5 / TR_M5</td> <td>M5_MM</td> </tr> <tr> <td>M6 / TR_M6</td> <td>M6_MM</td> </tr> <tr> <td>M7 / TR_M7</td> <td>M7_MM</td> </tr> <tr> <td>M8 / TR_M8</td> <td>M8_MM</td> </tr> <tr> <td>M9 / TR_M9</td> <td>M9_MM</td> </tr> <tr> <td>M10 / TR_M10</td> <td>M10_MM</td> </tr> <tr> <td>M11 / TR_M11</td> <td>M11_MM</td> </tr> <tr> <td>M12 / TR_M12</td> <td>M12_MM</td> </tr> </table> | M1 / TR_M1 | M1_MM | For CU5000 divided into 2 images each | M2 / TR_M2 | M2_MM | M3 / TR_M3 | M3_MM | M4 / TR_M4 | M4_MM | M5 / TR_M5 | M5_MM | M6 / TR_M6 | M6_MM | M7 / TR_M7 | M7_MM | M8 / TR_M8 | M8_MM | M9 / TR_M9 | M9_MM | M10 / TR_M10 | M10_MM | M11 / TR_M11 | M11_MM | M12 / TR_M12 | M12_MM | | | | | | | | | | | | | | | | | | | | | | | | | | | | | | | | | | | | |
| M1 / TR_M1 | M1_MM | For CU5000 divided into 2 images each | | | | | | | | | | | | | | | | | | | | | | | | | | | | | | | | | | | | | | | | | | | | | | | | | | | | | | | | | | | | |
| M2 / TR_M2 | M2_MM | | | | | | | | | | | | | | | | | | | | | | | | | | | | | | | | | | | | | | | | | | | | | | | | | | | | | | | | | | | | | |
| M3 / TR_M3 | M3_MM | | | | | | | | | | | | | | | | | | | | | | | | | | | | | | | | | | | | | | | | | | | | | | | | | | | | | | | | | | | | | |
| M4 / TR_M4 | M4_MM | | | | | | | | | | | | | | | | | | | | | | | | | | | | | | | | | | | | | | | | | | | | | | | | | | | | | | | | | | | | | |
| M5 / TR_M5 | M5_MM | | | | | | | | | | | | | | | | | | | | | | | | | | | | | | | | | | | | | | | | | | | | | | | | | | | | | | | | | | | | | |
| M6 / TR_M6 | M6_MM | | | | | | | | | | | | | | | | | | | | | | | | | | | | | | | | | | | | | | | | | | | | | | | | | | | | | | | | | | | | | |
| M7 / TR_M7 | M7_MM | | | | | | | | | | | | | | | | | | | | | | | | | | | | | | | | | | | | | | | | | | | | | | | | | | | | | | | | | | | | | |
| M8 / TR_M8 | M8_MM | | | | | | | | | | | | | | | | | | | | | | | | | | | | | | | | | | | | | | | | | | | | | | | | | | | | | | | | | | | | | |
| M9 / TR_M9 | M9_MM | | | | | | | | | | | | | | | | | | | | | | | | | | | | | | | | | | | | | | | | | | | | | | | | | | | | | | | | | | | | | |
| M10 / TR_M10 | M10_MM | | | | | | | | | | | | | | | | | | | | | | | | | | | | | | | | | | | | | | | | | | | | | | | | | | | | | | | | | | | | | |
| M11 / TR_M11 | M11_MM | | | | | | | | | | | | | | | | | | | | | | | | | | | | | | | | | | | | | | | | | | | | | | | | | | | | | | | | | | | | | |
| M12 / TR_M12 | M12_MM | | | | | | | | | | | | | | | | | | | | | | | | | | | | | | | | | | | | | | | | | | | | | | | | | | | | | | | | | | | | | |
|  Energy Bimetal current | <table border="1"> <tr> <td>IB1</td> </tr> <tr> <td>IB2</td> </tr> <tr> <td>IB1_MAX</td> </tr> <tr> <td>IB2_MAX</td> </tr> </table> | IB1 | IB2 | IB1_MAX | IB2_MAX | | | | | | | | | | | | | | | | | | | | | | | | | | | | | | | | | | | | | | | | | | | | | | | | | | | | | | | | | |
| IB1 | | | | | | | | | | | | | | | | | | | | | | | | | | | | | | | | | | | | | | | | | | | | | | | | | | | | | | | | | | | | | | |
| IB2 | | | | | | | | | | | | | | | | | | | | | | | | | | | | | | | | | | | | | | | | | | | | | | | | | | | | | | | | | | | | | | |
| IB1_MAX | | | | | | | | | | | | | | | | | | | | | | | | | | | | | | | | | | | | | | | | | | | | | | | | | | | | | | | | | | | | | | |
| IB2_MAX | | | | | | | | | | | | | | | | | | | | | | | | | | | | | | | | | | | | | | | | | | | | | | | | | | | | | | | | | | | | | | |







B3 Display matrices for 3-wire system, balanced load

| Display menu | Corresponding matrix | | | | | | | | | | | | | | | | | | | | | | | | | | | | |
|--|---|---|-------------------------------------|---|--|----------------------------------|---|-------------------------------------|--|-------------------|-------------------------|--|--|------------|--|--|--|--------|--------|--|--|---------------|---------------|---------------|---------------|---------------|---------------|---------------|---------------|
|  Instantaneous values | <table border="1"> <tr> <td>U12 U23 U31 F</td> <td>UNE UNE_MAX ¹⁾</td> <td>U12_MM U23_MM U31_MM F_MM</td> <td>UR1 UR2 UR2R1 UR21_MAX</td> </tr> <tr> <td>I I_MAX IMS</td> <td colspan="3">¹⁾ Only if measurement of homopolar voltage has been activated</td> </tr> <tr> <td>P Q S PF</td> <td>P_MAX Q_MAX S_MAX</td> <td colspan="2"></td> </tr> <tr> <td>P_TRIANGLE</td> <td colspan="3"></td> </tr> <tr> <td>PF_MIN</td> <td>Cφ_MIN</td> <td colspan="2"></td> </tr> <tr> <td>I > 1.1 / 1.2</td> <td>I > 2.1 / 2.2</td> <td>I > 3.1 / 3.2</td> <td>I > 4.1 / 4.2</td> </tr> <tr> <td>I ≥ 1.1 / 1.2</td> <td>I ≥ 2.1 / 2.2</td> <td>I ≥ 3.1 / 3.2</td> <td>I ≥ 4.1 / 4.2</td> </tr> </table> | U12 U23 U31 F | UNE UNE_MAX ¹⁾ | U12_MM U23_MM U31_MM F_MM | UR1 UR2 UR2R1 UR21_MAX | I I_MAX IMS | ¹⁾ Only if measurement of homopolar voltage has been activated | | | P Q S PF | P_MAX Q_MAX S_MAX | | | P_TRIANGLE | | | | PF_MIN | Cφ_MIN | | | I > 1.1 / 1.2 | I > 2.1 / 2.2 | I > 3.1 / 3.2 | I > 4.1 / 4.2 | I ≥ 1.1 / 1.2 | I ≥ 2.1 / 2.2 | I ≥ 3.1 / 3.2 | I ≥ 4.1 / 4.2 |
| U12 U23 U31 F | UNE UNE_MAX ¹⁾ | U12_MM U23_MM U31_MM F_MM | UR1 UR2 UR2R1 UR21_MAX | | | | | | | | | | | | | | | | | | | | | | | | | | |
| I I_MAX IMS | ¹⁾ Only if measurement of homopolar voltage has been activated | | | | | | | | | | | | | | | | | | | | | | | | | | | | |
| P Q S PF | P_MAX Q_MAX S_MAX | | | | | | | | | | | | | | | | | | | | | | | | | | | | |
| P_TRIANGLE | | | | | | | | | | | | | | | | | | | | | | | | | | | | | |
| PF_MIN | Cφ_MIN | | | | | | | | | | | | | | | | | | | | | | | | | | | | |
| I > 1.1 / 1.2 | I > 2.1 / 2.2 | I > 3.1 / 3.2 | I > 4.1 / 4.2 | | | | | | | | | | | | | | | | | | | | | | | | | | |
| I ≥ 1.1 / 1.2 | I ≥ 2.1 / 2.2 | I ≥ 3.1 / 3.2 | I ≥ 4.1 / 4.2 | | | | | | | | | | | | | | | | | | | | | | | | | | |
|  Energy Meter contents Standard meters | <table border="1"> <tr> <td>ΣP_I_IV_HT ΣP_I_IV_NT ΣP_II_III_NT ΣP_II_III_HT ΣQ_I_II_HT ΣQ_I_II_NT ΣQ_III_IV_HT ΣQ_I_II_NT</td> </tr> </table> | ΣP_I_IV_HT ΣP_I_IV_NT ΣP_II_III_NT ΣP_II_III_HT ΣQ_I_II_HT ΣQ_I_II_NT ΣQ_III_IV_HT ΣQ_I_II_NT | | | | | | | | | | | | | | | | | | | | | | | | | | | |
| ΣP_I_IV_HT ΣP_I_IV_NT ΣP_II_III_NT ΣP_II_III_HT ΣQ_I_II_HT ΣQ_I_II_NT ΣQ_III_IV_HT ΣQ_I_II_NT | | | | | | | | | | | | | | | | | | | | | | | | | | | | | |
|  Energy Meter contents User meters | <table border="1"> <tr> <td>ΣMETER1 ΣMETER2 ΣMETER3 ΣMETER4 ΣMETER5 ΣMETER6 ΣMETER7 ΣMETER8 ΣMETER9 ΣMETER10 ΣMETER11 ΣMETER12</td> </tr> </table> | ΣMETER1 ΣMETER2 ΣMETER3 ΣMETER4 ΣMETER5 ΣMETER6 ΣMETER7 ΣMETER8 ΣMETER9 ΣMETER10 ΣMETER11 ΣMETER12 | | | | | | | | | | | | | | | | | | | | | | | | | | | |
| ΣMETER1 ΣMETER2 ΣMETER3 ΣMETER4 ΣMETER5 ΣMETER6 ΣMETER7 ΣMETER8 ΣMETER9 ΣMETER10 ΣMETER11 ΣMETER12 | | | | | | | | | | | | | | | | | | | | | | | | | | | | | |
|  Energy Mean-values Power mean-values + trend | <table border="1"> <tr> <td>MT_P_I_IV</td> <td>MT_P_II_III</td> <td>MT_Q_I_II</td> <td>MT_Q_III_IV</td> <td>MT_S</td> </tr> </table> | MT_P_I_IV | MT_P_II_III | MT_Q_I_II | MT_Q_III_IV | MT_S | | | | | | | | | | | | | | | | | | | | | | | |
| MT_P_I_IV | MT_P_II_III | MT_Q_I_II | MT_Q_III_IV | MT_S | | | | | | | | | | | | | | | | | | | | | | | | | |
|  Energy Mean-values User mean-values + trend | <table border="1"> <tr> <td>M1 / TR_M1 M2 / TR_M2 M3 / TR_M3 M4 / TR_M4</td> <td>M1_MM M2_MM M3_MM M4_MM</td> <td rowspan="12">For CU5000 divided into 2 images each</td> </tr> <tr> <td>M5 / TR_M5 M6 / TR_M6 M7 / TR_M7 M8 / TR_M8</td> <td>M5_MM M6_MM M7_MM M8_MM</td> </tr> <tr> <td>M9 / TR_M9 M10 / TR_M10 M11 / TR_M11 M12 / TR_M12</td> <td>M9_MM M10_MM M11_MM M12_MM</td> </tr> </table> | M1 / TR_M1 M2 / TR_M2 M3 / TR_M3 M4 / TR_M4 | M1_MM M2_MM M3_MM M4_MM | For CU5000 divided into 2 images each | M5 / TR_M5 M6 / TR_M6 M7 / TR_M7 M8 / TR_M8 | M5_MM M6_MM M7_MM M8_MM | M9 / TR_M9 M10 / TR_M10 M11 / TR_M11 M12 / TR_M12 | M9_MM M10_MM M11_MM M12_MM | | | | | | | | | | | | | | | | | | | | | |
| M1 / TR_M1 M2 / TR_M2 M3 / TR_M3 M4 / TR_M4 | M1_MM M2_MM M3_MM M4_MM | For CU5000 divided into 2 images each | | | | | | | | | | | | | | | | | | | | | | | | | | | |
| M5 / TR_M5 M6 / TR_M6 M7 / TR_M7 M8 / TR_M8 | M5_MM M6_MM M7_MM M8_MM | | | | | | | | | | | | | | | | | | | | | | | | | | | | |
| M9 / TR_M9 M10 / TR_M10 M11 / TR_M11 M12 / TR_M12 | M9_MM M10_MM M11_MM M12_MM | | | | | | | | | | | | | | | | | | | | | | | | | | | | |
|  Energy Bimetal current | <table border="1"> <tr> <td>IB IB_MAX</td> </tr> </table> | | IB IB_MAX | | | | | | | | | | | | | | | | | | | | | | | | | | |
| IB IB_MAX | | | | | | | | | | | | | | | | | | | | | | | | | | | | | |







B4 Display matrices for 3-wire system, balanced load, phase shift

| Display menu | Corresponding matrix | | | | | | | | | | | | | | | | | | | | | | | | | | | | | | | | | | | | | | | | | | | | | | | | |
|--|---|-------------|-------------|--------------|--------------|------------|------------|--------------|------------|------------|----------|------------|----------|------------|-------|------------|-------|------------|-------|--------------|--------|--------------|--------|--------------|--------|---|-------|--|--|----|--|--|--|------------|--|--|--|--------|--------|--|--|-------------|-------------|-------------|-------------|-------------|-------------|-------------|-------------|
|  Instantaneous values | <table border="1"> <tr> <td>U</td> <td>U_MM</td> <td></td> <td></td> </tr> <tr> <td>I</td> <td>I_MAX</td> <td></td> <td></td> </tr> <tr> <td>P</td> <td>P_MAX</td> <td></td> <td></td> </tr> <tr> <td>F</td> <td>F_MM</td> <td></td> <td></td> </tr> <tr> <td>P</td> <td>P_MAX</td> <td></td> <td></td> </tr> <tr> <td>Q</td> <td>Q_MAX</td> <td></td> <td></td> </tr> <tr> <td>S</td> <td>S_MAX</td> <td></td> <td></td> </tr> <tr> <td>PF</td> <td></td> <td></td> <td></td> </tr> <tr> <td>P_TRIANGLE</td> <td></td> <td></td> <td></td> </tr> <tr> <td>PF_MIN</td> <td>Cφ_MIN</td> <td></td> <td></td> </tr> <tr> <td> > 1.1 / 1.2</td> <td> > 2.1 / 2.2</td> <td> > 3.1 / 3.2</td> <td> > 4.1 / 4.2</td> </tr> <tr> <td>∅ 1.1 / 1.2</td> <td>∅ 2.1 / 2.2</td> <td>∅ 3.1 / 3.2</td> <td>∅ 4.1 / 4.2</td> </tr> </table> | U | U_MM | | | I | I_MAX | | | P | P_MAX | | | F | F_MM | | | P | P_MAX | | | Q | Q_MAX | | | S | S_MAX | | | PF | | | | P_TRIANGLE | | | | PF_MIN | Cφ_MIN | | | > 1.1 / 1.2 | > 2.1 / 2.2 | > 3.1 / 3.2 | > 4.1 / 4.2 | ∅ 1.1 / 1.2 | ∅ 2.1 / 2.2 | ∅ 3.1 / 3.2 | ∅ 4.1 / 4.2 |
| U | U_MM | | | | | | | | | | | | | | | | | | | | | | | | | | | | | | | | | | | | | | | | | | | | | | | | |
| I | I_MAX | | | | | | | | | | | | | | | | | | | | | | | | | | | | | | | | | | | | | | | | | | | | | | | | |
| P | P_MAX | | | | | | | | | | | | | | | | | | | | | | | | | | | | | | | | | | | | | | | | | | | | | | | | |
| F | F_MM | | | | | | | | | | | | | | | | | | | | | | | | | | | | | | | | | | | | | | | | | | | | | | | | |
| P | P_MAX | | | | | | | | | | | | | | | | | | | | | | | | | | | | | | | | | | | | | | | | | | | | | | | | |
| Q | Q_MAX | | | | | | | | | | | | | | | | | | | | | | | | | | | | | | | | | | | | | | | | | | | | | | | | |
| S | S_MAX | | | | | | | | | | | | | | | | | | | | | | | | | | | | | | | | | | | | | | | | | | | | | | | | |
| PF | | | | | | | | | | | | | | | | | | | | | | | | | | | | | | | | | | | | | | | | | | | | | | | | | |
| P_TRIANGLE | | | | | | | | | | | | | | | | | | | | | | | | | | | | | | | | | | | | | | | | | | | | | | | | | |
| PF_MIN | Cφ_MIN | | | | | | | | | | | | | | | | | | | | | | | | | | | | | | | | | | | | | | | | | | | | | | | | |
| > 1.1 / 1.2 | > 2.1 / 2.2 | > 3.1 / 3.2 | > 4.1 / 4.2 | | | | | | | | | | | | | | | | | | | | | | | | | | | | | | | | | | | | | | | | | | | | | | |
| ∅ 1.1 / 1.2 | ∅ 2.1 / 2.2 | ∅ 3.1 / 3.2 | ∅ 4.1 / 4.2 | | | | | | | | | | | | | | | | | | | | | | | | | | | | | | | | | | | | | | | | | | | | | | |
|  Energy Meter contents Standard meters | <table border="1"> <tr> <td>ΣP_I_IV_HT</td> </tr> <tr> <td>ΣP_I_IV_NT</td> </tr> <tr> <td>ΣP_II_III_NT</td> </tr> <tr> <td>ΣP_II_III_HT</td> </tr> <tr> <td>ΣQ_I_II_HT</td> </tr> <tr> <td>ΣQ_I_II_NT</td> </tr> <tr> <td>ΣQ_III_IV_HT</td> </tr> <tr> <td>ΣQ_I_II_NT</td> </tr> </table> | ΣP_I_IV_HT | ΣP_I_IV_NT | ΣP_II_III_NT | ΣP_II_III_HT | ΣQ_I_II_HT | ΣQ_I_II_NT | ΣQ_III_IV_HT | ΣQ_I_II_NT | | | | | | | | | | | | | | | | | | | | | | | | | | | | | | | | | | | | | | | | |
| ΣP_I_IV_HT | | | | | | | | | | | | | | | | | | | | | | | | | | | | | | | | | | | | | | | | | | | | | | | | | |
| ΣP_I_IV_NT | | | | | | | | | | | | | | | | | | | | | | | | | | | | | | | | | | | | | | | | | | | | | | | | | |
| ΣP_II_III_NT | | | | | | | | | | | | | | | | | | | | | | | | | | | | | | | | | | | | | | | | | | | | | | | | | |
| ΣP_II_III_HT | | | | | | | | | | | | | | | | | | | | | | | | | | | | | | | | | | | | | | | | | | | | | | | | | |
| ΣQ_I_II_HT | | | | | | | | | | | | | | | | | | | | | | | | | | | | | | | | | | | | | | | | | | | | | | | | | |
| ΣQ_I_II_NT | | | | | | | | | | | | | | | | | | | | | | | | | | | | | | | | | | | | | | | | | | | | | | | | | |
| ΣQ_III_IV_HT | | | | | | | | | | | | | | | | | | | | | | | | | | | | | | | | | | | | | | | | | | | | | | | | | |
| ΣQ_I_II_NT | | | | | | | | | | | | | | | | | | | | | | | | | | | | | | | | | | | | | | | | | | | | | | | | | |
|  Energy Meter contents User meters | <table border="1"> <tr> <td>ΣMETER1</td> </tr> <tr> <td>ΣMETER2</td> </tr> <tr> <td>ΣMETER3</td> </tr> <tr> <td>ΣMETER4</td> </tr> <tr> <td>ΣMETER5</td> </tr> <tr> <td>ΣMETER6</td> </tr> <tr> <td>ΣMETER7</td> </tr> <tr> <td>ΣMETER8</td> </tr> <tr> <td>ΣMETER9</td> </tr> <tr> <td>ΣMETER10</td> </tr> <tr> <td>ΣMETER11</td> </tr> <tr> <td>ΣMETER12</td> </tr> </table> | ΣMETER1 | ΣMETER2 | ΣMETER3 | ΣMETER4 | ΣMETER5 | ΣMETER6 | ΣMETER7 | ΣMETER8 | ΣMETER9 | ΣMETER10 | ΣMETER11 | ΣMETER12 | | | | | | | | | | | | | | | | | | | | | | | | | | | | | | | | | | | | |
| ΣMETER1 | | | | | | | | | | | | | | | | | | | | | | | | | | | | | | | | | | | | | | | | | | | | | | | | | |
| ΣMETER2 | | | | | | | | | | | | | | | | | | | | | | | | | | | | | | | | | | | | | | | | | | | | | | | | | |
| ΣMETER3 | | | | | | | | | | | | | | | | | | | | | | | | | | | | | | | | | | | | | | | | | | | | | | | | | |
| ΣMETER4 | | | | | | | | | | | | | | | | | | | | | | | | | | | | | | | | | | | | | | | | | | | | | | | | | |
| ΣMETER5 | | | | | | | | | | | | | | | | | | | | | | | | | | | | | | | | | | | | | | | | | | | | | | | | | |
| ΣMETER6 | | | | | | | | | | | | | | | | | | | | | | | | | | | | | | | | | | | | | | | | | | | | | | | | | |
| ΣMETER7 | | | | | | | | | | | | | | | | | | | | | | | | | | | | | | | | | | | | | | | | | | | | | | | | | |
| ΣMETER8 | | | | | | | | | | | | | | | | | | | | | | | | | | | | | | | | | | | | | | | | | | | | | | | | | |
| ΣMETER9 | | | | | | | | | | | | | | | | | | | | | | | | | | | | | | | | | | | | | | | | | | | | | | | | | |
| ΣMETER10 | | | | | | | | | | | | | | | | | | | | | | | | | | | | | | | | | | | | | | | | | | | | | | | | | |
| ΣMETER11 | | | | | | | | | | | | | | | | | | | | | | | | | | | | | | | | | | | | | | | | | | | | | | | | | |
| ΣMETER12 | | | | | | | | | | | | | | | | | | | | | | | | | | | | | | | | | | | | | | | | | | | | | | | | | |
|  Energy Mean-values Power mean-values + trend | <table border="1"> <tr> <td>MT_P_I_IV</td> <td>MT_P_II_III</td> <td>MT_Q_I_II</td> <td>MT_Q_III_IV</td> <td>MT_S</td> </tr> </table> | MT_P_I_IV | MT_P_II_III | MT_Q_I_II | MT_Q_III_IV | MT_S | | | | | | | | | | | | | | | | | | | | | | | | | | | | | | | | | | | | | | | | | | | |
| MT_P_I_IV | MT_P_II_III | MT_Q_I_II | MT_Q_III_IV | MT_S | | | | | | | | | | | | | | | | | | | | | | | | | | | | | | | | | | | | | | | | | | | | | |
|  Energy Mean-values User mean-values + trend | <table border="1"> <tr> <td>M1 / TR_M1</td> <td>M1_MM</td> </tr> <tr> <td>M2 / TR_M2</td> <td>M2_MM</td> </tr> <tr> <td>M3 / TR_M3</td> <td>M3_MM</td> </tr> <tr> <td>M4 / TR_M4</td> <td>M4_MM</td> </tr> <tr> <td>M5 / TR_M5</td> <td>M5_MM</td> </tr> <tr> <td>M6 / TR_M6</td> <td>M6_MM</td> </tr> <tr> <td>M7 / TR_M7</td> <td>M7_MM</td> </tr> <tr> <td>M8 / TR_M8</td> <td>M8_MM</td> </tr> <tr> <td>M9 / TR_M9</td> <td>M9_MM</td> </tr> <tr> <td>M10 / TR_M10</td> <td>M10_MM</td> </tr> <tr> <td>M11 / TR_M11</td> <td>M11_MM</td> </tr> <tr> <td>M12 / TR_M12</td> <td>M12_MM</td> </tr> </table> <p>For CU5000 divided into 2 images each</p> | M1 / TR_M1 | M1_MM | M2 / TR_M2 | M2_MM | M3 / TR_M3 | M3_MM | M4 / TR_M4 | M4_MM | M5 / TR_M5 | M5_MM | M6 / TR_M6 | M6_MM | M7 / TR_M7 | M7_MM | M8 / TR_M8 | M8_MM | M9 / TR_M9 | M9_MM | M10 / TR_M10 | M10_MM | M11 / TR_M11 | M11_MM | M12 / TR_M12 | M12_MM | | | | | | | | | | | | | | | | | | | | | | | | |
| M1 / TR_M1 | M1_MM | | | | | | | | | | | | | | | | | | | | | | | | | | | | | | | | | | | | | | | | | | | | | | | | |
| M2 / TR_M2 | M2_MM | | | | | | | | | | | | | | | | | | | | | | | | | | | | | | | | | | | | | | | | | | | | | | | | |
| M3 / TR_M3 | M3_MM | | | | | | | | | | | | | | | | | | | | | | | | | | | | | | | | | | | | | | | | | | | | | | | | |
| M4 / TR_M4 | M4_MM | | | | | | | | | | | | | | | | | | | | | | | | | | | | | | | | | | | | | | | | | | | | | | | | |
| M5 / TR_M5 | M5_MM | | | | | | | | | | | | | | | | | | | | | | | | | | | | | | | | | | | | | | | | | | | | | | | | |
| M6 / TR_M6 | M6_MM | | | | | | | | | | | | | | | | | | | | | | | | | | | | | | | | | | | | | | | | | | | | | | | | |
| M7 / TR_M7 | M7_MM | | | | | | | | | | | | | | | | | | | | | | | | | | | | | | | | | | | | | | | | | | | | | | | | |
| M8 / TR_M8 | M8_MM | | | | | | | | | | | | | | | | | | | | | | | | | | | | | | | | | | | | | | | | | | | | | | | | |
| M9 / TR_M9 | M9_MM | | | | | | | | | | | | | | | | | | | | | | | | | | | | | | | | | | | | | | | | | | | | | | | | |
| M10 / TR_M10 | M10_MM | | | | | | | | | | | | | | | | | | | | | | | | | | | | | | | | | | | | | | | | | | | | | | | | |
| M11 / TR_M11 | M11_MM | | | | | | | | | | | | | | | | | | | | | | | | | | | | | | | | | | | | | | | | | | | | | | | | |
| M12 / TR_M12 | M12_MM | | | | | | | | | | | | | | | | | | | | | | | | | | | | | | | | | | | | | | | | | | | | | | | | |
|  Energy Bimetal current | <table border="1"> <tr> <td>IB</td> </tr> <tr> <td>IB_MAX</td> </tr> </table> | IB | IB_MAX | | | | | | | | | | | | | | | | | | | | | | | | | | | | | | | | | | | | | | | | | | | | | | |
| IB | | | | | | | | | | | | | | | | | | | | | | | | | | | | | | | | | | | | | | | | | | | | | | | | | |
| IB_MAX | | | | | | | | | | | | | | | | | | | | | | | | | | | | | | | | | | | | | | | | | | | | | | | | | |







B5 Display matrices for 3-wire systems, unbalanced load

| Display menu | Corresponding matrix | | | | | | | | | | | | | | | | | | | | | | | | |
|--|--|---|---------------------------------|------------------------------------|---------------------------------|-----------------------|---------------------------------------|---------------------------------|-------|---------------------------------|-------------------------|--|-------|------------|--------|------------|-------|---------------|---------------|---------------|---------------|---------------|---------------|---------------|---------------|
|  Instantaneous values | <table border="1"> <tr> <td>U12 U23 U31 F</td> <td>UNE UNE_MAX 1)</td> <td>U12_MM U23_MM U31_MM F_MM</td> <td>UR1 UR2 UR2R1 UR21_MAX</td> </tr> <tr> <td>I1 I2 I3 IPE</td> <td>I1_MAX I2_MAX I3_MAX IPE_MAX</td> <td>IR1 IR2 IR2R1 IR21_MAX</td> <td></td> </tr> <tr> <td>P Q S PF P_TRIANGLE</td> <td>P_MAX Q_MAX S_MAX</td> <td colspan="2">1) Only if measurement of homopolar voltage has been activated</td> </tr> <tr> <td>PF_MIN</td> <td>Cφ_MIN</td> <td></td> <td></td> </tr> <tr> <td>I > 1.1 / 1.2</td> <td>I > 2.1 / 2.2</td> <td>I > 3.1 / 3.2</td> <td>I > 4.1 / 4.2</td> </tr> <tr> <td>I ≥ 1.1 / 1.2</td> <td>I ≥ 2.1 / 2.2</td> <td>I ≥ 3.1 / 3.2</td> <td>I ≥ 4.1 / 4.2</td> </tr> </table> | U12 U23 U31 F | UNE UNE_MAX 1) | U12_MM U23_MM U31_MM F_MM | UR1 UR2 UR2R1 UR21_MAX | I1 I2 I3 IPE | I1_MAX I2_MAX I3_MAX IPE_MAX | IR1 IR2 IR2R1 IR21_MAX | | P Q S PF P_TRIANGLE | P_MAX Q_MAX S_MAX | 1) Only if measurement of homopolar voltage has been activated | | PF_MIN | Cφ_MIN | | | I > 1.1 / 1.2 | I > 2.1 / 2.2 | I > 3.1 / 3.2 | I > 4.1 / 4.2 | I ≥ 1.1 / 1.2 | I ≥ 2.1 / 2.2 | I ≥ 3.1 / 3.2 | I ≥ 4.1 / 4.2 |
| U12 U23 U31 F | UNE UNE_MAX 1) | U12_MM U23_MM U31_MM F_MM | UR1 UR2 UR2R1 UR21_MAX | | | | | | | | | | | | | | | | | | | | | | |
| I1 I2 I3 IPE | I1_MAX I2_MAX I3_MAX IPE_MAX | IR1 IR2 IR2R1 IR21_MAX | | | | | | | | | | | | | | | | | | | | | | | |
| P Q S PF P_TRIANGLE | P_MAX Q_MAX S_MAX | 1) Only if measurement of homopolar voltage has been activated | | | | | | | | | | | | | | | | | | | | | | | |
| PF_MIN | Cφ_MIN | | | | | | | | | | | | | | | | | | | | | | | | |
| I > 1.1 / 1.2 | I > 2.1 / 2.2 | I > 3.1 / 3.2 | I > 4.1 / 4.2 | | | | | | | | | | | | | | | | | | | | | | |
| I ≥ 1.1 / 1.2 | I ≥ 2.1 / 2.2 | I ≥ 3.1 / 3.2 | I ≥ 4.1 / 4.2 | | | | | | | | | | | | | | | | | | | | | | |
|  Energy Meter contents Standard meters | <table border="1"> <tr> <td> ΣP_I_IV_HT ΣP_I_IV_NT ΣP_II_III_NT ΣP_II_III_HT ΣQ_I_II_HT ΣQ_I_II_NT ΣQ_III_IV_HT ΣQ_I_II_NT </td> </tr> </table> | ΣP_I_IV_HT ΣP_I_IV_NT ΣP_II_III_NT ΣP_II_III_HT ΣQ_I_II_HT ΣQ_I_II_NT ΣQ_III_IV_HT ΣQ_I_II_NT | | | | | | | | | | | | | | | | | | | | | | | |
| ΣP_I_IV_HT ΣP_I_IV_NT ΣP_II_III_NT ΣP_II_III_HT ΣQ_I_II_HT ΣQ_I_II_NT ΣQ_III_IV_HT ΣQ_I_II_NT | | | | | | | | | | | | | | | | | | | | | | | | | |
|  Energy Meter contents User meters | <table border="1"> <tr> <td> ΣMETER1 ΣMETER2 ΣMETER3 ΣMETER4 ΣMETER5 ΣMETER6 ΣMETER7 ΣMETER8 ΣMETER9 ΣMETER10 ΣMETER11 ΣMETER12 </td> </tr> </table> | ΣMETER1 ΣMETER2 ΣMETER3 ΣMETER4 ΣMETER5 ΣMETER6 ΣMETER7 ΣMETER8 ΣMETER9 ΣMETER10 ΣMETER11 ΣMETER12 | | | | | | | | | | | | | | | | | | | | | | | |
| ΣMETER1 ΣMETER2 ΣMETER3 ΣMETER4 ΣMETER5 ΣMETER6 ΣMETER7 ΣMETER8 ΣMETER9 ΣMETER10 ΣMETER11 ΣMETER12 | | | | | | | | | | | | | | | | | | | | | | | | | |
|  Energy Mean-values Power mean-values + trend | <table border="1"> <tr> <td>MT_P_I_IV</td> <td>MT_P_II_III</td> <td>MT_Q_I_II</td> <td>MT_Q_III_IV</td> <td>MT_S</td> </tr> </table> | MT_P_I_IV | MT_P_II_III | MT_Q_I_II | MT_Q_III_IV | MT_S | | | | | | | | | | | | | | | | | | | |
| MT_P_I_IV | MT_P_II_III | MT_Q_I_II | MT_Q_III_IV | MT_S | | | | | | | | | | | | | | | | | | | | | |
|  Energy Mean-values User mean-values + trend | <table border="1"> <tr> <td>M1 / TR_M1</td> <td>M1_MM</td> </tr> <tr> <td>M2 / TR_M2</td> <td>M2_MM</td> </tr> <tr> <td>M3 / TR_M3</td> <td>M3_MM</td> </tr> <tr> <td>M4 / TR_M4</td> <td>M4_MM</td> </tr> <tr> <td>M5 / TR_M5</td> <td>M5_MM</td> </tr> <tr> <td>M6 / TR_M6</td> <td>M6_MM</td> </tr> <tr> <td>M7 / TR_M7</td> <td>M7_MM</td> </tr> <tr> <td>M8 / TR_M8</td> <td>M8_MM</td> </tr> <tr> <td>M9 / TR_M9</td> <td>M9_MM</td> </tr> <tr> <td>M10 / TR_M10</td> <td>M10_MM</td> </tr> <tr> <td>M11 / TR_M11</td> <td>M11_MM</td> </tr> <tr> <td>M12 / TR_M12</td> <td>M12_MM</td> </tr> </table> <p>For CU5000 divided into 2 images each</p> | M1 / TR_M1 | M1_MM | M2 / TR_M2 | M2_MM | M3 / TR_M3 | M3_MM | M4 / TR_M4 | M4_MM | M5 / TR_M5 | M5_MM | M6 / TR_M6 | M6_MM | M7 / TR_M7 | M7_MM | M8 / TR_M8 | M8_MM | M9 / TR_M9 | M9_MM | M10 / TR_M10 | M10_MM | M11 / TR_M11 | M11_MM | M12 / TR_M12 | M12_MM |
| M1 / TR_M1 | M1_MM | | | | | | | | | | | | | | | | | | | | | | | | |
| M2 / TR_M2 | M2_MM | | | | | | | | | | | | | | | | | | | | | | | | |
| M3 / TR_M3 | M3_MM | | | | | | | | | | | | | | | | | | | | | | | | |
| M4 / TR_M4 | M4_MM | | | | | | | | | | | | | | | | | | | | | | | | |
| M5 / TR_M5 | M5_MM | | | | | | | | | | | | | | | | | | | | | | | | |
| M6 / TR_M6 | M6_MM | | | | | | | | | | | | | | | | | | | | | | | | |
| M7 / TR_M7 | M7_MM | | | | | | | | | | | | | | | | | | | | | | | | |
| M8 / TR_M8 | M8_MM | | | | | | | | | | | | | | | | | | | | | | | | |
| M9 / TR_M9 | M9_MM | | | | | | | | | | | | | | | | | | | | | | | | |
| M10 / TR_M10 | M10_MM | | | | | | | | | | | | | | | | | | | | | | | | |
| M11 / TR_M11 | M11_MM | | | | | | | | | | | | | | | | | | | | | | | | |
| M12 / TR_M12 | M12_MM | | | | | | | | | | | | | | | | | | | | | | | | |
|  Energy Bimetal current | <table border="1"> <tr> <td>IB1 IB2 IB3</td> <td>IB1_MAX IB2_MAX IB3_MAX</td> </tr> </table> | IB1 IB2 IB3 | IB1_MAX IB2_MAX IB3_MAX | | | | | | | | | | | | | | | | | | | | | | |
| IB1 IB2 IB3 | IB1_MAX IB2_MAX IB3_MAX | | | | | | | | | | | | | | | | | | | | | | | | |







B6 Display matrices for 3-wire systems, unbalanced load, Aron

| Display menu | Corresponding matrix | | | | | | | | | | | | | | | | | | | | | | | | |
|--|--|---|----------------------------------|---------------------------------------|--|----------------------------------|--|--|--|-------------------|-------------------------|------------|--|--------|--------|--|--|-------------|-------------|-------------|-------------|-------------|-------------|-------------|-------------|
|  Instantaneous values | <table border="1"> <tr> <td>U12 U23 U31 F</td> <td>UNE UNE_MAX 1)</td> <td>U12_MM U23_MM U31_MM F_MM</td> <td>UR1 UR2 UR2R1 UR21_MAX</td> </tr> <tr> <td>I1 I2 I3 IMS</td> <td>I1_MAX I2_MAX I3_MAX</td> <td colspan="2" rowspan="3">1) Only if measurement of homopolar voltage has been activated</td> </tr> <tr> <td>P Q S PF</td> <td>P_MAX Q_MAX S_MAX</td> </tr> <tr> <td>P_TRIANGLE</td> <td></td> </tr> <tr> <td>PF_MIN</td> <td>Cφ_MIN</td> <td></td> <td></td> </tr> <tr> <td> > 1.1 / 1.2</td> <td> > 2.1 / 2.2</td> <td> > 3.1 / 3.2</td> <td> > 4.1 / 4.2</td> </tr> <tr> <td>∅ 1.1 / 1.2</td> <td>∅ 2.1 / 2.2</td> <td>∅ 3.1 / 3.2</td> <td>∅ 4.1 / 4.2</td> </tr> </table> | U12 U23 U31 F | UNE UNE_MAX 1) | U12_MM U23_MM U31_MM F_MM | UR1 UR2 UR2R1 UR21_MAX | I1 I2 I3 IMS | I1_MAX I2_MAX I3_MAX | 1) Only if measurement of homopolar voltage has been activated | | P Q S PF | P_MAX Q_MAX S_MAX | P_TRIANGLE | | PF_MIN | Cφ_MIN | | | > 1.1 / 1.2 | > 2.1 / 2.2 | > 3.1 / 3.2 | > 4.1 / 4.2 | ∅ 1.1 / 1.2 | ∅ 2.1 / 2.2 | ∅ 3.1 / 3.2 | ∅ 4.1 / 4.2 |
| U12 U23 U31 F | UNE UNE_MAX 1) | U12_MM U23_MM U31_MM F_MM | UR1 UR2 UR2R1 UR21_MAX | | | | | | | | | | | | | | | | | | | | | | |
| I1 I2 I3 IMS | I1_MAX I2_MAX I3_MAX | 1) Only if measurement of homopolar voltage has been activated | | | | | | | | | | | | | | | | | | | | | | | |
| P Q S PF | P_MAX Q_MAX S_MAX | | | | | | | | | | | | | | | | | | | | | | | | |
| P_TRIANGLE | | | | | | | | | | | | | | | | | | | | | | | | | |
| PF_MIN | Cφ_MIN | | | | | | | | | | | | | | | | | | | | | | | | |
| > 1.1 / 1.2 | > 2.1 / 2.2 | > 3.1 / 3.2 | > 4.1 / 4.2 | | | | | | | | | | | | | | | | | | | | | | |
| ∅ 1.1 / 1.2 | ∅ 2.1 / 2.2 | ∅ 3.1 / 3.2 | ∅ 4.1 / 4.2 | | | | | | | | | | | | | | | | | | | | | | |
|  Energy Meter contents Standard meters | <table border="1"> <tr> <td> ΣP_I_IV_HT ΣP_I_IV_NT ΣP_II_III_NT ΣP_II_III_HT ΣQ_I_II_HT ΣQ_I_II_NT ΣQ_III_IV_HT ΣQ_I_II_NT </td> </tr> </table> | ΣP_I_IV_HT ΣP_I_IV_NT ΣP_II_III_NT ΣP_II_III_HT ΣQ_I_II_HT ΣQ_I_II_NT ΣQ_III_IV_HT ΣQ_I_II_NT | | | | | | | | | | | | | | | | | | | | | | | |
| ΣP_I_IV_HT ΣP_I_IV_NT ΣP_II_III_NT ΣP_II_III_HT ΣQ_I_II_HT ΣQ_I_II_NT ΣQ_III_IV_HT ΣQ_I_II_NT | | | | | | | | | | | | | | | | | | | | | | | | | |
|  Energy Meter contents User meters | <table border="1"> <tr> <td> ΣMETER1 ΣMETER2 ΣMETER3 ΣMETER4 ΣMETER5 ΣMETER6 ΣMETER7 ΣMETER8 ΣMETER9 ΣMETER10 ΣMETER11 ΣMETER12 </td> </tr> </table> | ΣMETER1 ΣMETER2 ΣMETER3 ΣMETER4 ΣMETER5 ΣMETER6 ΣMETER7 ΣMETER8 ΣMETER9 ΣMETER10 ΣMETER11 ΣMETER12 | | | | | | | | | | | | | | | | | | | | | | | |
| ΣMETER1 ΣMETER2 ΣMETER3 ΣMETER4 ΣMETER5 ΣMETER6 ΣMETER7 ΣMETER8 ΣMETER9 ΣMETER10 ΣMETER11 ΣMETER12 | | | | | | | | | | | | | | | | | | | | | | | | | |
|  Energy Mean-values Power mean-values + trend | <table border="1"> <tr> <td>MT_P_I_IV</td> <td>MT_P_II_III</td> <td>MT_Q_I_II</td> <td>MT_Q_III_IV</td> <td>MT_S</td> </tr> </table> | MT_P_I_IV | MT_P_II_III | MT_Q_I_II | MT_Q_III_IV | MT_S | | | | | | | | | | | | | | | | | | | |
| MT_P_I_IV | MT_P_II_III | MT_Q_I_II | MT_Q_III_IV | MT_S | | | | | | | | | | | | | | | | | | | | | |
|  Energy Mean-values User mean-values + trend | <table border="1"> <tr> <td>M1 / TR_M1 M2 / TR_M2 M3 / TR_M3 M4 / TR_M4</td> <td>M1_MM M2_MM M3_MM M4_MM</td> <td rowspan="12">For CU5000 divided into 2 images each</td> </tr> <tr> <td>M5 / TR_M5 M6 / TR_M6 M7 / TR_M7 M8 / TR_M8</td> <td>M5_MM M6_MM M7_MM M8_MM</td> </tr> <tr> <td>M9 / TR_M9 M10 / TR_M10 M11 / TR_M11 M12 / TR_M12</td> <td>M9_MM M10_MM M11_MM M12_MM</td> </tr> </table> | M1 / TR_M1 M2 / TR_M2 M3 / TR_M3 M4 / TR_M4 | M1_MM M2_MM M3_MM M4_MM | For CU5000 divided into 2 images each | M5 / TR_M5 M6 / TR_M6 M7 / TR_M7 M8 / TR_M8 | M5_MM M6_MM M7_MM M8_MM | M9 / TR_M9 M10 / TR_M10 M11 / TR_M11 M12 / TR_M12 | M9_MM M10_MM M11_MM M12_MM | | | | | | | | | | | | | | | | | |
| M1 / TR_M1 M2 / TR_M2 M3 / TR_M3 M4 / TR_M4 | M1_MM M2_MM M3_MM M4_MM | For CU5000 divided into 2 images each | | | | | | | | | | | | | | | | | | | | | | | |
| M5 / TR_M5 M6 / TR_M6 M7 / TR_M7 M8 / TR_M8 | M5_MM M6_MM M7_MM M8_MM | | | | | | | | | | | | | | | | | | | | | | | | |
| M9 / TR_M9 M10 / TR_M10 M11 / TR_M11 M12 / TR_M12 | M9_MM M10_MM M11_MM M12_MM | | | | | | | | | | | | | | | | | | | | | | | | |
|  Energy Bimetal current | <table border="1"> <tr> <td>IB1 IB2 IB3</td> <td>IB1_MAX IB2_MAX IB3_MAX</td> </tr> </table> | | IB1 IB2 IB3 | | IB1_MAX IB2_MAX IB3_MAX | | | | | | | | | | | | | | | | | | | | |
| IB1 IB2 IB3 | IB1_MAX IB2_MAX IB3_MAX | | | | | | | | | | | | | | | | | | | | | | | | |







B7 Display matrices for 4-wire system, balanced load

| Display menu | Corresponding matrix | | | | | | | | | | | | | | | | | | | | | | | | | | | | | | | | | | | | | | | | | | | | | | | | |
|--|---|---|--------------|---|--------------|------------|------------|--------------|------------|---------|------------|----------|------------|-------|------------|-------|------------|-------|------------|-------|--------------|--------|--------------|--------|--------------|--------|-------|--|--|----|--|--|--|------------|--|--|--|--------|--------|--|--|--------------|--------------|--------------|--------------|-------------|-------------|-------------|-------------|
|  Instantaneous values | <table border="1"> <tr> <td>U</td> <td>U_MM</td> <td></td> <td></td> </tr> <tr> <td>UNE</td> <td>UNE_MAX</td> <td></td> <td></td> </tr> <tr> <td>I</td> <td>I_MAX</td> <td></td> <td></td> </tr> <tr> <td>F</td> <td>F_MM</td> <td></td> <td></td> </tr> <tr> <td>P</td> <td>P_MAX</td> <td></td> <td></td> </tr> <tr> <td>Q</td> <td>Q_MAX</td> <td></td> <td></td> </tr> <tr> <td>S</td> <td>S_MAX</td> <td></td> <td></td> </tr> <tr> <td>PF</td> <td></td> <td></td> <td></td> </tr> <tr> <td>P_TRIANGLE</td> <td></td> <td></td> <td></td> </tr> <tr> <td>PF_MIN</td> <td>Cφ_MIN</td> <td></td> <td></td> </tr> <tr> <td>I> 1.1 / 1.2</td> <td>I> 2.1 / 2.2</td> <td>I> 3.1 / 3.2</td> <td>I> 4.1 / 4.2</td> </tr> <tr> <td>ϑ 1.1 / 1.2</td> <td>ϑ 2.1 / 2.2</td> <td>ϑ 3.1 / 3.2</td> <td>ϑ 4.1 / 4.2</td> </tr> </table> | U | U_MM | | | UNE | UNE_MAX | | | I | I_MAX | | | F | F_MM | | | P | P_MAX | | | Q | Q_MAX | | | S | S_MAX | | | PF | | | | P_TRIANGLE | | | | PF_MIN | Cφ_MIN | | | I> 1.1 / 1.2 | I> 2.1 / 2.2 | I> 3.1 / 3.2 | I> 4.1 / 4.2 | ϑ 1.1 / 1.2 | ϑ 2.1 / 2.2 | ϑ 3.1 / 3.2 | ϑ 4.1 / 4.2 |
| U | U_MM | | | | | | | | | | | | | | | | | | | | | | | | | | | | | | | | | | | | | | | | | | | | | | | | |
| UNE | UNE_MAX | | | | | | | | | | | | | | | | | | | | | | | | | | | | | | | | | | | | | | | | | | | | | | | | |
| I | I_MAX | | | | | | | | | | | | | | | | | | | | | | | | | | | | | | | | | | | | | | | | | | | | | | | | |
| F | F_MM | | | | | | | | | | | | | | | | | | | | | | | | | | | | | | | | | | | | | | | | | | | | | | | | |
| P | P_MAX | | | | | | | | | | | | | | | | | | | | | | | | | | | | | | | | | | | | | | | | | | | | | | | | |
| Q | Q_MAX | | | | | | | | | | | | | | | | | | | | | | | | | | | | | | | | | | | | | | | | | | | | | | | | |
| S | S_MAX | | | | | | | | | | | | | | | | | | | | | | | | | | | | | | | | | | | | | | | | | | | | | | | | |
| PF | | | | | | | | | | | | | | | | | | | | | | | | | | | | | | | | | | | | | | | | | | | | | | | | | |
| P_TRIANGLE | | | | | | | | | | | | | | | | | | | | | | | | | | | | | | | | | | | | | | | | | | | | | | | | | |
| PF_MIN | Cφ_MIN | | | | | | | | | | | | | | | | | | | | | | | | | | | | | | | | | | | | | | | | | | | | | | | | |
| I> 1.1 / 1.2 | I> 2.1 / 2.2 | I> 3.1 / 3.2 | I> 4.1 / 4.2 | | | | | | | | | | | | | | | | | | | | | | | | | | | | | | | | | | | | | | | | | | | | | | |
| ϑ 1.1 / 1.2 | ϑ 2.1 / 2.2 | ϑ 3.1 / 3.2 | ϑ 4.1 / 4.2 | | | | | | | | | | | | | | | | | | | | | | | | | | | | | | | | | | | | | | | | | | | | | | |
|  Energy Meter contents Standard meters | <table border="1"> <tr> <td>ΣP_I_IV_HT</td> </tr> <tr> <td>ΣP_I_IV_NT</td> </tr> <tr> <td>ΣP_II_III_NT</td> </tr> <tr> <td>ΣP_II_III_HT</td> </tr> <tr> <td>ΣQ_I_II_HT</td> </tr> <tr> <td>ΣQ_I_II_NT</td> </tr> <tr> <td>ΣQ_III_IV_HT</td> </tr> <tr> <td>ΣQ_I_II_NT</td> </tr> </table> | ΣP_I_IV_HT | ΣP_I_IV_NT | ΣP_II_III_NT | ΣP_II_III_HT | ΣQ_I_II_HT | ΣQ_I_II_NT | ΣQ_III_IV_HT | ΣQ_I_II_NT | | | | | | | | | | | | | | | | | | | | | | | | | | | | | | | | | | | | | | | | |
| ΣP_I_IV_HT | | | | | | | | | | | | | | | | | | | | | | | | | | | | | | | | | | | | | | | | | | | | | | | | | |
| ΣP_I_IV_NT | | | | | | | | | | | | | | | | | | | | | | | | | | | | | | | | | | | | | | | | | | | | | | | | | |
| ΣP_II_III_NT | | | | | | | | | | | | | | | | | | | | | | | | | | | | | | | | | | | | | | | | | | | | | | | | | |
| ΣP_II_III_HT | | | | | | | | | | | | | | | | | | | | | | | | | | | | | | | | | | | | | | | | | | | | | | | | | |
| ΣQ_I_II_HT | | | | | | | | | | | | | | | | | | | | | | | | | | | | | | | | | | | | | | | | | | | | | | | | | |
| ΣQ_I_II_NT | | | | | | | | | | | | | | | | | | | | | | | | | | | | | | | | | | | | | | | | | | | | | | | | | |
| ΣQ_III_IV_HT | | | | | | | | | | | | | | | | | | | | | | | | | | | | | | | | | | | | | | | | | | | | | | | | | |
| ΣQ_I_II_NT | | | | | | | | | | | | | | | | | | | | | | | | | | | | | | | | | | | | | | | | | | | | | | | | | |
|  Energy Meter contents User meters | <table border="1"> <tr> <td>ΣMETER1</td> </tr> <tr> <td>ΣMETER2</td> </tr> <tr> <td>ΣMETER3</td> </tr> <tr> <td>ΣMETER4</td> </tr> <tr> <td>ΣMETER5</td> </tr> <tr> <td>ΣMETER6</td> </tr> <tr> <td>ΣMETER7</td> </tr> <tr> <td>ΣMETER8</td> </tr> <tr> <td>ΣMETER9</td> </tr> <tr> <td>ΣMETER10</td> </tr> <tr> <td>ΣMETER11</td> </tr> <tr> <td>ΣMETER12</td> </tr> </table> | ΣMETER1 | ΣMETER2 | ΣMETER3 | ΣMETER4 | ΣMETER5 | ΣMETER6 | ΣMETER7 | ΣMETER8 | ΣMETER9 | ΣMETER10 | ΣMETER11 | ΣMETER12 | | | | | | | | | | | | | | | | | | | | | | | | | | | | | | | | | | | | |
| ΣMETER1 | | | | | | | | | | | | | | | | | | | | | | | | | | | | | | | | | | | | | | | | | | | | | | | | | |
| ΣMETER2 | | | | | | | | | | | | | | | | | | | | | | | | | | | | | | | | | | | | | | | | | | | | | | | | | |
| ΣMETER3 | | | | | | | | | | | | | | | | | | | | | | | | | | | | | | | | | | | | | | | | | | | | | | | | | |
| ΣMETER4 | | | | | | | | | | | | | | | | | | | | | | | | | | | | | | | | | | | | | | | | | | | | | | | | | |
| ΣMETER5 | | | | | | | | | | | | | | | | | | | | | | | | | | | | | | | | | | | | | | | | | | | | | | | | | |
| ΣMETER6 | | | | | | | | | | | | | | | | | | | | | | | | | | | | | | | | | | | | | | | | | | | | | | | | | |
| ΣMETER7 | | | | | | | | | | | | | | | | | | | | | | | | | | | | | | | | | | | | | | | | | | | | | | | | | |
| ΣMETER8 | | | | | | | | | | | | | | | | | | | | | | | | | | | | | | | | | | | | | | | | | | | | | | | | | |
| ΣMETER9 | | | | | | | | | | | | | | | | | | | | | | | | | | | | | | | | | | | | | | | | | | | | | | | | | |
| ΣMETER10 | | | | | | | | | | | | | | | | | | | | | | | | | | | | | | | | | | | | | | | | | | | | | | | | | |
| ΣMETER11 | | | | | | | | | | | | | | | | | | | | | | | | | | | | | | | | | | | | | | | | | | | | | | | | | |
| ΣMETER12 | | | | | | | | | | | | | | | | | | | | | | | | | | | | | | | | | | | | | | | | | | | | | | | | | |
|  Energy Mean-values Power mean-values + trend | <table border="1"> <tr> <td>MT_P_I_IV</td> <td>MT_P_II_III</td> <td>MT_Q_I_II</td> <td>MT_Q_III_IV</td> <td>MT_S</td> </tr> </table> | MT_P_I_IV | MT_P_II_III | MT_Q_I_II | MT_Q_III_IV | MT_S | | | | | | | | | | | | | | | | | | | | | | | | | | | | | | | | | | | | | | | | | | | |
| MT_P_I_IV | MT_P_II_III | MT_Q_I_II | MT_Q_III_IV | MT_S | | | | | | | | | | | | | | | | | | | | | | | | | | | | | | | | | | | | | | | | | | | | | |
|  Energy Mean-values User mean-values + trend | <table border="1"> <tr> <td>M1 / TR_M1</td> <td>M1_MM</td> <td rowspan="12">For CU5000 divided into 2 images each</td> </tr> <tr> <td>M2 / TR_M2</td> <td>M2_MM</td> </tr> <tr> <td>M3 / TR_M3</td> <td>M3_MM</td> </tr> <tr> <td>M4 / TR_M4</td> <td>M4_MM</td> </tr> <tr> <td>M5 / TR_M5</td> <td>M5_MM</td> </tr> <tr> <td>M6 / TR_M6</td> <td>M6_MM</td> </tr> <tr> <td>M7 / TR_M7</td> <td>M7_MM</td> </tr> <tr> <td>M8 / TR_M8</td> <td>M8_MM</td> </tr> <tr> <td>M9 / TR_M9</td> <td>M9_MM</td> </tr> <tr> <td>M10 / TR_M10</td> <td>M10_MM</td> </tr> <tr> <td>M11 / TR_M11</td> <td>M11_MM</td> </tr> <tr> <td>M12 / TR_M12</td> <td>M12_MM</td> </tr> </table> | M1 / TR_M1 | M1_MM | For CU5000 divided into 2 images each | M2 / TR_M2 | M2_MM | M3 / TR_M3 | M3_MM | M4 / TR_M4 | M4_MM | M5 / TR_M5 | M5_MM | M6 / TR_M6 | M6_MM | M7 / TR_M7 | M7_MM | M8 / TR_M8 | M8_MM | M9 / TR_M9 | M9_MM | M10 / TR_M10 | M10_MM | M11 / TR_M11 | M11_MM | M12 / TR_M12 | M12_MM | | | | | | | | | | | | | | | | | | | | | | | |
| M1 / TR_M1 | M1_MM | For CU5000 divided into 2 images each | | | | | | | | | | | | | | | | | | | | | | | | | | | | | | | | | | | | | | | | | | | | | | | |
| M2 / TR_M2 | M2_MM | | | | | | | | | | | | | | | | | | | | | | | | | | | | | | | | | | | | | | | | | | | | | | | | |
| M3 / TR_M3 | M3_MM | | | | | | | | | | | | | | | | | | | | | | | | | | | | | | | | | | | | | | | | | | | | | | | | |
| M4 / TR_M4 | M4_MM | | | | | | | | | | | | | | | | | | | | | | | | | | | | | | | | | | | | | | | | | | | | | | | | |
| M5 / TR_M5 | M5_MM | | | | | | | | | | | | | | | | | | | | | | | | | | | | | | | | | | | | | | | | | | | | | | | | |
| M6 / TR_M6 | M6_MM | | | | | | | | | | | | | | | | | | | | | | | | | | | | | | | | | | | | | | | | | | | | | | | | |
| M7 / TR_M7 | M7_MM | | | | | | | | | | | | | | | | | | | | | | | | | | | | | | | | | | | | | | | | | | | | | | | | |
| M8 / TR_M8 | M8_MM | | | | | | | | | | | | | | | | | | | | | | | | | | | | | | | | | | | | | | | | | | | | | | | | |
| M9 / TR_M9 | M9_MM | | | | | | | | | | | | | | | | | | | | | | | | | | | | | | | | | | | | | | | | | | | | | | | | |
| M10 / TR_M10 | M10_MM | | | | | | | | | | | | | | | | | | | | | | | | | | | | | | | | | | | | | | | | | | | | | | | | |
| M11 / TR_M11 | M11_MM | | | | | | | | | | | | | | | | | | | | | | | | | | | | | | | | | | | | | | | | | | | | | | | | |
| M12 / TR_M12 | M12_MM | | | | | | | | | | | | | | | | | | | | | | | | | | | | | | | | | | | | | | | | | | | | | | | | |
|  Energy Bimetal current | <table border="1"> <tr> <td>IB</td> </tr> <tr> <td>IB_MAX</td> </tr> </table> | IB | IB_MAX | | | | | | | | | | | | | | | | | | | | | | | | | | | | | | | | | | | | | | | | | | | | | | |
| IB | | | | | | | | | | | | | | | | | | | | | | | | | | | | | | | | | | | | | | | | | | | | | | | | | |
| IB_MAX | | | | | | | | | | | | | | | | | | | | | | | | | | | | | | | | | | | | | | | | | | | | | | | | | |

B8 Display matrices for 4-wire systems, unbalanced load

| Display menu | Corresponding matrix | | | | | | | | | | | | | | | | | | | | | | | | | | | | | | | | | | | | | | | | | | | | | | | | | | | | | | | | | | | | | | | | | | | | | | | | | | | | | | | | | | | | | | | | | | | | | | | | |
|--|---|-------------------|-------------|-----------------|--------------|-------------|------------|--------------|-----------------|------------|----------|------------|----------|-----------------|-------|------------|-------|------------|-----------------|--------------|-------------|--------------|--------|-----------------|--------|-----|----|-----|------------------|--|-----|----|-----|-------------------|--|----|---|--|--|--|-------------|---|----|----|----|--------|--------|--------|---|----|----|----|--------|--------|--------|---|----|----|----|--------|--------|--------|----|---|---|---|-------|-------|-------|------------|--|-------------|--|-------------|--|-------------|--------|--|--------|--|--|--|--|-------------|--|-------------|--|-------------|--|-------------|-------------|--|-------------|--|-------------|--|-------------|
|  Instantaneous values | <table border="1"> <tr> <td>U1N</td> <td>U12</td> <td colspan="2">U1N_MM / U12_MM</td> <td>UR1</td> </tr> <tr> <td>U2N</td> <td>U23</td> <td colspan="2">U2N_MM / U23_MM</td> <td>UR2</td> </tr> <tr> <td>U3N</td> <td>U31</td> <td colspan="2">U3N_MM / U31_MM</td> <td>U0</td> </tr> <tr> <td>UNE</td> <td>F</td> <td colspan="2">F_MM / UR21_MAX</td> <td>UNB_UR2_UR1</td> </tr> <tr> <td>I1</td> <td>IN</td> <td colspan="2">I1_MAX / IN_MAX</td> <td>IR1</td> </tr> <tr> <td>I2</td> <td>IPE</td> <td colspan="2">I2_MAX / IPE_MAX</td> <td>IR2</td> </tr> <tr> <td>I3</td> <td>IMS</td> <td colspan="2">I3_MAX / IR21_MAX</td> <td>I0</td> </tr> <tr> <td>F</td> <td></td> <td colspan="2"></td> <td>UNB_IR2_IR1</td> </tr> <tr> <td>P</td> <td>P1</td> <td>Q1</td> <td>S1</td> <td>P1_MAX</td> <td>Q1_MAX</td> <td>S1_MAX</td> </tr> <tr> <td>Q</td> <td>P2</td> <td>Q2</td> <td>S2</td> <td>P2_MAX</td> <td>Q2_MAX</td> <td>S2_MAX</td> </tr> <tr> <td>S</td> <td>P3</td> <td>Q3</td> <td>S3</td> <td>P3_MAX</td> <td>Q3_MAX</td> <td>S3_MAX</td> </tr> <tr> <td>PF</td> <td>P</td> <td>Q</td> <td>S</td> <td>P_MAX</td> <td>Q_MAX</td> <td>S_MAX</td> </tr> <tr> <td colspan="2">P_TRIANGLE</td> <td colspan="2">P1_TRIANGLE</td> <td colspan="2">P2_TRIANGLE</td> <td>P3_TRIANGLE</td> </tr> <tr> <td colspan="2">PF_MIN</td> <td colspan="2">Cφ_MIN</td> <td colspan="3"></td> </tr> <tr> <td colspan="2"> > 1.1 / 1.2</td> <td colspan="2"> > 2.1 / 2.2</td> <td colspan="2"> > 3.1 / 3.2</td> <td> > 4.1 / 4.2</td> </tr> <tr> <td colspan="2">∅ 1.1 / 1.2</td> <td colspan="2">∅ 2.1 / 2.2</td> <td colspan="2">∅ 3.1 / 3.2</td> <td>∅ 4.1 / 4.2</td> </tr> </table> <p style="text-align: right; color: orange;">For CU5000 divided into 2 images each</p> | U1N | U12 | U1N_MM / U12_MM | | UR1 | U2N | U23 | U2N_MM / U23_MM | | UR2 | U3N | U31 | U3N_MM / U31_MM | | U0 | UNE | F | F_MM / UR21_MAX | | UNB_UR2_UR1 | I1 | IN | I1_MAX / IN_MAX | | IR1 | I2 | IPE | I2_MAX / IPE_MAX | | IR2 | I3 | IMS | I3_MAX / IR21_MAX | | I0 | F | | | | UNB_IR2_IR1 | P | P1 | Q1 | S1 | P1_MAX | Q1_MAX | S1_MAX | Q | P2 | Q2 | S2 | P2_MAX | Q2_MAX | S2_MAX | S | P3 | Q3 | S3 | P3_MAX | Q3_MAX | S3_MAX | PF | P | Q | S | P_MAX | Q_MAX | S_MAX | P_TRIANGLE | | P1_TRIANGLE | | P2_TRIANGLE | | P3_TRIANGLE | PF_MIN | | Cφ_MIN | | | | | > 1.1 / 1.2 | | > 2.1 / 2.2 | | > 3.1 / 3.2 | | > 4.1 / 4.2 | ∅ 1.1 / 1.2 | | ∅ 2.1 / 2.2 | | ∅ 3.1 / 3.2 | | ∅ 4.1 / 4.2 |
| U1N | U12 | U1N_MM / U12_MM | | UR1 | | | | | | | | | | | | | | | | | | | | | | | | | | | | | | | | | | | | | | | | | | | | | | | | | | | | | | | | | | | | | | | | | | | | | | | | | | | | | | | | | | | | | | | | | | | | | |
| U2N | U23 | U2N_MM / U23_MM | | UR2 | | | | | | | | | | | | | | | | | | | | | | | | | | | | | | | | | | | | | | | | | | | | | | | | | | | | | | | | | | | | | | | | | | | | | | | | | | | | | | | | | | | | | | | | | | | | | |
| U3N | U31 | U3N_MM / U31_MM | | U0 | | | | | | | | | | | | | | | | | | | | | | | | | | | | | | | | | | | | | | | | | | | | | | | | | | | | | | | | | | | | | | | | | | | | | | | | | | | | | | | | | | | | | | | | | | | | | |
| UNE | F | F_MM / UR21_MAX | | UNB_UR2_UR1 | | | | | | | | | | | | | | | | | | | | | | | | | | | | | | | | | | | | | | | | | | | | | | | | | | | | | | | | | | | | | | | | | | | | | | | | | | | | | | | | | | | | | | | | | | | | | |
| I1 | IN | I1_MAX / IN_MAX | | IR1 | | | | | | | | | | | | | | | | | | | | | | | | | | | | | | | | | | | | | | | | | | | | | | | | | | | | | | | | | | | | | | | | | | | | | | | | | | | | | | | | | | | | | | | | | | | | | |
| I2 | IPE | I2_MAX / IPE_MAX | | IR2 | | | | | | | | | | | | | | | | | | | | | | | | | | | | | | | | | | | | | | | | | | | | | | | | | | | | | | | | | | | | | | | | | | | | | | | | | | | | | | | | | | | | | | | | | | | | | |
| I3 | IMS | I3_MAX / IR21_MAX | | I0 | | | | | | | | | | | | | | | | | | | | | | | | | | | | | | | | | | | | | | | | | | | | | | | | | | | | | | | | | | | | | | | | | | | | | | | | | | | | | | | | | | | | | | | | | | | | | |
| F | | | | UNB_IR2_IR1 | | | | | | | | | | | | | | | | | | | | | | | | | | | | | | | | | | | | | | | | | | | | | | | | | | | | | | | | | | | | | | | | | | | | | | | | | | | | | | | | | | | | | | | | | | | | | |
| P | P1 | Q1 | S1 | P1_MAX | Q1_MAX | S1_MAX | | | | | | | | | | | | | | | | | | | | | | | | | | | | | | | | | | | | | | | | | | | | | | | | | | | | | | | | | | | | | | | | | | | | | | | | | | | | | | | | | | | | | | | | | | | |
| Q | P2 | Q2 | S2 | P2_MAX | Q2_MAX | S2_MAX | | | | | | | | | | | | | | | | | | | | | | | | | | | | | | | | | | | | | | | | | | | | | | | | | | | | | | | | | | | | | | | | | | | | | | | | | | | | | | | | | | | | | | | | | | | |
| S | P3 | Q3 | S3 | P3_MAX | Q3_MAX | S3_MAX | | | | | | | | | | | | | | | | | | | | | | | | | | | | | | | | | | | | | | | | | | | | | | | | | | | | | | | | | | | | | | | | | | | | | | | | | | | | | | | | | | | | | | | | | | | |
| PF | P | Q | S | P_MAX | Q_MAX | S_MAX | | | | | | | | | | | | | | | | | | | | | | | | | | | | | | | | | | | | | | | | | | | | | | | | | | | | | | | | | | | | | | | | | | | | | | | | | | | | | | | | | | | | | | | | | | | |
| P_TRIANGLE | | P1_TRIANGLE | | P2_TRIANGLE | | P3_TRIANGLE | | | | | | | | | | | | | | | | | | | | | | | | | | | | | | | | | | | | | | | | | | | | | | | | | | | | | | | | | | | | | | | | | | | | | | | | | | | | | | | | | | | | | | | | | | | |
| PF_MIN | | Cφ_MIN | | | | | | | | | | | | | | | | | | | | | | | | | | | | | | | | | | | | | | | | | | | | | | | | | | | | | | | | | | | | | | | | | | | | | | | | | | | | | | | | | | | | | | | | | | | | | | | |
| > 1.1 / 1.2 | | > 2.1 / 2.2 | | > 3.1 / 3.2 | | > 4.1 / 4.2 | | | | | | | | | | | | | | | | | | | | | | | | | | | | | | | | | | | | | | | | | | | | | | | | | | | | | | | | | | | | | | | | | | | | | | | | | | | | | | | | | | | | | | | | | | | |
| ∅ 1.1 / 1.2 | | ∅ 2.1 / 2.2 | | ∅ 3.1 / 3.2 | | ∅ 4.1 / 4.2 | | | | | | | | | | | | | | | | | | | | | | | | | | | | | | | | | | | | | | | | | | | | | | | | | | | | | | | | | | | | | | | | | | | | | | | | | | | | | | | | | | | | | | | | | | | |
|  Energy Meter contents Standard meters | <table border="1"> <tr> <td>ΣP_I_IV_HT</td> </tr> <tr> <td>ΣP_I_IV_NT</td> </tr> <tr> <td>ΣP_II_III_NT</td> </tr> <tr> <td>ΣP_II_III_HT</td> </tr> <tr> <td>ΣQ_I_II_HT</td> </tr> <tr> <td>ΣQ_I_II_NT</td> </tr> <tr> <td>ΣQ_III_IV_HT</td> </tr> <tr> <td>ΣQ_I_II_NT</td> </tr> </table> | ΣP_I_IV_HT | ΣP_I_IV_NT | ΣP_II_III_NT | ΣP_II_III_HT | ΣQ_I_II_HT | ΣQ_I_II_NT | ΣQ_III_IV_HT | ΣQ_I_II_NT | | | | | | | | | | | | | | | | | | | | | | | | | | | | | | | | | | | | | | | | | | | | | | | | | | | | | | | | | | | | | | | | | | | | | | | | | | | | | | | | | | | | | | | | |
| ΣP_I_IV_HT | | | | | | | | | | | | | | | | | | | | | | | | | | | | | | | | | | | | | | | | | | | | | | | | | | | | | | | | | | | | | | | | | | | | | | | | | | | | | | | | | | | | | | | | | | | | | | | | | |
| ΣP_I_IV_NT | | | | | | | | | | | | | | | | | | | | | | | | | | | | | | | | | | | | | | | | | | | | | | | | | | | | | | | | | | | | | | | | | | | | | | | | | | | | | | | | | | | | | | | | | | | | | | | | | |
| ΣP_II_III_NT | | | | | | | | | | | | | | | | | | | | | | | | | | | | | | | | | | | | | | | | | | | | | | | | | | | | | | | | | | | | | | | | | | | | | | | | | | | | | | | | | | | | | | | | | | | | | | | | | |
| ΣP_II_III_HT | | | | | | | | | | | | | | | | | | | | | | | | | | | | | | | | | | | | | | | | | | | | | | | | | | | | | | | | | | | | | | | | | | | | | | | | | | | | | | | | | | | | | | | | | | | | | | | | | |
| ΣQ_I_II_HT | | | | | | | | | | | | | | | | | | | | | | | | | | | | | | | | | | | | | | | | | | | | | | | | | | | | | | | | | | | | | | | | | | | | | | | | | | | | | | | | | | | | | | | | | | | | | | | | | |
| ΣQ_I_II_NT | | | | | | | | | | | | | | | | | | | | | | | | | | | | | | | | | | | | | | | | | | | | | | | | | | | | | | | | | | | | | | | | | | | | | | | | | | | | | | | | | | | | | | | | | | | | | | | | | |
| ΣQ_III_IV_HT | | | | | | | | | | | | | | | | | | | | | | | | | | | | | | | | | | | | | | | | | | | | | | | | | | | | | | | | | | | | | | | | | | | | | | | | | | | | | | | | | | | | | | | | | | | | | | | | | |
| ΣQ_I_II_NT | | | | | | | | | | | | | | | | | | | | | | | | | | | | | | | | | | | | | | | | | | | | | | | | | | | | | | | | | | | | | | | | | | | | | | | | | | | | | | | | | | | | | | | | | | | | | | | | | |
|  Energy Meter contents User meters | <table border="1"> <tr> <td>ΣMETER1</td> </tr> <tr> <td>ΣMETER2</td> </tr> <tr> <td>ΣMETER3</td> </tr> <tr> <td>ΣMETER4</td> </tr> <tr> <td>ΣMETER5</td> </tr> <tr> <td>ΣMETER6</td> </tr> <tr> <td>ΣMETER7</td> </tr> <tr> <td>ΣMETER8</td> </tr> <tr> <td>ΣMETER9</td> </tr> <tr> <td>ΣMETER10</td> </tr> <tr> <td>ΣMETER11</td> </tr> <tr> <td>ΣMETER12</td> </tr> </table> | ΣMETER1 | ΣMETER2 | ΣMETER3 | ΣMETER4 | ΣMETER5 | ΣMETER6 | ΣMETER7 | ΣMETER8 | ΣMETER9 | ΣMETER10 | ΣMETER11 | ΣMETER12 | | | | | | | | | | | | | | | | | | | | | | | | | | | | | | | | | | | | | | | | | | | | | | | | | | | | | | | | | | | | | | | | | | | | | | | | | | | | | | | | | | | | |
| ΣMETER1 | | | | | | | | | | | | | | | | | | | | | | | | | | | | | | | | | | | | | | | | | | | | | | | | | | | | | | | | | | | | | | | | | | | | | | | | | | | | | | | | | | | | | | | | | | | | | | | | | |
| ΣMETER2 | | | | | | | | | | | | | | | | | | | | | | | | | | | | | | | | | | | | | | | | | | | | | | | | | | | | | | | | | | | | | | | | | | | | | | | | | | | | | | | | | | | | | | | | | | | | | | | | | |
| ΣMETER3 | | | | | | | | | | | | | | | | | | | | | | | | | | | | | | | | | | | | | | | | | | | | | | | | | | | | | | | | | | | | | | | | | | | | | | | | | | | | | | | | | | | | | | | | | | | | | | | | | |
| ΣMETER4 | | | | | | | | | | | | | | | | | | | | | | | | | | | | | | | | | | | | | | | | | | | | | | | | | | | | | | | | | | | | | | | | | | | | | | | | | | | | | | | | | | | | | | | | | | | | | | | | | |
| ΣMETER5 | | | | | | | | | | | | | | | | | | | | | | | | | | | | | | | | | | | | | | | | | | | | | | | | | | | | | | | | | | | | | | | | | | | | | | | | | | | | | | | | | | | | | | | | | | | | | | | | | |
| ΣMETER6 | | | | | | | | | | | | | | | | | | | | | | | | | | | | | | | | | | | | | | | | | | | | | | | | | | | | | | | | | | | | | | | | | | | | | | | | | | | | | | | | | | | | | | | | | | | | | | | | | |
| ΣMETER7 | | | | | | | | | | | | | | | | | | | | | | | | | | | | | | | | | | | | | | | | | | | | | | | | | | | | | | | | | | | | | | | | | | | | | | | | | | | | | | | | | | | | | | | | | | | | | | | | | |
| ΣMETER8 | | | | | | | | | | | | | | | | | | | | | | | | | | | | | | | | | | | | | | | | | | | | | | | | | | | | | | | | | | | | | | | | | | | | | | | | | | | | | | | | | | | | | | | | | | | | | | | | | |
| ΣMETER9 | | | | | | | | | | | | | | | | | | | | | | | | | | | | | | | | | | | | | | | | | | | | | | | | | | | | | | | | | | | | | | | | | | | | | | | | | | | | | | | | | | | | | | | | | | | | | | | | | |
| ΣMETER10 | | | | | | | | | | | | | | | | | | | | | | | | | | | | | | | | | | | | | | | | | | | | | | | | | | | | | | | | | | | | | | | | | | | | | | | | | | | | | | | | | | | | | | | | | | | | | | | | | |
| ΣMETER11 | | | | | | | | | | | | | | | | | | | | | | | | | | | | | | | | | | | | | | | | | | | | | | | | | | | | | | | | | | | | | | | | | | | | | | | | | | | | | | | | | | | | | | | | | | | | | | | | | |
| ΣMETER12 | | | | | | | | | | | | | | | | | | | | | | | | | | | | | | | | | | | | | | | | | | | | | | | | | | | | | | | | | | | | | | | | | | | | | | | | | | | | | | | | | | | | | | | | | | | | | | | | | |
|  Energy Mean-values Power mean-values + trend | <table border="1"> <tr> <td>MT_P_I_IV</td> <td>MT_P_II_III</td> <td>MT_Q_I_II</td> <td>MT_Q_III_IV</td> <td>MT_S</td> </tr> </table> | MT_P_I_IV | MT_P_II_III | MT_Q_I_II | MT_Q_III_IV | MT_S | | | | | | | | | | | | | | | | | | | | | | | | | | | | | | | | | | | | | | | | | | | | | | | | | | | | | | | | | | | | | | | | | | | | | | | | | | | | | | | | | | | | | | | | | | | |
| MT_P_I_IV | MT_P_II_III | MT_Q_I_II | MT_Q_III_IV | MT_S | | | | | | | | | | | | | | | | | | | | | | | | | | | | | | | | | | | | | | | | | | | | | | | | | | | | | | | | | | | | | | | | | | | | | | | | | | | | | | | | | | | | | | | | | | | | | |
|  Energy Mean-values User mean-values + trend | <table border="1"> <tr> <td>M1 / TR_M1</td> <td>M1_MM</td> </tr> <tr> <td>M2 / TR_M2</td> <td>M2_MM</td> </tr> <tr> <td>M3 / TR_M3</td> <td>M3_MM</td> </tr> <tr> <td>M4 / TR_M4</td> <td>M4_MM</td> </tr> <tr> <td>M5 / TR_M5</td> <td>M5_MM</td> </tr> <tr> <td>M6 / TR_M6</td> <td>M6_MM</td> </tr> <tr> <td>M7 / TR_M7</td> <td>M7_MM</td> </tr> <tr> <td>M8 / TR_M8</td> <td>M8_MM</td> </tr> <tr> <td>M9 / TR_M9</td> <td>M9_MM</td> </tr> <tr> <td>M10 / TR_M10</td> <td>M10_MM</td> </tr> <tr> <td>M11 / TR_M11</td> <td>M11_MM</td> </tr> <tr> <td>M12 / TR_M12</td> <td>M12_MM</td> </tr> </table> <p style="text-align: right; color: orange;">For CU5000 divided into 2 images each</p> | M1 / TR_M1 | M1_MM | M2 / TR_M2 | M2_MM | M3 / TR_M3 | M3_MM | M4 / TR_M4 | M4_MM | M5 / TR_M5 | M5_MM | M6 / TR_M6 | M6_MM | M7 / TR_M7 | M7_MM | M8 / TR_M8 | M8_MM | M9 / TR_M9 | M9_MM | M10 / TR_M10 | M10_MM | M11 / TR_M11 | M11_MM | M12 / TR_M12 | M12_MM | | | | | | | | | | | | | | | | | | | | | | | | | | | | | | | | | | | | | | | | | | | | | | | | | | | | | | | | | | | | | | | | | | | | | | | | |
| M1 / TR_M1 | M1_MM | | | | | | | | | | | | | | | | | | | | | | | | | | | | | | | | | | | | | | | | | | | | | | | | | | | | | | | | | | | | | | | | | | | | | | | | | | | | | | | | | | | | | | | | | | | | | | | | |
| M2 / TR_M2 | M2_MM | | | | | | | | | | | | | | | | | | | | | | | | | | | | | | | | | | | | | | | | | | | | | | | | | | | | | | | | | | | | | | | | | | | | | | | | | | | | | | | | | | | | | | | | | | | | | | | | |
| M3 / TR_M3 | M3_MM | | | | | | | | | | | | | | | | | | | | | | | | | | | | | | | | | | | | | | | | | | | | | | | | | | | | | | | | | | | | | | | | | | | | | | | | | | | | | | | | | | | | | | | | | | | | | | | | |
| M4 / TR_M4 | M4_MM | | | | | | | | | | | | | | | | | | | | | | | | | | | | | | | | | | | | | | | | | | | | | | | | | | | | | | | | | | | | | | | | | | | | | | | | | | | | | | | | | | | | | | | | | | | | | | | | |
| M5 / TR_M5 | M5_MM | | | | | | | | | | | | | | | | | | | | | | | | | | | | | | | | | | | | | | | | | | | | | | | | | | | | | | | | | | | | | | | | | | | | | | | | | | | | | | | | | | | | | | | | | | | | | | | | |
| M6 / TR_M6 | M6_MM | | | | | | | | | | | | | | | | | | | | | | | | | | | | | | | | | | | | | | | | | | | | | | | | | | | | | | | | | | | | | | | | | | | | | | | | | | | | | | | | | | | | | | | | | | | | | | | | |
| M7 / TR_M7 | M7_MM | | | | | | | | | | | | | | | | | | | | | | | | | | | | | | | | | | | | | | | | | | | | | | | | | | | | | | | | | | | | | | | | | | | | | | | | | | | | | | | | | | | | | | | | | | | | | | | | |
| M8 / TR_M8 | M8_MM | | | | | | | | | | | | | | | | | | | | | | | | | | | | | | | | | | | | | | | | | | | | | | | | | | | | | | | | | | | | | | | | | | | | | | | | | | | | | | | | | | | | | | | | | | | | | | | | |
| M9 / TR_M9 | M9_MM | | | | | | | | | | | | | | | | | | | | | | | | | | | | | | | | | | | | | | | | | | | | | | | | | | | | | | | | | | | | | | | | | | | | | | | | | | | | | | | | | | | | | | | | | | | | | | | | |
| M10 / TR_M10 | M10_MM | | | | | | | | | | | | | | | | | | | | | | | | | | | | | | | | | | | | | | | | | | | | | | | | | | | | | | | | | | | | | | | | | | | | | | | | | | | | | | | | | | | | | | | | | | | | | | | | |
| M11 / TR_M11 | M11_MM | | | | | | | | | | | | | | | | | | | | | | | | | | | | | | | | | | | | | | | | | | | | | | | | | | | | | | | | | | | | | | | | | | | | | | | | | | | | | | | | | | | | | | | | | | | | | | | | |
| M12 / TR_M12 | M12_MM | | | | | | | | | | | | | | | | | | | | | | | | | | | | | | | | | | | | | | | | | | | | | | | | | | | | | | | | | | | | | | | | | | | | | | | | | | | | | | | | | | | | | | | | | | | | | | | | |
|  Energy Bimetal current | <table border="1"> <tr> <td>IB1</td> <td>IB1_MAX</td> </tr> <tr> <td>IB2</td> <td>IB2_MAX</td> </tr> <tr> <td>IB3</td> <td>IB3_MAX</td> </tr> </table> | IB1 | IB1_MAX | IB2 | IB2_MAX | IB3 | IB3_MAX | | | | | | | | | | | | | | | | | | | | | | | | | | | | | | | | | | | | | | | | | | | | | | | | | | | | | | | | | | | | | | | | | | | | | | | | | | | | | | | | | | | | | | | | | | |
| IB1 | IB1_MAX | | | | | | | | | | | | | | | | | | | | | | | | | | | | | | | | | | | | | | | | | | | | | | | | | | | | | | | | | | | | | | | | | | | | | | | | | | | | | | | | | | | | | | | | | | | | | | | | |
| IB2 | IB2_MAX | | | | | | | | | | | | | | | | | | | | | | | | | | | | | | | | | | | | | | | | | | | | | | | | | | | | | | | | | | | | | | | | | | | | | | | | | | | | | | | | | | | | | | | | | | | | | | | | |
| IB3 | IB3_MAX | | | | | | | | | | | | | | | | | | | | | | | | | | | | | | | | | | | | | | | | | | | | | | | | | | | | | | | | | | | | | | | | | | | | | | | | | | | | | | | | | | | | | | | | | | | | | | | | |

B9 Display matrices for 4-wire system, unbalanced load, Open-Y

| Display menu | Corresponding matrix | | | | | | | | | | | | | | | | | | | | | | | | | | | | | | | | | | | | | | | | |
|--|---|---|---|---|--|----------------------------------|--|-------------------------------------|--|---------------------------------|--|-------------------|---------------------|---------------------|---------------------|-------------------------------------|--|--|-------------------------------------|-------------------------------------|--|------------|-------------|-------------|-------------|--|--------|--------|--|--|--|---------------|---------------|---------------|---------------|--|---------------|---------------|---------------|---------------|--|
|  Instantaneous values | <table border="1"> <tr> <td>U1N U2N U3N UNE</td> <td>U12 U23 U31 F</td> <td>U1N_MM / U12_MM U2N_MM / U23_MM U3N_MM / U31_MM UNE_MAX / F_MM</td> <td colspan="2">For CU5000 divided into 2 images each</td> </tr> <tr> <td>I1 I2 I3 F</td> <td>IN IPE IMS</td> <td>I1_MAX / IN_MAX I2_MAX / IPE_MAX I3_MAX / IR21_MAX</td> <td>IR1 IR2 I0 UNB_IR2_IR1</td> <td></td> </tr> <tr> <td>P Q S PF</td> <td>P1 P2 P3 P</td> <td>Q1 Q2 Q3 Q</td> <td>S1 S2 S3 S</td> <td>P1_MAX P2_MAX P3_MAX P_MAX</td> </tr> <tr> <td></td> <td></td> <td>Q1_MAX Q2_MAX Q3_MAX Q_MAX</td> <td>S1_MAX S2_MAX S3_MAX S_MAX</td> <td></td> </tr> <tr> <td>P_TRIANGLE</td> <td>P1_TRIANGLE</td> <td>P2_TRIANGLE</td> <td colspan="2">P3_TRIANGLE</td> </tr> <tr> <td>PF_MIN</td> <td>Cφ_MIN</td> <td></td> <td></td> <td></td> </tr> <tr> <td>I > 1.1 / 1.2</td> <td>I > 2.1 / 2.2</td> <td>I > 3.1 / 3.2</td> <td colspan="2">I > 4.1 / 4.2</td> </tr> <tr> <td>I ≥ 1.1 / 1.2</td> <td>I ≥ 2.1 / 2.2</td> <td>I ≥ 3.1 / 3.2</td> <td colspan="2">I ≥ 4.1 / 4.2</td> </tr> </table> | U1N U2N U3N UNE | U12 U23 U31 F | U1N_MM / U12_MM U2N_MM / U23_MM U3N_MM / U31_MM UNE_MAX / F_MM | For CU5000 divided into 2 images each | | I1 I2 I3 F | IN IPE IMS | I1_MAX / IN_MAX I2_MAX / IPE_MAX I3_MAX / IR21_MAX | IR1 IR2 I0 UNB_IR2_IR1 | | P Q S PF | P1 P2 P3 P | Q1 Q2 Q3 Q | S1 S2 S3 S | P1_MAX P2_MAX P3_MAX P_MAX | | | Q1_MAX Q2_MAX Q3_MAX Q_MAX | S1_MAX S2_MAX S3_MAX S_MAX | | P_TRIANGLE | P1_TRIANGLE | P2_TRIANGLE | P3_TRIANGLE | | PF_MIN | Cφ_MIN | | | | I > 1.1 / 1.2 | I > 2.1 / 2.2 | I > 3.1 / 3.2 | I > 4.1 / 4.2 | | I ≥ 1.1 / 1.2 | I ≥ 2.1 / 2.2 | I ≥ 3.1 / 3.2 | I ≥ 4.1 / 4.2 | |
| U1N U2N U3N UNE | U12 U23 U31 F | U1N_MM / U12_MM U2N_MM / U23_MM U3N_MM / U31_MM UNE_MAX / F_MM | For CU5000 divided into 2 images each | | | | | | | | | | | | | | | | | | | | | | | | | | | | | | | | | | | | | | |
| I1 I2 I3 F | IN IPE IMS | I1_MAX / IN_MAX I2_MAX / IPE_MAX I3_MAX / IR21_MAX | IR1 IR2 I0 UNB_IR2_IR1 | | | | | | | | | | | | | | | | | | | | | | | | | | | | | | | | | | | | | | |
| P Q S PF | P1 P2 P3 P | Q1 Q2 Q3 Q | S1 S2 S3 S | P1_MAX P2_MAX P3_MAX P_MAX | | | | | | | | | | | | | | | | | | | | | | | | | | | | | | | | | | | | | |
| | | Q1_MAX Q2_MAX Q3_MAX Q_MAX | S1_MAX S2_MAX S3_MAX S_MAX | | | | | | | | | | | | | | | | | | | | | | | | | | | | | | | | | | | | | | |
| P_TRIANGLE | P1_TRIANGLE | P2_TRIANGLE | P3_TRIANGLE | | | | | | | | | | | | | | | | | | | | | | | | | | | | | | | | | | | | | | |
| PF_MIN | Cφ_MIN | | | | | | | | | | | | | | | | | | | | | | | | | | | | | | | | | | | | | | | | |
| I > 1.1 / 1.2 | I > 2.1 / 2.2 | I > 3.1 / 3.2 | I > 4.1 / 4.2 | | | | | | | | | | | | | | | | | | | | | | | | | | | | | | | | | | | | | | |
| I ≥ 1.1 / 1.2 | I ≥ 2.1 / 2.2 | I ≥ 3.1 / 3.2 | I ≥ 4.1 / 4.2 | | | | | | | | | | | | | | | | | | | | | | | | | | | | | | | | | | | | | | |
|  Energy Meter contents Standard meters | <table border="1"> <tr> <td>ΣP_I_IV_HT ΣP_I_IV_NT ΣP_II_III_NT ΣP_II_III_HT ΣQ_I_II_HT ΣQ_I_II_NT ΣQ_III_IV_HT ΣQ_I_II_NT</td> </tr> </table> | ΣP_I_IV_HT ΣP_I_IV_NT ΣP_II_III_NT ΣP_II_III_HT ΣQ_I_II_HT ΣQ_I_II_NT ΣQ_III_IV_HT ΣQ_I_II_NT | | | | | | | | | | | | | | | | | | | | | | | | | | | | | | | | | | | | | | | |
| ΣP_I_IV_HT ΣP_I_IV_NT ΣP_II_III_NT ΣP_II_III_HT ΣQ_I_II_HT ΣQ_I_II_NT ΣQ_III_IV_HT ΣQ_I_II_NT | | | | | | | | | | | | | | | | | | | | | | | | | | | | | | | | | | | | | | | | | |
|  Energy Meter contents User meters | <table border="1"> <tr> <td>ΣMETER1 ΣMETER2 ΣMETER3 ΣMETER4 ΣMETER5 ΣMETER6 ΣMETER7 ΣMETER8 ΣMETER9 ΣMETER10 ΣMETER11 ΣMETER12</td> </tr> </table> | ΣMETER1 ΣMETER2 ΣMETER3 ΣMETER4 ΣMETER5 ΣMETER6 ΣMETER7 ΣMETER8 ΣMETER9 ΣMETER10 ΣMETER11 ΣMETER12 | | | | | | | | | | | | | | | | | | | | | | | | | | | | | | | | | | | | | | | |
| ΣMETER1 ΣMETER2 ΣMETER3 ΣMETER4 ΣMETER5 ΣMETER6 ΣMETER7 ΣMETER8 ΣMETER9 ΣMETER10 ΣMETER11 ΣMETER12 | | | | | | | | | | | | | | | | | | | | | | | | | | | | | | | | | | | | | | | | | |
|  Energy Mean-values Power mean-values + trend | <table border="1"> <tr> <td>MT_P_I_IV</td> <td>MT_P_II_III</td> <td>MT_Q_I_II</td> <td>MT_Q_III_IV</td> <td>MT_S</td> </tr> </table> | MT_P_I_IV | MT_P_II_III | MT_Q_I_II | MT_Q_III_IV | MT_S | | | | | | | | | | | | | | | | | | | | | | | | | | | | | | | | | | | |
| MT_P_I_IV | MT_P_II_III | MT_Q_I_II | MT_Q_III_IV | MT_S | | | | | | | | | | | | | | | | | | | | | | | | | | | | | | | | | | | | | |
|  Energy Mean-values User mean-values + trend | <table border="1"> <tr> <td>M1 / TR_M1 M2 / TR_M2 M3 / TR_M3 M4 / TR_M4</td> <td>M1_MM M2_MM M3_MM M4_MM</td> <td rowspan="12">For CU5000 divided into 2 images each</td> </tr> <tr> <td>M5 / TR_M5 M6 / TR_M6 M7 / TR_M7 M8 / TR_M8</td> <td>M5_MM M6_MM M7_MM M8_MM</td> </tr> <tr> <td>M9 / TR_M9 M10 / TR_M10 M11 / TR_M11 M12 / TR_M12</td> <td>M9_MM M10_MM M11_MM M12_MM</td> </tr> </table> | M1 / TR_M1 M2 / TR_M2 M3 / TR_M3 M4 / TR_M4 | M1_MM M2_MM M3_MM M4_MM | For CU5000 divided into 2 images each | M5 / TR_M5 M6 / TR_M6 M7 / TR_M7 M8 / TR_M8 | M5_MM M6_MM M7_MM M8_MM | M9 / TR_M9 M10 / TR_M10 M11 / TR_M11 M12 / TR_M12 | M9_MM M10_MM M11_MM M12_MM | | | | | | | | | | | | | | | | | | | | | | | | | | | | | | | | | |
| M1 / TR_M1 M2 / TR_M2 M3 / TR_M3 M4 / TR_M4 | M1_MM M2_MM M3_MM M4_MM | For CU5000 divided into 2 images each | | | | | | | | | | | | | | | | | | | | | | | | | | | | | | | | | | | | | | | |
| M5 / TR_M5 M6 / TR_M6 M7 / TR_M7 M8 / TR_M8 | M5_MM M6_MM M7_MM M8_MM | | | | | | | | | | | | | | | | | | | | | | | | | | | | | | | | | | | | | | | | |
| M9 / TR_M9 M10 / TR_M10 M11 / TR_M11 M12 / TR_M12 | M9_MM M10_MM M11_MM M12_MM | | | | | | | | | | | | | | | | | | | | | | | | | | | | | | | | | | | | | | | | |
|  Energy Bimetal current | <table border="1"> <tr> <td>IB1 IB2 IB3</td> <td>IB1_MAX IB2_MAX IB3_MAX</td> </tr> </table> | | IB1 IB2 IB3 | | IB1_MAX IB2_MAX IB3_MAX | | | | | | | | | | | | | | | | | | | | | | | | | | | | | | | | | | | | |
| IB1 IB2 IB3 | IB1_MAX IB2_MAX IB3_MAX | | | | | | | | | | | | | | | | | | | | | | | | | | | | | | | | | | | | | | | | |

C Logic functions

The principal function of the logical gates is given in the following table, for simplicity shown for gates with two inputs only.

| function | symbol | older symbols | | truth table | plain text |
|-------------|--------|---------------|-----------------|----------------------------|--|
| | | ANSI 91-1984 | DIN 40700 (alt) | | |
| AND | | | | A B Y | Function is true if all input conditions are fulfilled |
| | | | | 0 0 0 | |
| | | | | 0 1 0 | |
| | | | | 1 0 0 | |
| | | | | 1 1 1 | |
| NAND | | | | A B Y | Function is true if at least one of the input conditions is not fulfilled |
| | | | | 0 0 1 | |
| | | | | 0 1 1 | |
| | | | | 1 0 1 | |
| | | | | 1 1 0 | |
| OR | | | | A B Y | Function is true if at least one of the input conditions is fulfilled |
| | | | | 0 0 0 | |
| | | | | 0 1 1 | |
| | | | | 1 0 1 | |
| | | | | 1 1 1 | |
| NOR | | | | A B Y | Function is true if none of the input conditions is fulfilled |
| | | | | 0 0 1 | |
| | | | | 0 1 0 | |
| | | | | 1 0 0 | |
| | | | | 1 1 0 | |

Using DIRECT or INVERT the input is directly connected to the output of a monitoring function, without need for a logical combination. For these functions only one input is used.

| DIRECT | | <table border="1"> <thead> <tr> <th>A</th> <th>Y</th> </tr> </thead> <tbody> <tr> <td>0</td> <td>0</td> </tr> <tr> <td>1</td> <td>1</td> </tr> </tbody> </table> | A | Y | 0 | 0 | 1 | 1 | The monitoring function is reduced to one input only. The state of the output corresponds to the input. |
|---------------|---|--|---|---|---|---|---|---|--|
| A | Y | | | | | | | | |
| 0 | 0 | | | | | | | | |
| 1 | 1 | | | | | | | | |
| INVERT | | <table border="1"> <thead> <tr> <th>A</th> <th>Y</th> </tr> </thead> <tbody> <tr> <td>0</td> <td>1</td> </tr> <tr> <td>1</td> <td>0</td> </tr> </tbody> </table> | A | Y | 0 | 1 | 1 | 0 | The monitoring function is reduced to one input only. The state of the output corresponds to the inverted input. |
| A | Y | | | | | | | | |
| 0 | 1 | | | | | | | | |
| 1 | 0 | | | | | | | | |

D FCC statement

The following statement applies to the products covered in this manual, unless otherwise specified herein. The statement for other products will appear in the accompanying documentation.

NOTE: This equipment has been tested and found to comply with the limits for a Class A digital device, pursuant to Part 15 of the FCC Rules and meets all requirements of the Canadian Interference-Causing Equipment Standard ICES-003 for digital apparatus. These limits are designed to provide reasonable protection against harmful interference in a residential installation. This equipment generates, uses, and can radiate radio frequency energy and, if not installed and used in accordance with the instructions, may cause harmful interference to radio communications. However, there is no guarantee that interference will not occur in a particular installation. If this equipment does cause harmful interference to radio or television reception, which can be determined by turning the equipment off and on, the user is encouraged to try to correct the interference by one or more of the following measures:

- Reorient or relocate the receiving antenna.
- Increase the separation between the equipment and receiver.
- Connect the equipment into an outlet on a circuit different from that to which the receiver is connected.
- Consult the dealer or an experienced radio/T.V. technician for help.

Camille Bauer AG is not responsible for any radio television interference caused by unauthorized modifications of this equipment or the substitution or attachment of connecting cables and equipment other than those specified by Camille Bauer AG. The correction of interference caused by such unauthorized modification, substitution or attachment will be the responsibility of the user.

INDEX

| | | | |
|----------------------------------|-----|--|-----|
| C | | | |
| CODESYS..... | 71 | Basic measurements..... | |
| Commissioning..... | 34 | 99 | |
| Configuration | | Bimetal current..... | |
| menu..... | 54 | 105 | |
| cosφ..... | 100 | earth fault monitoring..... | |
| | | 102 | |
| D | | harmonic analysis..... | |
| Demounting..... | 9 | 103 | |
| Device overview..... | 6 | Load factors..... | |
| Dimensional drawing..... | 98 | 105 | |
| Display matrices..... | 107 | mean values and trend..... | |
| Disturbance recorder..... | 65 | 105 | |
| Driving a counter mechanism..... | 27 | meters..... | |
| | | 106 | |
| E | | system imbalance..... | |
| Electrical connections | | 104 | |
| analog outputs..... | 27 | zero displacement voltage..... | |
| Aron connection..... | 21 | 102 | |
| cross sections..... | 12 | Measurement displays..... | |
| digital input..... | 25 | 52 | |
| digital output..... | 26 | Measurements | |
| inputs..... | 13 | reset..... | |
| Modbus interface..... | 31 | 54 | |
| Open-Y..... | 23 | Mechanical mounting..... | |
| power supply..... | 25 | 8 | |
| relays..... | 25 | Menu operation..... | |
| split phase..... | 24 | 51 | |
| Ethernet | | Mounting..... | |
| LEDs..... | 40 | 8 | |
| Ethernet installation..... | 37 | | |
| | | N | |
| F | | NTP..... | 39 |
| Fault current..... | 28 | O | |
| FCC statement..... | 122 | Operating elements..... | 51 |
| Firewall..... | 39 | P | |
| | | PQDIF..... | 68 |
| G | | R | |
| GPS..... | 32 | RCM..... | 28 |
| | | Reactive power..... | 101 |
| H | | Resetting measurements..... | 54 |
| HTTPS..... | 48 | Roman numbers..... | 53 |
| | | S | |
| I | | Safety notes..... | 6 |
| I, II, III, IV..... | 53 | Scope of supply..... | 5 |
| IEC61850..... | 42 | SD card | |
| Installation check..... | 35 | Exchange..... | 67 |
| | | LED..... | 67 |
| L | | SD-Card..... | 67 |
| Logic components | | Security system..... | 42 |
| AND..... | 121 | Service and maintenance..... | 90 |
| DIRECT..... | 121 | Summary alarm..... | 60 |
| INVERT..... | 121 | Symbols..... | 53 |
| NAND..... | 121 | Symmetrical components..... | 104 |
| NOR..... | 121 | SYSLOG..... | 49 |
| OR..... | 121 | T | |
| Logic functions..... | 121 | Technical data..... | 91 |
| | | temperature inputs..... | 30 |
| M | | Time synchronization | |
| Measured quantities..... | 99 | GPS..... | 32 |
| | | NTP..... | 39 |
| | | U | |
| | | UPS (Uninterruptible power supply)..... | 31 |
| | | W | |
| | | Whitelist..... | 48 |
| | | Z | |
| | | Zero suppression..... | 92 |